



Judicial Council of California

455 Golden Gate Avenue · San Francisco, California 94102-3688

www.courts.ca.gov/policyadmin-invitationstocomment.htm

INVITATION TO COMMENT

SP24-05

Title

Update to the *California Trial Court Facilities Standards*

Action Requested

Review and submit comments by June 6, 2024, for CFAC review

Proposed Rules, Forms, Standards, or Statutes

None

Contact

Chris Magnusson, 415-865-4041
chris.magnusson@jud.ca.gov

Proposed by

Court Facilities Advisory Committee
Hon. Brad R. Hill, Chair
Hon. Patricia M. Lucas (Ret.), Vice-Chair

Summary and Committee Action

The Judicial Council, with recommendation from its Court Facilities Advisory Committee (CFAC), approves updates to the *California Trial Court Facilities Standards*, which define the minimum space and the functional, technical, and security requirements for the design of trial court facilities in the state of California. They reflect best practices and successful solutions as the basis for design and construction of functional, durable, maintainable, efficient, and secure contemporary court facilities. Various code provisions and best management practices change over time and since the last version was adopted by the Judicial Council in November 2020.

Proposed edits to the current standards are reflected in the attached version and were approved for public comment by the CFAC at its public meeting on May 2, 2024. For reference, those meeting materials, including presentation slides, are available at www.courts.ca.gov/documents/cfac-20240502-materials.pdf.

The CFAC will meet next in early-August 2024 to review public comments received before making a final recommendation to the Judicial Council.

This proposal has not been approved by the Judicial Council and is not intended to represent the views of the council, its Rules Committee, or its Legislation Committee. It is circulated for comment purposes only.



JUDICIAL COUNCIL
OF CALIFORNIA

CALIFORNIA TRIAL COURT FACILITIES STANDARDS

2023 Edition

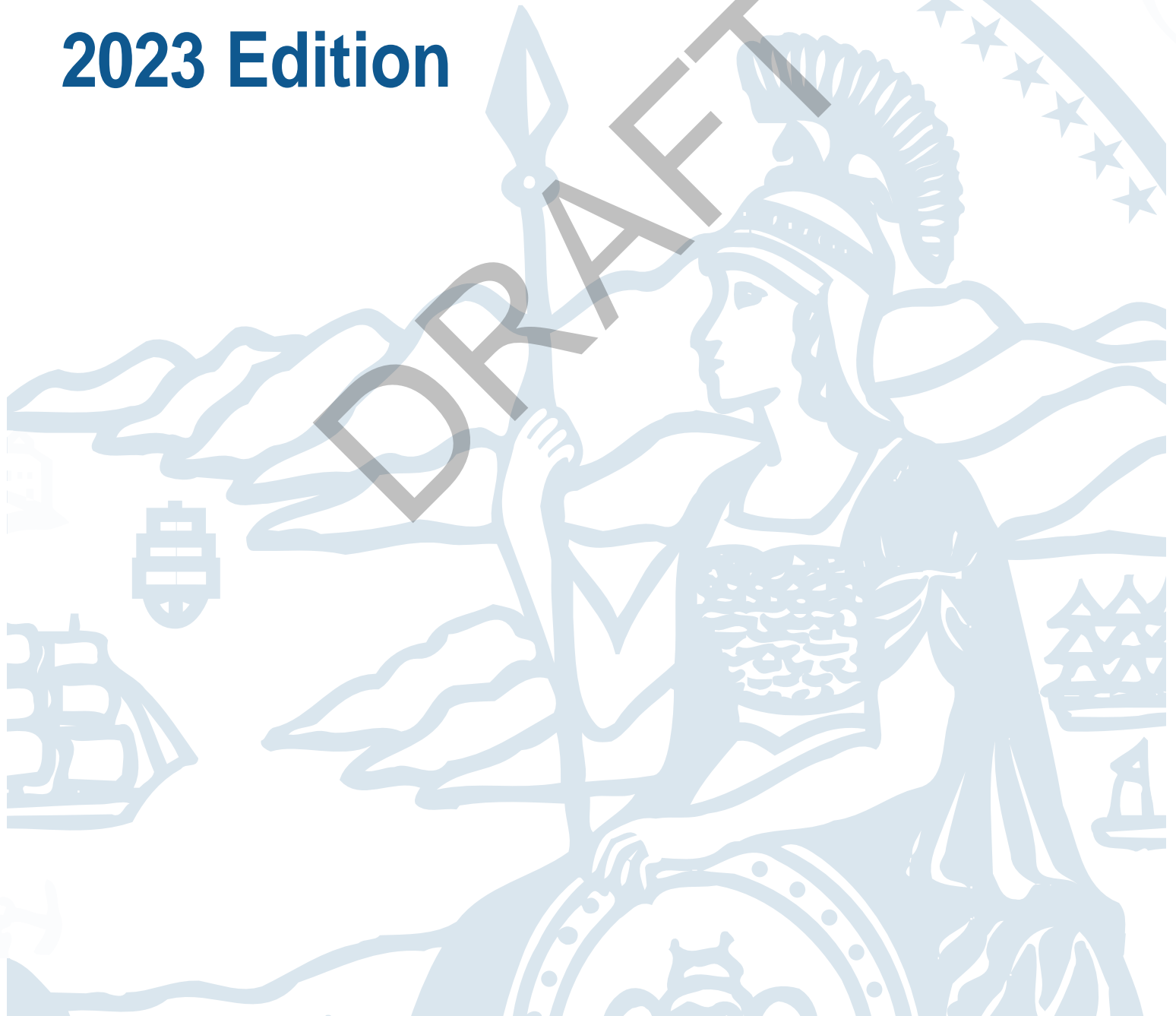

DRAFT



JUDICIAL COUNCIL
OF CALIFORNIA

CALIFORNIA TRIAL COURT FACILITIES STANDARDS 2023 Edition

Published by the Judicial Council of California
Administrative Division, Facilities Services
455 Golden Gate Avenue
San Francisco, CA 94102-3688

Copyright © 2023 by Judicial Council of California. All rights reserved.

Except as permitted under the Copyright Act of 1976 and as otherwise expressly provided herein, no part of this publication may be reproduced in any form or by any means, electronic, online, or mechanical, including the use of information storage and retrieval systems, without permission from the copyright holder.

TABLE OF CONTENTS

Prefacevii

DIVISION ONE: DESIGN CRITERIA

	PAGE		PAGE
1 GENERAL PRINCIPLES		6 JURY FACILITIES AND COURT ADMINISTRATION	
1.A Functional Usefulness, Physical Durability, and Maintainability	1.2	6.A Jury Facilities Objectives	6.2
1.B Accessibility.....	1.3	6.B Jury Assembly Spaces.....	6.2
1.C Design Principles	1.4	6.C Objectives of the Clerk’s Office	6.5
1.D Sustainable Design	1.6	6.D Clerk’s Office Spaces	6.5
2 COURTHOUSE ORGANIZATION		6.E Court Executive Officer’s Area.....	6.9
2.A Program Stacking and Zoning.....	2.2	7 SPECIAL SERVICES	
2.B Space Standards.....	2.5	7.A Objectives.....	7.2
2.C Area and Volume Definitions.....	2.6	7.B Family Law Facilitators and Services for Self-Represented Litigants	7.2
2.D Occupancy and Exiting Calculations	2.9	7.C Family Court Services.....	7.4
2.E Court Floor Plan for Occupancy and Exiting Analysis	2.11	7.D Child Waiting Room (Optional).....	7.6
3 SITE DESIGN		7.E Alternative Dispute Resolution.....	7.7
3.A Objectives.....	3.2	7.F Multipurpose Rooms and Offices.....	7.7
3.B Parking	3.2	7.G Lactation Rooms	7.8
3.C Site and Building Security	3.5	8 IN-CUSTODY DEFENDANT RECEIVING, HOLDING, AND TRANSPORT	
3.D Integration of Building and Site	3.5	8.A Objectives.....	8.2
4 COURTHOUSE SECURITY		8.B Planning Criteria	8.2
4.A Objectives	4.2	8.C Functional Overview.....	8.3
4.B Design, Technology, and Operations.....	4.2	8.D Program Components	8.5
4.C Factors Affecting Security Levels.....	4.3	8.E Technical Criteria.....	8.13
4.D Risk Assessment Procedures	4.4	8.F Electronic Detention Control System	8.25
4.E Physical Security Planning Criteria.....	4.4	9 PUBLIC SPACES	
4.F Structural Systems	4.13	9.A Objectives.....	9.2
4.G Mechanical, Electrical, and Fire Protection Systems	4.15	9.B Primary Building Entrance.....	9.2
4.H Electronic Security Planning Criteria	4.16	9.C Public Lobby.....	9.2
4.I Electronic Security Systems	4.20	9.D Courtroom Public Waiting Areas.....	9.5
4.J Bullet-Resistant Glazing and Panels.....	4.22	10 BUILDING SUPPORT SERVICES	
5 COURT SET		10.A Janitor Closets.....	10.2
5.A Objectives	5.2	10.B Loading Dock	10.2
5.B Courtroom	5.3	10.C News Media Functions	10.3
5.C Courtroom Accessibility	5.5	10.D Mailroom.....	10.3
5.D Courtroom Components.....	5.6	10.E Maintenance Shops and Office	10.3
5.E Courtroom Support Spaces	5.15	10.F Storage	10.3
		10.G Mechanical Equipment Enclosures	10.4
		10.H Fire Alarm and Emergency Communication System Control Room.....	10.4

DIVISION TWO: TECHNICAL CRITERIA

	PAGE		PAGE
11 ARCHITECTURAL CRITERIA		16 LIGHTING CRITERIA	
11.A Objectives.....	11.2	16.A Objectives.....	16.2
11.B Architectural Criteria	11.2	16.B Lighting Criteria	16.2
11.C Building Elements: Exterior Construction	11.2	16.C Lighting Strategies.....	16.6
11.D Building Elements: Interior Construction.....	11.9	16.D Lighting Controls	16.9
11.E Signage	11.17	16.E Lighting Commissioning	16.11
12 STRUCTURAL CRITERIA		17 NETWORK AND COMMUNICATION SYSTEMS	
12.A Objectives	12.2	17.A General Overview	17.2
12.B Structural Systems	12.2	17.B Minimum Point of Entry (MPOE).....	17.4
12.C Criteria for Service Loads	12.2	17.C Distribution Pathways	17.11
12.D Criteria for Rare Loads	12.4	17.D Backbone Connectivity	17.14
12.E Life Cycle Cost Analysis	12.6	17.E Horizontal Connectivity	17.15
12.F Quality Assurance	12.7	17.F Administration and Verification	17.19
12.G Fire-Resistive Ratings of Structural Elements.....	12.7	17.G Network Architecture	17.20
13 MECHANICAL CRITERIA		17.H Distributed Antenna System	17.24
13.A Objectives.....	13.2	18 AUDIOVISUAL SYSTEMS	
13.B HVAC Criteria	13.3	18.A Audiovisual Design.....	18.2
13.C Humidification and Water Treatment.....	13.11	18.B Audiovisual Criteria	18.2
13.D Mechanical Requirements for Specific Spaces.....	13.11	18.C Technical Infrastructure	18.3
13.E Plumbing and Piping Systems Criteria.....	13.13	18.D Audiovisual Systems Descriptions	18.3
13.F Insulation	13.17	18.E Description of Courthouse Spaces	18.9
13.G Thermometers and Gauges	13.18	19 ACOUSTICAL CRITERIA	
14 BUILDING MANAGEMENT SYSTEM CRITERIA		19.A Objectives.....	19.2
14.A Objectives.....	14.2	19.B Acoustical Criteria	19.2
14.B Building Management System	14.2	19.C Best Practices	19.8
14.C Level of Integration.....	14.4	20 FIRE PROTECTION CRITERIA	
14.D Energy Conservation Design	14.4	20.A Objectives.....	20.2
14.E Design Features	14.6	20.B Fire Protection Criteria	20.2
14.F Commissioning.....	14.6	20.C Fire Alarm System Objectives.....	20.8
15 ELECTRICAL CRITERIA		20.D Fire Alarm System Criteria	20.9
15.A Objectives.....	15.2		
15.B Electrical Criteria	15.2		
15.C Emergency and Standby Power Systems	15.9		

REQUIRED TOOLS

TOOL 1: LIFE CYCLE COST ANALYSIS	PAGE
T1.A Purpose	T1.2
T1.B Principles	T1.3
T1.C Performing LCCA	T1.11

TOOL 2: CATALOG OF COURTROOM LAYOUTS FOR CALIFORNIA TRIAL COURTS

T2.A Courtroom Layout Overview	T2.2
T2.B Multipurpose Courtroom Templates	T2.4
T2.C Courtroom Design Examples	T2.29
T2.D Holding Core Templates	T2.45

TOOL 3: INTEGRATED NETWORK ARCHITECTURE

TOOL 4: GRAPHICAL USER INTERFACE TEMPLATE

T4.A Introduction	T4.2
T4.B Page Descriptions	T4.2

TOOL 5: IN-CUSTODY INTERVIEW ROOM GUIDELINES

T5.A Acoustic Study	T5.2
T5.B Observations and Measurement Results ..	T5.3
T5.C Requirements	T5.3
T5.D Speech Privacy	T5.5
T5.E Sound Isolation	T5.5
T5.F As-Built Dimensioned Drawing	T5.6
T5.G Selective Performance Requirements for Interview Rooms Specification	T5.6

TOOL 6: BUILDING MANAGEMENT SYSTEM GUIDELINES

T6.A General Requirements	T6.2
T6.B General Pneumatic Control Requirements	T6.5
T6.C General Design Requirements	T6.6
T6.D System Requirements	T6.8

APPENDIXES

APPENDIX 1: CODES AND STANDARDS

APPENDIX 2: LIST OF ABBREVIATIONS

APPENDIX 3: INDEX

APPENDIX 4: ACKNOWLEDGMENTS

The Judicial Council of California has full responsibility, jurisdiction, control, and authority over trial court facilities, and shall adopt appropriate facilities standards under Government Code section 70391. The Judicial Council is served by its staff administrative organization, of which the Facilities Services office has the responsibility under Government Code section 70391 and rules 10.180 and 10.181 of the California Rules of Court to prepare and present to the Judicial Council recommendations for policies, procedures, and standards for ensuring that the courts have adequate and sufficient facilities.

With the transfer of responsibility for design, construction, and management of court facilities from counties to the state, the Judicial Council has determined that it is prudent to develop standards reflecting the best practices and successful solutions for basic components of the trial court building. On adoption by the Judicial Council of the standards in *California Trial Court Facilities Standards* (hereafter the *Facilities Standards*), Facilities Services staff, in accordance with rule 10.180 of the California Rules of Court, will apply the standards for design and construction of court facilities.

This edition supersedes the *Facilities Standards* adopted by the Judicial Council effective April 2006, the amendment to the 2006 *Facilities Standards* effective March 2010, the 2011 draft update to the *Facilities Standards* (not officially adopted), and the 2020 edition effective November 2020.

This 2023 edition is an expansion of the earlier *Facilities Standards*; it has been developed using input from a variety of sources, including comments from knowledgeable judges, court administrators, court facility planners, and facility operations technicians; insight from experienced architects, engineers, and building code officials; and reference sources such as federal and other state court facility standards. Lessons learned from the design and construction of recent court buildings in California, using the 2011 and 2020 editions, have been identified and incorporated in this 2023 edition.

This *Facilities Standards* edition shall be utilized with professional care as stated in the service agreements between the Judicial Council and consultants retained for specific projects, and shall be used in conjunction with applicable code and project requirements as the basis of design for new court facilities in California. For each court construction or major renovation project, the Judicial Council staff and the affected court will establish an advisory group in accordance with rule 10.184(d) of the California Rules of Court; the advisory group will assist the Judicial Council staff with implementing the facilities standards for that specific project.

The *Facilities Standards* will promote buildings that are functional, durable, maintainable, and efficient and that provide long-term value to the public, the judicial branch, courthouse occupants, the community in which they reside, and court users and taxpayers of California. This *Facilities Standards* edition attempts to maximize value to the State of California by balancing the aesthetic, functional, and security requirements of courthouse design with the budget realities of initial construction costs and the long-term life cycle costs of owning and operating institutional buildings.

Judicial Council of California
Facilities Services

DRAFT

DIVISION ONE: DESIGN CRITERIA

- 1 General Principles
- 2 Courthouse Organization
- 3 Site Design
- 4 Courthouse Security
- 5 Court Set
- 6 Jury Facilities and Court Administration
- 7 Special Services
- 8 In-Custody Defendant Receiving, Holding,
and Transport
- 9 Public Spaces
- 10 Building Support Services

DRAFT

DIVISION ONE: DESIGN CRITERIA

1

GENERAL PRINCIPLES

SECTION	TOPIC	PAGE
1.A	Functional Usefulness, Physical Durability, and Maintainability	1.2
1.B	Accessibility	1.3
1.C	Design Principles	1.4
1.D	Sustainable Design	1.6

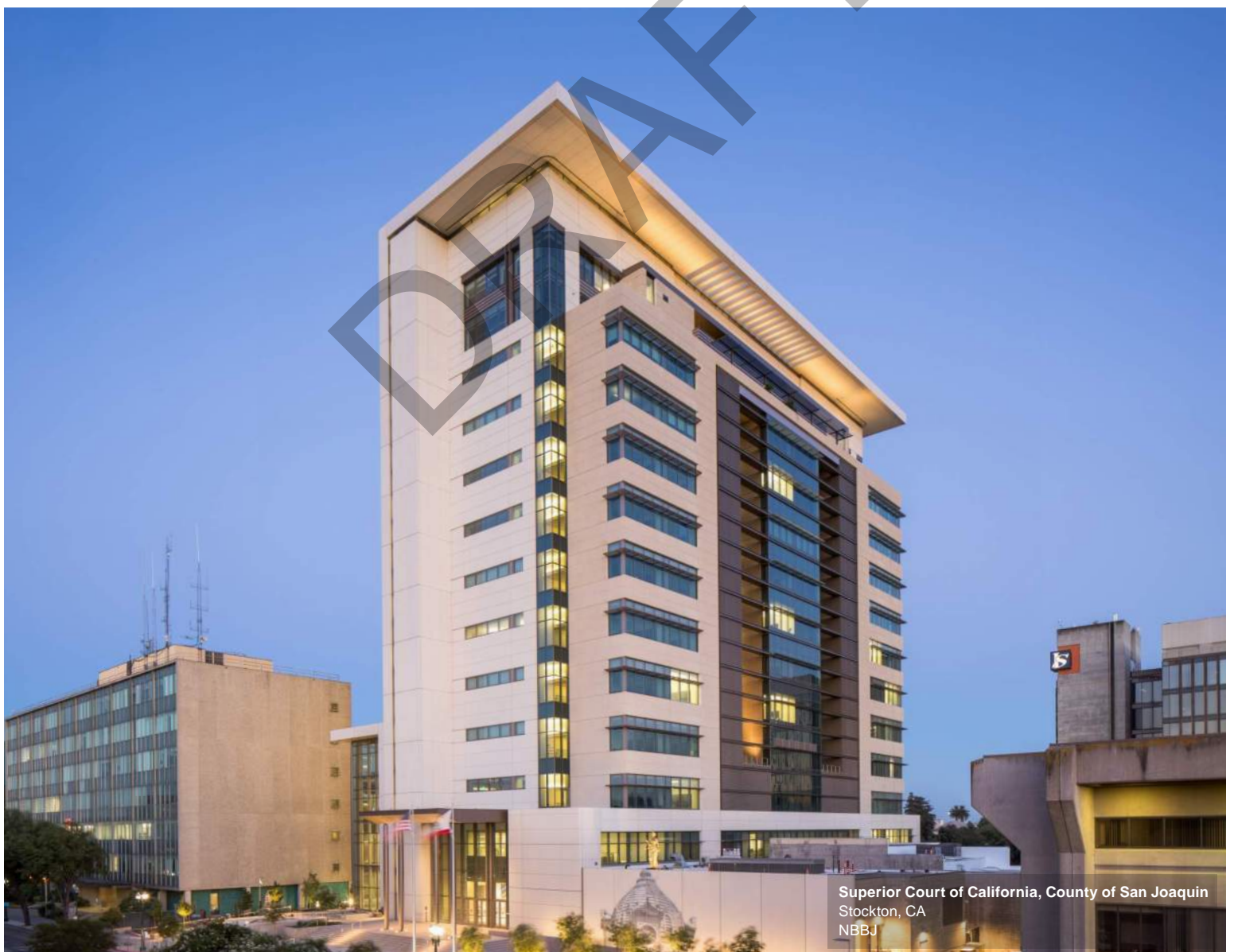

Superior Court of California, County of San Joaquin
Stockton, CA
NBBJ

Important References

California Green Building Standards Code (CALGreen), California Code of Regulations, title 24, part 11 (current version)

Facilities Standards for the Public Buildings Service (U.S. General Services Administration)

California Energy Design Assistance Program (CEDA), an energy-efficiency program

American Society of Heating, Refrigerating and Air-Conditioning Engineers (ASHRAE), an international organization for advancing heating, ventilation, air-conditioning, and refrigeration

LEED (Leadership in Energy and Environmental Design), a registered trademark of the U.S. Green Building Council and a voluntary program in which buildings obtain Silver, Gold, or Platinum certification based on the number of points achieved through the LEED rating system, where each level represents a more sustainable building

The most recent version of applicable code requirements, which shall be used during design (for more information, see the appendix Codes and Standards)

“Universal Design is the design of products and environments to be usable by all people, to the greatest extent possible, without the need for adaptation or specialized design.”

Ronald L. Mace, FAIA
(1941–1998)

California Trial Court Facilities Standards defines the minimum space and the functional, technical, and security requirements for the design of new court facilities in the state of California. The *Facilities Standards* reflects best practices and successful solutions as the basis for design and construction of functional, durable, maintainable, efficient, and secure contemporary court facilities.

The *Facilities Standards* provides the criteria to be used by designers, the judiciary, court administrators, and facility planners. It provides a resource of planning and technical criteria. The Basis of Design for new projects shall comply with the *Facilities Standards* while allowing flexibility for the designer to deliver the best value to the Judicial Council. In case of any discrepancy between the Basis of Design and *Facilities Standards*, the *Facilities Standards* shall govern the decision.

Each courthouse project entails many variables that influence design decisions, including size, calendar type, location, climate, geography, and site context. The *Facilities Standards* provides a basic understanding of the programmatic, design, and operational concerns common to court facilities, and it illustrates how standards may reasonably be applied to meet the needs of individual projects. The specific solutions may vary by project; therefore, the diagrams shown are representational and do not describe the only acceptable solutions. Variations have been indicated in some cases, but designers have flexibility to propose solutions that are appropriate to specific project requirements.

The facilities standards in this document represent minimum planning and design expectations; these facilities standards do not exempt designers from meeting the standard of care for their profession.

This document is intended primarily for new court building projects. However, many of the design criteria and performance standards may be applicable to substantial court renovation projects or building system upgrades in existing court buildings, buildings shared with other related justice agencies, leased facilities, and tenant improvements. For projects subject to the *Facilities Standards*, the most recent updated version of *Facilities Standards* at the time of creation of criteria documents or schematic design documents shall govern.

1.A FUNCTIONAL USEFULNESS, PHYSICAL DURABILITY, AND MAINTAINABILITY

1. Design Team Guidelines

California court facilities shall be functional, durable, and easy to maintain. The design team shall:

- Select value-driven solutions benefiting the Judicial Council and the taxpayers for the entire life cycle of the building.
- Define a clear approach to space planning, space use, and the integration of building systems to positively impact occupants and maximize efficiency.
- Provide easily accessible, operable, and maintainable building systems, products, and materials.
- Provide long-term value by balancing initial construction costs with projected life cycle operational costs.

To achieve value and limit total ownership costs, architects, engineers, and designers shall develop building components and assemblies that function effectively for the durations (target functional lifetimes) outlined in tool 1, Life Cycle Cost Analysis.

2. Life Cycle Cost Analysis

Selection of major building components, materials, and systems must consider long-term costs for operations and maintenance. Life cycle cost analysis (LCCA) shall be used to evaluate the total cost of ownership for design alternatives over the useful life of components or systems in a court facility. The Judicial Council will consider life cycle cost analysis, along with other project-specific factors, in determining acceptability of design alternatives.

- a. Whole-building life cycle assessment should be conducted, including operating energy, showing that the building project achieves the code-required percentage improvement for at least four impacts—including climate change, stratospheric ozone depletion, photochemical oxidants (smog), and water conservation—when compared to a reference building of similar size, function, complexity, and operating energy performance, and that it meets current California Energy Code requirements, at a minimum.
- b. Life cycle assessments shall be compliant with International Organization for Standardization’s ISO 14044.
- c. LCCA shall be applied over a 30-year life cycle for design alternatives. The target functional lifetimes for components and systems are outlined in required tool 1, Life Cycle Cost Analysis.
- d. LCCA shall be prepared using the building LCCA program available from the Federal Energy Management Program (FEMP) or similar tools accepted by the Judicial Council, or the LCCA tool provided for use by the council.
- e. Energy consumption costs shall be calculated from annual energy usage reports generated by compliance software and relevant utility time-of-use rate schedules for the local energy utilities.
- f. The discount, inflation, and escalation rates shall be determined as described in the Judicial Council LCCA procedure.
- g. Unless otherwise directed, a 5 percent real discount rate shall be used for all studies.
- h. Selection of structural systems, building components, and materials should consider long-term capital cost impacts of estimated losses resulting from expected earthquakes and other rare and damaging events.
- i. In certain projects, to be determined by the Judicial Council, the LCCA should be based on known and established methods and techniques, including simulations, to estimate probable losses—resulting from seismic events—at various confidence levels for individual event scenarios or over a considered time frame. In complicated scenarios, a formal risk analysis should be undertaken.
- j. Table 1.1 lists the building components, materials, or systems that may be subject to LCCA, depending on the size or scale of a particular court facility.

1.B ACCESSIBILITY

Accessibility is an integral component of civic building planning and design. As an essential element of the justice system, courthouses must be easily accessible to the public. Because of the unique spaces and functions, court buildings often present unique access challenges for persons with disabilities or with limited English language proficiency.

DIVISION ONE: DESIGN CRITERIA

- 1 GENERAL PRINCIPLES
 - 1.A Functional Usefulness, Physical Durability, and Maintainability
 - 1.B Accessibility
 - 1.C Design Principles
 - 1.D Sustainable Design
- 2 Courthouse Organization
- 3 Site Design
- 4 Courthouse Security
- 5 Court Set
- 6 Jury Facilities and Court Administration
- 7 Special Services
- 8 In-Custody Defendant Receiving, Holding, and Transport
- 9 Public Spaces
- 10 Building Support Services

Universal Key Goals

- Comply with sustainable initiatives.
- Plan and design for flexibility.
- Use natural strategies.
- Improve energy efficiency.
- Perform building commissioning.
- Promote healthy environments.

California court facilities shall be designed to provide long-term value by balancing initial construction costs with projected life cycle operational costs.

LCCA = life cycle cost analysis

FEMP = Federal Energy Management Program

1. Universal Design

Because most people experience changing physical abilities over a lifetime and benefit from barrier-free design, the design team shall use the principles of Universal Design with the goal of providing equal access to court facilities and making the built environment usable by as many people as possible, regardless of age, ability, or condition. The principles of Universal Design are:

- *Equitable Use:* The design is useful and marketable to people with diverse abilities.
- *Flexibility in Use:* The design accommodates a wide range of individual preferences and abilities.
- *Simple and Intuitive Use:* Use of the design is easy to understand, regardless of the user's experience, knowledge, language skills, or current concentration level.
- *Perceptible Information:* The design communicates necessary information effectively to the user, regardless of ambient conditions or the user's sensory abilities.
- *Tolerance for Error:* The design minimizes hazards and the adverse consequences of accidental or unintended actions.
- *Low Physical Effort:* The design can be used efficiently and comfortably and with a minimum of fatigue.
- *Size and Space for Approach and Use:* Appropriate size and space are provided for approach, reach, manipulation, and use, regardless of the user's body size, posture, or mobility.

(The Center for Universal Design, The Principles of Universal Design (Raleigh, N.C.: North Carolina State University, 1997).)

2. Application

Universal Design principles shall be incorporated into all court buildings.

Courthouses shall be designed in accordance with California Building Code chapter 11B, which sets the baseline standards of equal facilitation for public buildings, in addition to applicable federal regulations. Compliance with chapter 11B incorporates the Americans with Disabilities Act of 1990 (ADA) guidelines.

1.C DESIGN PRINCIPLES**1. Building Orientation and Wayfinding**

Many court facility users, especially first-time visitors and people with hearing or visual impairment, are unfamiliar with the public functions and spaces in the courthouse and require assistance in determining where they need to go. Clear circulation, wayfinding visual cues, signage, and graphics are important design elements that will minimize confusion and enhance the visitor's experience when using the courts.

Architects shall provide clear and identifiable pedestrian paths of travel to the main entrance of the courthouse and through internal corridor and site circulation systems, enabling the public to easily understand the facility's organization. They shall provide a coordinated series of visual cues, placed in strategic locations, to allow visual orientation to key functional public areas, including courtrooms, the clerk's office, self-help centers, and the jury assembly room.

Views to the outdoors and of architectural elements, windows, doors, landscaping, color,

texture, and scale are among the design opportunities that can be applied when developing a wayfinding program. Other visual strategies that enhance orientation include stylized door types, door surrounds, and interior glazing, in addition to standardized, multilingual signage. These elements encourage building users to rely on intuitive decisions, rather than signage only, when navigating the building. Other wayfinding strategies include:

- Locating the entries of high-volume public-use spaces so that they can be seen directly from the public entry lobby, or if locations of high-volume spaces cannot be seen from the lobby, providing visual clues immediately on entering the building;
- Providing weapons screening that is integral to the design of the lobby, including path-of-travel and queuing considerations;
- Providing vertical circulation (public stairs and/or elevators) directly adjacent to, or clearly visible from, the public lobby;
- Providing clear, concise, and attractive graphics, signage, and visual elements so that visitors can locate their destinations without asking security personnel or courthouse staff for assistance; and
- Planning and locating public toilet rooms, waiting areas, courtrooms, and public areas in the same areas on each floor to enhance orientation.

2. Small, Medium, and Large Courthouses

The *Facilities Standards* provides guidance about appropriate systems or components for small (1 to 6 courtrooms), medium (7 to 19), or large (more than 19) court buildings. Design responses to programmatic needs will vary, depending on the court facility size, type, and location.

For example, a small rural courthouse requires a different architectural scale, exterior cladding, room size, and building system than those required for a large urban courthouse. Design solutions should be consistent and appropriate for the court type, size, location, context, project complexity, and community the court serves.

3. Flexibility and Growth

California court facility space needs change over time.

- a. Court facilities shall be planned for flexibility and, to the extent feasible, to accommodate growth without increasing the authorized gross square footage. Examples of programmed flexibility include standard courtroom sizes with capacity for juries or special case types, and standard structural modules with adequate dimension and capacity to be converted to courtroom space.
- b. Floor-to-floor heights, location of vertical and horizontal circulation elements, and column bay dimensions shall allow for conversion of office space into courtrooms. This approach will permit expansion of the judiciary within buildings containing infrastructure elements such as central holding, secure elevators, and electronic security systems.
- c. Building infrastructure and raceway shall allow for a reasonable amount of future expansion consistent with the project program and funding.

DIVISION ONE: DESIGN CRITERIA

- | | |
|-----|---|
| 1 | GENERAL PRINCIPLES |
| 1.A | Functional Usefulness, Physical Durability, and Maintainability |
| 1.B | Accessibility |
| 1.C | Design Principles |
| 1.D | Sustainable Design |
| 2 | Courthouse Organization |
| 3 | Site Design |
| 4 | Courthouse Security |
| 5 | Court Set |
| 6 | Jury Facilities and Court Administration |
| 7 | Special Services |
| 8 | In-Custody Defendant Receiving, Holding, and Transport |
| 9 | Public Spaces |
| 10 | Building Support Services |

4. Design Excellence

The *Facilities Standards* requires implementation of design excellence principles outlined by the Judicial Council organization's Facilities Services office in its *Project Procedure DB A-11: Quality Management Plan*. To promote accountability and consistency and to focus on results for all projects, Facilities Services developed success factors that are measurable: scope, budget, schedule, quality, customer satisfaction, and team satisfaction.

The success factors are measured based on the quality of the court building that is being designed and constructed, because the building transcends the completion of the project.

Following are the elements that are evaluated in measuring quality and finalizing a quality score during each stage of design:

1. Reflection of the dignity of the law and the stability of the judicial system.
2. Responsiveness to local context, geography, climate, and setting.
3. Reflection of the importance of the activities within the courthouse, with adequate spaces that are planned and designed to be adaptable to change.
4. Consideration of the economics of operation and maintenance, including controlling long-term ownership costs.
5. A sustainable, healthy, safe, and accessible environment.
6. Technical excellence in building systems.

1.D SUSTAINABLE DESIGN

The objectives, design criteria, and performance goals outlined below provide the basis for the planning and design of sustainable trial court buildings in California.

1. Objectives

- a. Architects and engineers shall focus on proven design approaches and building elements that improve court facilities for building occupants and result in cost-effective, sustainable buildings.
- b. All new courthouse projects shall be designed and constructed in conformance with the Nonresidential Mandatory Measures of the current version of the California Green Building Standards Code (CALGreen) (Cal. Code Regs., tit. 24, pt. 11), as well as the current version of the California Energy Code (Cal. Code Regs., tit. 24, pt. 6). All projects shall target 15 percent increased energy efficiency and 12 percent increased water conservation levels as compared to the minimum requirements of Title 24.
- c. Implementation of CALGreen Tier 1 Nonresidential Voluntary Measures will depend on a positive net present value result of the Tier 1 LCCA design options or Judicial Council LCCA procedure-based design against a code-compliant design.
- d. Additionally, all new courthouse projects shall be designed to receive the Leadership in Energy and Environmental Design (LEED) Silver rating or higher without an increase in the authorized project budget or long-term operating costs.

2. Design Criteria and Performance Goals

2.1 Compliance Requirements and Goals

The following design criteria and performance goals are universally applicable to all court buildings and shall provide a direct benefit to building occupants and reduce ownership costs.

- a. Comply with the current version of the CALGreen Nonresidential Mandatory Measures as described above.
- b. Comply with the current version of the California Energy Code (Cal. Code Regs., tit. 24, pt. 6).
- c. Comply with the current LEED criteria as described above.
- d. Plan and design for flexibility to anticipate future changes and enhance building longevity. Use modular planning and flexible building infrastructure for HVAC (heating, ventilation, and air-conditioning), power, security, and communication systems.
- e. Conserve water. Install building-level water submeters to allow for the management of water use during occupancy, including the detection of leaks. Use low-flow plumbing fixtures that meet current California regulations, install water-efficient appliances, eliminate any designs with single-pass cooling, and optimize cooling tower operations through the use of pH conductivity controllers for minimizing cooling tower blowdown. Where feasible, request a connection to the local water utility nonpotable (purple pipe) water main for use in irrigation and evaporative cooling systems. Use energy-efficient HVAC equipment. Meet the applicable statewide and regional requirements of State Water Resources Control Board.
- f. Use natural strategies to protect and restore water resources. Limit disruption to existing vegetated areas. To purify runoff and promote groundwater recharge, use natural stormwater treatment systems such as bioretention, bioswales, and permeable paving, as geographically appropriate.
- g. Improve energy efficiency and provide thermal comfort. Optimize the building envelope and develop passive solar strategies. Design energy-efficient HVAC systems and use high-efficiency pumps and motors. In addition to complying with CALGreen, use whole-building energy model analysis to refine the design so that whole-building energy consumption is permissible for ASHRAE 90.1-compliant court buildings. Whole-building energy models must be optimized to comply with the location-specific California Building Climate Zone. Perform building commissioning to verify that systems perform as designed and modeled. Building commissioning is required per the current Building Energy Efficiency Standards section 120.8, Nonresidential Building Commissioning, and current CALGreen chapter 5 criteria, and LEED criteria as described above.
- h. Promote occupant health and well-being in the indoor environment. Provide a connection to natural daylight, optimal lighting and acoustics, and good indoor air quality. Coordinate daylighting with high-efficiency electric lighting and programmable controls. Develop systems and detailing that maintain thermal comfort and prevent microbial contamination.
- i. Evaluate and plan for occupant thermal comfort conditions based on future climatic conditions for the project location using Cal-Adapt or an equivalent climate change scenario tool for the facility’s lifetime.
- j. Create construction Indoor Air Quality (IAQ) management plan, perform building flush-out, and conduct IAQ testing as outlined in the requirements for LEED EQ Credit: Construction Indoor Air Quality Management Plan and EQ Credit: Indoor Air Quality Assessment.

**DIVISION ONE:
DESIGN CRITERIA**

1	GENERAL PRINCIPLES
1.A	Functional Usefulness, Physical Durability, and Maintainability
1.B	Accessibility
1.C	Design Principles
1.D	Sustainable Design
2	Courthouse Organization
3	Site Design
4	Courthouse Security
5	Court Set
6	Jury Facilities and Court Administration
7	Special Services
8	In-Custody Defendant Receiving, Holding, and Transport
9	Public Spaces
10	Building Support Services

- k. Specify materials that are accompanied by Environmental Product Declarations (EPDs). Use locally sourced materials when possible. Do not specify or install building materials included in the International Living Future Institute's Living Building Challenge Red List.
- l. Plan for recycling of materials during construction, demolition, and occupancy. Develop specifications for construction recycling; require contractors to develop a construction waste management plan that identifies waste minimization and recycling strategies. The construction project shall, at minimum, meet the mandatory waste diversion rates specified in CALGreen at the time of project permitting.
- m. Provide collection bins for public refuse and recyclable and organic materials on each floor, as well as a staging area for materials collection.

2.2 Best Practices

The following design criteria and performance goals shall be applied as best practices:

- a. Use sustainable building materials. Evaluate the life cycle environmental impacts such as embodied carbon, resource efficiency, and performance of building materials. Seek out nontoxic low- or no-VOC (volatile organic compound) materials from local, renewable, and sustainably acquired resources that minimize waste and pollution from manufacturing, installation, and maintenance. Do not use tropical hardwoods. Do not use materials with hazardous components such as asbestos, lead, and PCBs.
- b. Use native and climate-appropriate drought-tolerant plants and trees. Reduce maintenance and irrigation requirements by using native plant species. Explore opportunities to provide habitat for wildlife, including protection and promotion of pollinator habitat, and to restore degraded site areas. Turf is not permitted.
- c. Seek opportunities to redevelop existing sites. Develop links to public transit, and create strategies for pedestrian-friendly, mixed-use communities.
- d. Install HVAC, refrigeration, and fire suppression equipment that does not contain the ozone-depleting gases regulated by the Montreal Protocol, specifically chlorofluorocarbons (CFCs) or halons. Specify low global warming potential refrigerants for use in HVAC, refrigeration, and fire suppression systems, as defined in the Regulation for the Management of High Global Warming Potential Refrigerants for Stationary Sources, California Air Resources Board: (1) any refrigerant with a global warming potential value lower than 150, or (2) any refrigerant that is not an ozone-depleting substance (Cal. Code Regs., tit. 17, § 95382). For systems containing fluorinated greenhouse gases equivalent to more than 500 metric tons of CO₂, the design should incorporate an automatic leak-detection system. The leak-detection system must alert building maintenance staff, or a service company responsible for maintaining the relevant equipment, if a leak is detected.

3. Participation in Energy Savings Programs

The Judicial Council recommends participation in new-construction incentive programs sponsored by investor-owned utilities or other programs that are or may become available. Participation is encouraged to promote energy efficiency and environmental awareness, and

as a guide for sound energy usage and cost decisions. Programs such as CEDA address energy efficiency in new construction and renovation projects and are funded by utility customers through the public purpose program surcharge applied to gas and electric services. Some services offered under programs such as these include design assistance, energy-efficiency analysis, life cycle cost analysis, and financial incentives for the facility owner and design team.

- a. As long as CEDA or equivalent applicable programs are funded by the local utility, California Public Utility Commission, or California Energy Commission for participation, all new California court projects shall participate in the program and evaluate energy-efficiency measures.
- b. For CEDA and other energy savings programs, a court project must analyze energy-efficiency measures using the “whole building approach” and life cycle cost analysis to determine the financial feasibility of incorporating these measures into a court building.

Table 1.1 Typical Components to Be Considered in a Life Cycle Cost Analysis

COMPONENT	TYPICAL ALTERNATIVES TO BE ANALYZED
Predesign	
	Impacts of new acquisition, leasing and/or public-private partnerships
	Renovation, upgrade, or revitalization of an existing facility
	Use of other state facilities
General Life Cycle Cost Issues for All Components	
	Element/component service and replacement life
	Maintenance and maintainability
	Direct and indirect energy impacts
Site and Program	
	Building shape and orientation on the planned site (including impact on adjacent buildings)
	Alternative site(s)
	Seismic, environmental, and community issues
Architecture	
Substructure	
	Foundations—Water infiltration, special seismic features
	Slab on grade—Special loads, vibration isolation
	Basement excavation—Use of import/export materials
	Basement and retaining walls—Water infiltration
Superstructure	
	Floor construction—Seismic impacts, floor displacement, noise isolation, security
	Roof construction—Seismic impacts
	Stair construction—Long-term maintainability, safety

Table 1.1 continues on next page

**DIVISION ONE:
DESIGN CRITERIA**

- 1 GENERAL PRINCIPLES**
 - 1.A Functional Usefulness, Physical Durability, and Maintainability
 - 1.B Accessibility
 - 1.C Design Principles
 - 1.D Sustainable Design
- 2 Courthouse Organization
- 3 Site Design
- 4 Courthouse Security
- 5 Court Set
- 6 Jury Facilities and Court Administration
- 7 Special Services
- 8 In-Custody Defendant Receiving, Holding, and Transport
- 9 Public Spaces
- 10 Building Support Services

Table 1.1 Typical Components to Be Considered in a Life Cycle Cost Analysis *continued*

COMPONENT	TYPICAL ALTERNATIVES TO BE ANALYZED
Architecture (continued)	
Wall construction	
	Increased insulation levels, insulation placement, etc.
	Wall R-value
	Wall façade material
	Mass (passive solar thermal storage)
	Building Airtightness Value scfm/ft ²
	Daylighting
	Building envelope (exterior enclosure) type
Fenestration	
	Type, amount, and location/orientation of glass
	Window assemblies U-Factor
	Window Solar Heat Gain Coefficient (SHGC)
	Indoor/outdoor shading devices
	Daylighting
Interior space plan	
	Space arrangement and circulation
	Demising walls and partitions
	Finishes and colors
	Ceiling and plenum heights
Roof construction	
	Increased insulation levels, type of insulation
	Roof membrane type and color
	Roof R-value
	Daylighting
Conveyances	
	Selection of elevators and dumbwaiters
	Escalators
Secondary HVAC systems	
	System types and zoning
	Operating plans, economizer cycle(s) and optimization
	Heat recovery (exhaust air, internal source, etc.)
	Controls
Primary HVAC systems	
	System types and energy sources
	Pumping/piping configuration
	Heat recovery (waterside economizer cycle, etc.)
	Thermal storage (electrical demand shifting)
	Controls

Table 1.1 continues on next page

Table 1.1 Typical Components to Be Considered in a Life Cycle Cost Analysis *continued*

COMPONENT	TYPICAL ALTERNATIVES TO BE ANALYZED
Plumbing	
	Domestic hot water generation (method and energy source)
	Water source—Municipal, well, or harvested
Electrical	
Lighting and communications	
	System selection
	Artificial lighting levels, methods, and control
	Daylighting
	Photovoltaic sources
	Communications and data management
Power	
	Voltage selection (building and large equipment)
	Transformers (quantity, locations, efficiencies)
	On-site renewable energy systems type and system rating
	Emergency power system type and fuel source (diesel generator and battery energy storage system base options)

**DIVISION ONE:
DESIGN CRITERIA**

- 1 GENERAL PRINCIPLES**
 - 1.A Functional Usefulness, Physical Durability, and Maintainability
 - 1.B Accessibility
 - 1.C Design Principles
 - 1.D Sustainable Design
- 2 Courthouse Organization
- 3 Site Design
- 4 Courthouse Security
- 5 Court Set
- 6 Jury Facilities and Court Administration
- 7 Special Services
- 8 In-Custody Defendant Receiving, Holding, and Transport
- 9 Public Spaces
- 10 Building Support Services

DRAFT

DRAFT

DIVISION ONE: DESIGN CRITERIA

2

COURTHOUSE ORGANIZATION

SECTION	TOPIC	PAGE
2.A	Program Stacking and Zoning	2.2
2.B	Space Standards	2.5
2.C	Area and Volume Definitions	2.6
2.D	Occupancy and Exiting Calculations	2.9
2.E	Court Floor Plan for Occupancy and Exiting Analysis	2.11



Superior Court of California, County of San Benito
Hollister, CA
SmithGroup

The general organizational principles for courthouse functions are described in this chapter. Site and program constraints of each project will determine the optimum organization or configuration of a specific court facility.

Three Distinct Circulation Systems

- Public
- Detention
- Private

Any courthouse program must include adequate courtroom space to serve all the public needs that arise in the administration of justice. Courtrooms provide flexible, efficient and functional space which, to be sufficient, generally should be planned as one courtroom for every JPE (judicial position equivalent).

2.A PROGRAM STACKING AND ZONING

The courthouse program outlines the sizes and adjacencies required for courthouse organization. Courthouse organization is segregated both horizontally and vertically. The horizontal zoning and vertical stacking of spaces is determined based on the program and design review comments during the predesign phase. In courthouses with in-custody defendants, functionality and efficiency should be optimized by providing courtrooms in multiples of two, sharing one court floor holding area and a security elevator to the central in-custody defendant holding area. Courthouses require three separate and distinct zones of public, private, and detention circulation. Figure 2.1 indicates the vertical relationships of the three-part circulation system in a multilevel courthouse. The exact locations of these circulation systems may vary, depending on the location of departments and uses within the building.

1. Layout of Large Facilities

- High-volume public spaces and services should be conveniently accessible to the public entrances, minimizing elevator load and public penetration into the courthouse. They are typically located on the lower floors of court facilities, directly adjacent to the public lobby. These lower-floor functions typically include the clerks’ offices, jury services and the jury assembly room, child waiting rooms, records, a public cafeteria, self-help centers, alternative dispute resolution centers, and other frequently visited public areas, in addition to high-volume courtrooms (for arraignments, felony dispositions, and high-profile cases). Clerks’ offices shall be located on lower floors for functional efficiency and adjacency to public and semipublic functions.
- Consider providing exterior clerk/public transaction windows on the ground level to eliminate unnecessary public entry into the courthouse to pay traffic citations.
- If high-volume functions are located on the second floor, a connecting set of stairs—in addition to public elevators—shall be provided from the main public lobby to access these areas. Functions requiring less public contact or quieter surroundings—including courtrooms, court administration, and judges’ chambers—shall be located on the upper floors.

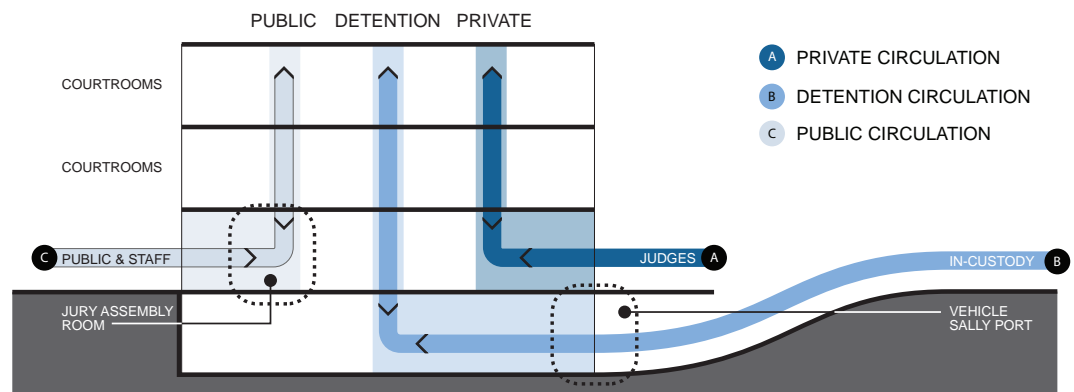

Figure 2.1 Cross-Section Showing Three-Part Circulation System

- d. Functions requiring higher levels of security and control—including law enforcement waiting, in-custody receiving and holding, and security command centers—should be located on or below the ground-level floors to minimize the transport of in-custody defendants within the courthouse and the security risk associated with this transport. Operational adjacencies shall be considered in the program stacking so that elevator travel times are as efficient as possible (i.e., arraignment courts typically include a steady flow of in-custody defendants, so they should be located on a lower floor closer to the central holding area).

2. Layout of Small Facilities

- a. High-volume public spaces and services are located directly adjacent to the public lobby; courtroom and high-security functions are located in more remote, quieter locations.
- b. Facilities that courts do not currently anticipate using as criminal courthouses may require only two dedicated circulation zones, public and private, because in-custody cases are not frequently processed in these facilities.
- c. Controlling unauthorized movement from a public zone to a private zone is a security requirement. Each circulation zone shall be separated from the others by access control systems or sally ports monitored from a central security operations center, and entry authorization protocols as part of security operations, as described in chapter 4, Courthouse Security. The three zones of horizontal and vertical circulation shall intersect only in controlled areas, including courtrooms, sally ports, and central holding. A brief description of the three circulation systems is illustrated in figure 2.2.
- d. For court facilities in which juvenile delinquency cases are adjudicated, the detention circulation for juveniles must be separated from adult detention circulation in a manner consistent with the requirements of state law. For additional requirements, refer to chapter 8, In-Custody Defendant Receiving, Holding, and Transport.

3. Public Circulation System

- a. The public circulation system provides access from the public point of entry to the controlled access points of the private and detention areas of the courthouse. A corridor circulation system should link the public lobby to all public parts of a court building. The overall building organization must be easily understood and be defined by this circulation system.
- b. Introduce natural light into public and restricted corridors where possible.
- c. Simplify building orientation and wayfinding to and from all public spaces and courtrooms.

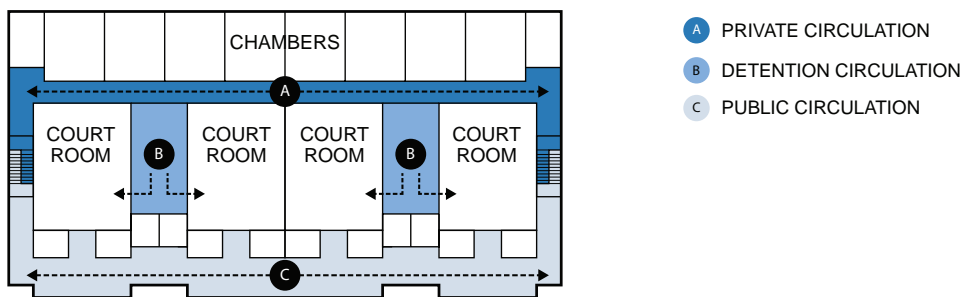

Figure 2.2 Three Circulation Zones

DIVISION ONE: DESIGN CRITERIA

- 1 General Principles
- 2 COURTHOUSE ORGANIZATION
 - 2.A Program Stacking and Zoning
 - 2.B Space Standards
 - 2.C Area and Volume Definitions
 - 2.D Occupancy and Exiting Calculations
 - 2.E Court Floor Plan for Occupancy and Existing Analysis
- 3 Site Design
- 4 Courthouse Security
- 5 Court Set
- 6 Jury Facilities and Court Administration
- 7 Special Services
- 8 In-Custody Defendant Receiving, Holding, and Transport
- 9 Public Spaces
- 10 Building Support Services

- d. Ensure that all areas that have a public service counter or require access by the general public are accessible from the public circulation system. These areas include the courtrooms, public counter areas, jury assembly room, mediation and alternative dispute resolution centers, self-help centers, administrative offices, public waiting areas, food service or vending areas, children’s waiting area, public restrooms, public elevators, and other public reception areas.
- e. All participants and visitors to the building shall pass through security screening at the main building entry. In buildings in which justice partners also occupy space in the courthouse building, their employees are to be screened but may have a separate passing lane with keycard access.
- f. The public circulation system also includes the public waiting areas immediately adjacent to courtrooms and attorney conference rooms. Appropriately size the public circulation corridors to allow for adequate waiting areas by providing benches or other breakout areas for conversation and waiting.
- g. The public circulation system may be located on the perimeter of the court floors, thereby providing windows that allow natural light in and promote a sense of the transparency of the judicial process to the outside public. This approach implies a single-loaded public corridor with courtrooms on one side of the corridor only, but some courthouses may benefit from a double-loaded corridor approach with courtrooms on both sides of the public corridor, thereby resulting in a more efficient component gross square footage ratio of circulation to program area.

4. Private Circulation System

The private circulation corridors provide access to court staff, judicial officers, escorted jurors, and security personnel. These corridors and vertical circulation systems connect courtrooms, chambers, support space, jury deliberation rooms, and authorized staff parking areas. Building service functions—including storage, staging and loading areas, security staff offices, and other support areas—are located within the private circulation zone.

- a. The private circulation system cannot be bisected by the public circulation system.
- b. In most courthouses, the emergency egress stair for private circulation should be separate from the egress stair for public circulation, but occasionally the public and private egress may be combined as long as security measures prohibit reentry to the floors. If dedicated egress stairs are provided for the private circulation system, intercommunicating connecting stairs may be used between staff areas on other floors. For the staff located closer to the egress stairs, the building’s required emergency egress stair system can be used as an intercommunicating stair between floors. Analyze the security, fire exiting, and smoke control system requirements before implementing this option.

5. Detention Circulation System

- a. The detention circulation system provides access between the secure in-custody entrance (sally port), central holding and intake areas, secure attorney-client interview rooms, courtroom holding areas, and courtrooms. The design of these areas shall prohibit unauthorized access by the public and escape by persons in custody.
- b. Separate the detention circulation system for in-custody defendants from the public and private circulation zones. Court holding facilities must have, for in-custody defendants, a secure path of travel that is separate from paths used by the public.

- c. Detention circulation corridors, elevators, and stairwells should minimize turns, alcoves, and other potential hiding places; detention circulation areas are monitored with video cameras supervised by the court security staff.
- d. Central holding, located in the basement or ground floor, shall have direct exiting to the outside per code requirements for I occupancy (California Building Code [CBC] Institutional occupancy classification for in-custody holding). Upper-floor detention circulation does not necessarily require its own independent means of emergency egress, assuming in-custody defendants are escorted and/or supervised during emergency exiting. Both the central holding and the holding core between courtrooms shall be constructed for I-3 occupancy with rated separation from other occupancy classifications. See tool 2, Catalog of Courtroom Layouts, for holding core templates.

2.B SPACE STANDARDS

1. Space Standards

The standards for the size of typical functional areas in California court facilities are listed in table 2.2. A selection of sample layouts is provided in figures 2.4–2.6.

2. Ceiling Heights

Table 2.1 lists the ceiling height requirements for functional areas of court facilities. All ceiling heights are measured to the face of ceiling finish. In courtrooms and public lobbies, heights will vary and may be lower or higher than the nominal height.

3. Corridor Widths

The following minimum and maximum corridor widths apply:

- Public corridors: 8'–12' clear, depending on code requirements for occupancy loading and amount of public waiting that is provided in the corridor.
- Private corridors: 6', depending on code requirements for occupancy loading.
- Detention corridors: Minimum 6'–8' in most areas where in-custody defendants are transported, and 8' in central holding areas where two detainees may be escorted in opposite directions, to minimize the risk of contact or conflict.

Table 2.1 Minimum Range for Ceiling Heights

SPACE	HEIGHT
Courtroom	12'–13'
Chambers	9'–10'
Public Lobby	15'–35'
Open Plan	9'–10'
Private Offices	9'–10'
Clerk's Public Spaces	9'–10'
Jury Assembly Room	10'–12'
Jury Deliberation Room	8'–10'
Public Corridors	9'–12'
Restricted Corridors	8'–9'
Ancillary Spaces	8'–10'
Secure Corridors	per BSCC stds.
Holding Cells	per BSCC stds.

BSCC = Board of State and Community Corrections.

DIVISION ONE: DESIGN CRITERIA

- 1 General Principles
- 2 COURTHOUSE ORGANIZATION
 - 2.A Program Stacking and Zoning
 - 2.B Space Standards
 - 2.C Area and Volume Definitions
 - 2.D Occupancy and Exiting Calculations
 - 2.E Court Floor Plan for Occupancy and Existing Analysis
- 3 Site Design
- 4 Courthouse Security
- 5 Court Set
- 6 Jury Facilities and Court Administration
- 7 Special Services
- 8 In-Custody Defendant Receiving, Holding, and Transport
- 9 Public Spaces
- 10 Building Support Services

Computation of CGSF

$$\text{CGSF} = \text{NSF} \times (1.15 \text{ to } 1.30)$$

$$\text{Exterior Gross Area} = \text{CGSF} \times (1.30 \text{ to } 1.40)$$

2.C AREA AND VOLUME DEFINITIONS

This section defines terms used in the planning and measurement of court building size and volume, and the ratios resulting from the implementation of these standards.

Any public spaces that extend above the first story shall be limited to 35' maximum height to the bottom of ceiling and shall not exceed 5 percent of the ground floor area, for buildings with fewer than 10 courtrooms, and 8 percent for buildings with 10 or more courtrooms.

1. Net Square Feet (NSF)

The amount of space required for or assignable to a specific employee classification or function, exclusive of interior walls or internal circulation, is the net area, expressed in net square feet. The *Facilities Standards* includes space standards that are described in NSF. For example, a courtroom of 1,650 NSF describes the courtroom floor area measured to the face of finishes, excluding the thickness of demising walls. However, space required for ramping outside the courtroom (e.g., ramps up to the judge's door in the private corridor) should also be included in the courtroom NSF; otherwise, the space required for the widened corridor to accommodate the ramp would have to be accounted for in the component gross square feet (see 2.C.2, Component Gross Square Feet (CGSF), below).

Functional areas to be included in the assignable NSF include but are not limited to court floor public waiting areas, weapons screening stations and the public queuing aisles serving them, server and telecommunications equipment rooms, courtroom technology closets, public entry lobby vestibules, courtroom vestibules, court floor holding, public waiting areas for all public service counters, self-help public access computer stations, elevator equipment rooms, mechanical and electrical equipment rooms, fire command center, security operations centers, enclosed parking spaces, vehicle sally ports, and enclosed receiving and recycling areas.

2. Component Gross Square Feet (CGSF)

The amount of area required by a department or component to function within a court facility is the component area, expressed in component gross square feet. In predesign, the CGSF is calculated by multiplying a department or component's total NSF by a factor, to approximate the area needed for circulation, partitions, and structural members and columns within the space. Circulation factors vary, depending on the type and size of the spaces in a component.

3. Exterior Gross Area

The gross area of California court buildings shall be measured in accordance with Building Owners and Managers Association's BOMA 2018 *Gross Areas: Standard Methods of Measurement*. Gross Area 1 (Leasing Method) shall be used to calculate Exterior Gross Area computed in accordance with the BOMA 2018 standards. Gross Area 4 (Construction Method) shall also be computed and provided for additional building analysis. These measurement methodologies are included within internal procedures to be used for designing and reports to the Judicial Council.

Courthouses require a relatively high grossing factor because of the multiple levels of circulation, assembly spaces, and public waiting areas. For predesign purposes, building gross square feet is typically 1.3 to 1.4 times the CGSF.

Figure 2.3 illustrates the relationships between NSF, CGSF, and Exterior Gross Area.

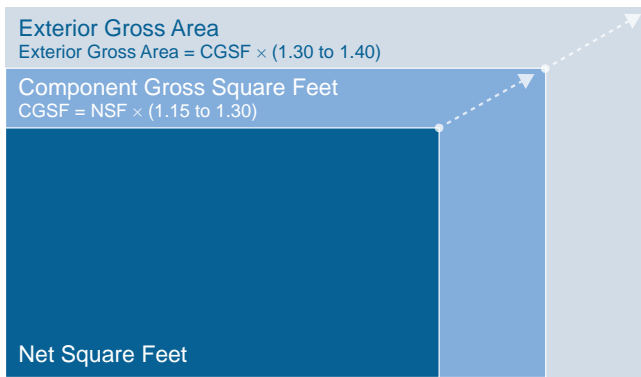

Figure 2.3 Courthouse Grossing Factors

4. Ratio of Total Building Area to Total Number of Courtrooms

- a. The application of the space standards and the planning factors should result in a range of 9,000 to 14,000 Exterior Gross Area per courtroom. During conceptual planning, a parametric modeling tool may be used to establish a typical Exterior Gross Area associated with a conceptual building program. This tool can identify the anticipated square footage for a facility based on facility characteristics such as jury assembly, central holding areas, and self-help centers. The basis range of 9,000 to 14,000 Exterior Gross Area for each courtroom can be further developed and refined through use of the parametric model.
- b. In general, courts that include a relatively large ratio of office departments to court sets, a unique program, or other specialized functions may have a larger-than-average Exterior Gross Area per courtroom. Conversely, court facilities that are used part time, have no in-custody holding capacity, or have no jury facilities may have less than the average Exterior Gross Area per courtroom. As the number of courtrooms increases, the overall efficiency (by this measure) of the building should increase and result in a total Exterior Gross Area that is lower than the average Exterior Gross Area per courtroom.
- c. For a one-courtroom courthouse project, annual case filings shall be considered and may warrant a reduction in the total size of the proposed new courthouse. The sizes of some functional areas should be reduced, and the development of multifunctional spaces should be maximized. For example, for a court handling a low annual caseload and number of jury trials, jury assembly could be held in a multipurpose room functioning as a conference room and jury deliberation room. Similarly, the jury seats in the courtroom may be used for seating in-custody defendants during arraignment. See section 2.C.7 for general guidance on the layout of a one-courtroom courthouse.

5. Relative Building Volume Ratios

The relative building volume ratio for California court facilities shall be in the range of 14 to 16 when total building gross area is divided by total interior building volume and expressed as a resultant. Court facilities typically require a higher volume ratio than office buildings to accommodate the higher ceilings of courtrooms and large assembly areas.

6. Predesign Planning Factors for Mechanical and Electrical Equipment Spaces

Mechanical and electrical equipment spaces are considered functional areas that are included in the assignable NSF.

DIVISION ONE: DESIGN CRITERIA

- 1 General Principles
- 2 COURTHOUSE ORGANIZATION
 - 2.A Program Stacking and Zoning
 - 2.B Space Standards
 - 2.C Area and Volume Definitions
 - 2.D Occupancy and Exiting Calculations
 - 2.E Court Floor Plan for Occupancy and Existing Analysis
- 3 Site Design
- 4 Courthouse Security
- 5 Court Set
- 6 Jury Facilities and Court Administration
- 7 Special Services
- 8 In-Custody Defendant Receiving, Holding, and Transport
- 9 Public Spaces
- 10 Building Support Services

- a. For planning purposes, mechanical spaces may be estimated to require 5 to 6 percent of the total estimated building gross. Mechanical rooms must provide adequate access for maintenance and repair.
- b. Electrical spaces will require an additional 2 to 3 percent of the total estimated building gross. Electrical rooms must provide code-required clearances around all equipment. Electrical rooms and data rooms must be stacked in multistory buildings.

7. Part-Time Satellite Court Facility

The *Facilities Standards* contemplates construction of small, medium, and large full-time court facilities.

In some jurisdictions, however, small population centers that are remote to the county seat either because of travel distance or seasonal weather-related travel obstructions, are determined by the court and the Judicial Council to require a court presence. In such circumstances, the Judicial Council may elect to construct a part-time satellite court facility to ensure meaningful access to court services. Such facilities may be used to process some but not all case types in circumstances where the resulting case volume requires less than full-time courtroom services.

The Judicial Council recognizes there are circumstances in which a public need exists for part-time, single-department satellite court facilities, and also recognizes there must be proportionality between the significant construction costs associated with court facilities and the projected volume of cases in, and frequency of public visits to, such facilities.

When developing plans for a part-time court facility, the Judicial Council organization's Facilities Services office and the design professionals engaged for that purpose shall consider the case types for which the court will conduct proceedings and the anticipated frequency and volume of public visits. The Facilities Services office and the design professionals will then propose a facility design that may vary from these facilities standards with respect to design elements, including, without limitation, the size and configuration of the courtroom; the size or presence of ancillary rooms including clerks offices, judicial chambers and restrooms, and multipurpose rooms; the size and configuration of the public entrance, public lobby, and courtroom public waiting areas; and the provision of public parking.

Alternative means of construction, including prefabricated and modular construction, may be considered in the design process.

The designs for such court facilities must comply with all applicable codes and regulations more particularly stated in this *Facilities Standards* document.

8. Part-Time Specialty Court Facility

In several jurisdictions, courts maintain part-time facilities for handling specialty case types, for instance juvenile delinquency proceedings, in addition to their full-time multipurpose court facilities.

The policy announced in section 2.C.7 regarding remote single-courtroom satellite facilities, enabling variation from these facilities standards, may be similarly applied to the design and construction of such specialty facilities for the same reasons, while meeting all applicable codes and regulations stated in this *Facilities Standards* document.

2.D OCCUPANCY AND EXITING CALCULATIONS

The purpose of this section is to standardize the application of occupancy and exiting calculations for the courtrooms and adjacent areas in the design of new courthouse facilities.

1. General Method of Calculation for Occupant Load

Designers shall verify that the building exiting adequately accommodates the actual number of occupants. The occupant load factor (OLF) for each building area will be determined in accordance with the current adopted edition of the California Building Code (Cal. Code Regs., tit. 24, pt. 2) unless indicated otherwise in this document.

2. Graphic Depiction of Occupant Load on Code Diagrams

Use color tones and hatches on code diagrams on life-safety sheets to depict different occupancy classifications and areas.

3. Graphic Depiction of Fire and Smoke Areas

Use color-toned areas and hatches on the smoke control diagrams produced by the fire protection engineer on the design team.

4. Graphic Depiction of Rated Walls on Code Diagrams

Use different colored line-types, excluding red, to distinguish between walls of varying fire resistive ratings. Rated walls shall be shown on main architectural floor plans, smoke control diagrams, life safety floor plans, HVAC floor plans, plumbing floor plans, electrical floor plans, fire alarm plans, and sprinkler plans.

5. Graphic Depiction of Exiting and Path of Travel

Plans shall clearly show path of travel (POT) and means of egress from all areas and show direction of travel within all egress systems, i.e., directional arrows within stairways, exit signage on fire and life safety drawings, areas of refuge, and exit passageways. Fire and life safety drawings shall clearly show POT to the public right of way and the accumulative occupant load along the POT. This information is needed to ensure that the width of the POT is adequate for the occupant load shown (see CBC § 1004.2.1).

6. Occupant Loads in Courtrooms

Three occupant load values shall be used in courtrooms. The public seating area load shall be based on either number of fixed seats or by one person for each 18-inch length of bench. The occupant load of wheelchair spaces and the associated companion seat shall be based on one occupant for each wheelchair space and one occupant for the associated companion seat provided in accordance with CBC section 1108.2.3. Jury box shall be calculated separately and be based on the number of fixed and movable chairs in the jury box. The occupant load of the remaining courtroom well (minus area of jury box) shall be calculated using an OLF of 40 sf/person net.

7. Occupant Load in Attorney / Client Conference Rooms

These spaces shall be classified as meeting/conference rooms. The OLF shall be calculated as unconcentrated assembly at 15 sf/person net.

DIVISION ONE: DESIGN CRITERIA

- 1 General Principles
- 2 COURTHOUSE ORGANIZATION
 - 2.A Program Stacking and Zoning
 - 2.B Space Standards
 - 2.C Area and Volume Definitions
 - 2.D Occupancy and Exiting Calculations
 - 2.E Court Floor Plan for Occupancy and Exiting Analysis
- 3 Site Design
- 4 Courthouse Security
- 5 Court Set
- 6 Jury Facilities and Court Administration
- 7 Special Services
- 8 In-Custody Defendant Receiving, Holding, and Transport
- 9 Public Spaces
- 10 Building Support Services

8. Occupant Load in Public Corridor

The occupant loads in the circulation area of the public corridor shall be calculated using an OLF of 40 sf/person net (considered as part of “courtroom” base building use). In addition, the occupant load of the seating area shall be calculated by counting the total number of fixed seating or one seat for each 18-inch length of bench. Eighteen inches in front of the seating shall be excluded from the corridor load calculation, including in public corridors on the main entry level.

9. Occupant Load in Restrooms

Public and staff restrooms shall be included in the gross area calculation with an OLF of 150 sf/person.

10. Public Lobby and Elevator Lobby Transition Space

Public lobbies and elevator lobbies are transition spaces and shall have no calculated occupant load. Per chapter 2 of the CBC, a lobby is an area not defined as a waiting room at the entrance of a building through which persons must pass. Therefore, the lobby and the elevator lobby must have no other use (i.e., no benches or chairs).

11. Occupant Load in Restricted Corridor

Occupant loads in the restricted corridor shall be calculated with an OLF of 150 sf/person, using the Business use occupancy gross calculation.

12. Rated Corridors

Any room or space, in accordance with the provisions for assembly occupancies, that exceeds 100 persons (i.e., courtroom) shall have access to at least one 1-hour fire resistive corridor system.

13. Occupant Load in Jury Deliberation Rooms

Occupant loads for rooms designed exclusively for jury deliberation shall be assigned an occupant load of 14, which accounts for 12 jurors plus 2 alternates. Deviation to this occupancy load will require approval by the building official under CBC section 1004.5.

14. Occupant Load in Queuing and Waiting Areas (Business Offices & Transaction Counters)

The occupant load for queuing and waiting areas shall be calculated using an OLF of 5 sf/person net (Assembly without fixed seats, i.e., standing space).

15. Occupant Load in Courtroom Holding Cells

The OLF for courtroom holding cells shall be calculated at 1 person per 18 linear inches of fixed seating in cells plus 1 person for bailiff in each holding core.

16. Occupant Load in Judge’s Chambers and Judge’s Restrooms

Judge’s chambers, which include judge’s restrooms and robing areas, shall be calculated at an OLF of 150 sf/person gross (these spaces shall be classified as a business area).

17. Stair Width Measurement

Stairs shall be measured in accordance with figure 11.1 in chapter 11, Architectural Criteria, from inside stringer to inside stringer. In courthouses equipped throughout with an automatic sprinkler system installed in accordance with CBC section 903.3.1.1 or 903.3.1.2 and an emergency voice/alarm communications system in accordance with CBC section

907.5.2.2, the egress capacity factor shall be 0.2 inch for stairways, and 0.15 inch for door openings and other egress components. Deviations to these requirements will require approval by the building official under CBC section 1005.3.1 Exception 1 and section 1005.3.2 Exception 1.

Design stairwell clearances with tolerance. Consider fireproofing thickness for any elements that protrude into the stairwells. Avoid beams and braces penetrating in the stairwells. Provide sufficient headroom clearances in stairwells.

18. Cumulative Loading Calculations

Along the path of travel through intervening rooms and spaces, the occupant load of each space shall be cumulative in accordance with the provisions of CBC 1004.2, Cumulative occupant loads.

2.E COURT FLOOR PLAN FOR OCCUPANCY AND EXITING ANALYSIS

The floor plan in figure 2.7 is reflective of a typical courtroom floor on an upper level; it is not intended to represent the requirements of the ground floor. The plan accounts for the more restrictive code requirements of high-rise buildings. Table 2.3 shows the associated occupant load factors and other requirements. Per CBC 403.1, a high-rise-building is one that has occupied floors located more than 75 feet above the lowest level of fire department vehicle access. In some instances, these Judicial Council requirements exceed code minimums. The floor plan in figure 2.7 and the associated table 2.3 are included for illustrative purpose because the square footage of various spaces will vary from project to project. The intent of the figure and table is to illustrate the requirements specified below.

The floor plan focuses primarily on exit analysis requirements. The floor plan is diagrammatic and not intended to limit design creativity or specify exact locations or organization of spaces. Low-rise courthouses have greater flexibility relative to the location of the elevator cores and stairs, but the configuration as shown in the floor plan of those elements is recommended for high-rise buildings. The requirements for each project are distinct, and therefore each project will have a unique floor plan. However, in the interest of communicating Judicial Council requirements, the plan provides the following direction:

- a. Each occupied space shall be labeled with a room name and number
- b. An Occupant Load Table shall be included for every occupied floor level to include the following:
 - Room number
 - Room name
 - Area
 - Function (as defined by CBC table 1004.5)
 - Occupant load factor (OLF as defined by CBC table 1004.5 or per supplemental Judicial Council requirements listed herewith)
 - Net/gross area requirements (as required by CBC table 1004.5)
 - Number of fixed seats as required by CBC 1004.6
 - Occupant load based on dividing area by OLF and/or by determining the number of fixed seats
 - Details which may clarify how the occupant load was calculated

DIVISION ONE: DESIGN CRITERIA

- 1 General Principles
- 2 COURTHOUSE ORGANIZATION
 - 2.A Program Stacking and Zoning
 - 2.B Space Standards
 - 2.C Area and Volume Definitions
 - 2.D Occupancy and Exiting Calculations
 - 2.E Court Floor Plan for Occupancy and Exiting Analysis
- 3 Site Design
- 4 Courthouse Security
- 5 Court Set
- 6 Jury Facilities and Court Administration
- 7 Special Services
- 8 In-Custody Defendant Receiving, Holding, and Transport
- 9 Public Spaces
- 10 Building Support Services

- c. The exit load from each room shall be shown at each exit door and aligned with the occupant load values shown in the Occupant Load Table
- d. Cumulative occupant loads shall be indicated along the exit access route
- e. Occupant loads at each exit stair or exterior exit shall be indicated
- f. A 20 percent contingency shall be added to each occupant load discharging to exit stairs or exterior exits; a calculation at each exit stair or exterior exit shall include the following:
 - Occupant load
 - Contingency (20 percent of the occupant load)
 - Design load factor (the occupant load + contingency)
 - Egress capacity factor (typically 0.2 inches, per section 1005)
 - Calculated stairway width (design load factor × egress capacity factor)
 - Minimum stair width (per 1005.3.1 and 44 inches minimum when serving a design occupant load > 50)
 - Actual stair width (as measured between stringers)
- g. The width requirements of each door shall be shown either with a calculation for each door or a note clarifying how many occupants each standard sized door can accommodate
- h. The public lobby and the secure staff corridor shall be constructed as a corridor and protected by a one-hour fire partition at minimum
- i. Required stairwells shall be enclosed in shafts constructed as two-hour fire barriers at minimum (refer to the CBC for exceptions for stairs and elevators connecting only two floors)
- j. For high-rise buildings, each stairwell shall be accessed via a vestibule as required by 909.20.1
- k. For high-rise buildings over 420 feet in building height, an additional stairway shall be provided per CBC section 403.5.2
- l. Elevators shall be enclosed in shafts providing two-hour fire barrier construction and openings protected with either a smoke curtain or an elevator lobby meeting the same requirements (refer to the CBC for exceptions for stairs and elevators connecting only two floors)
- m. Exit travel distances from the most remote spaces on each floor to the nearest stairwells or exits shall be demonstrated
- n. For high-rise buildings, the fire service elevator and stair shall be indicated. The fire service stair must have access to the roof and must discharge directly to the exterior (may discharge through an uninterrupted exit passageway)
- o. For high-rise buildings, a fire equipment room may be required (refer to local requirements)
- p. The occupancy group for each zone shall be indicated on the plan (generally A-3 for lobbies and courtrooms, B for office areas, and I-3 for locked inmate areas)

q. The floor plan is not intended to show the following:

- The structural system
- Construction type
- Fire resistive requirements for building components:
 - Primary structural frame
 - Bearing walls
 - Nonbearing partitions
 - Floor construction
 - Roof construction
 - Shaft construction
- Exterior openings
- Protection of exterior walls and openings
- Requirements of local jurisdictions
- Mechanical, plumbing, and electrical systems and infrastructure or actual sizes of rooms
- Ground-floor requirements
- Basement-level requirements
- Roof-level requirements
- Non-court-floor requirements

DRAFT

**DIVISION ONE:
DESIGN CRITERIA**

- 1 General Principles
- 2 COURTHOUSE ORGANIZATION
 - 2.A Program Stacking and Zoning
 - 2.B Space Standards
 - 2.C Area and Volume Definitions
 - 2.D Occupancy and Exiting Calculations
 - 2.E Court Floor Plan for Occupancy and Existing Analysis
- 3 Site Design
- 4 Courthouse Security
- 5 Court Set
- 6 Jury Facilities and Court Administration
- 7 Special Services
- 8 In-Custody Defendant Receiving, Holding, and Transport
- 9 Public Spaces
- 10 Building Support Services

Table 2.2 Space Standards

DESCRIPTION	SIZE (NSF)	DESCRIPTION	SIZE (NSF)
Court Set		Court Administration	
Multipurpose Courtroom	1,600–2,050*	Public Counter Queuing	14/person
Large Courtroom	2,000–2,500	Records Viewing	24/person
Arraignment Courtroom	1,800–2,300	Training Rooms	
Chambers (incl. private toilet)	400	Large	1,100-1,600
Staff/Reception/Wait 1 person	100–140	Medium	800
Staff/Reception/Wait 2 person	140–200	Small	550
Copy/Workroom/ Supply Area	80–100	IS Workroom and Storage	150–300
Court Reporter's Workstation	48–64	Active Records Storage	
Research Attorney Work Area	80–150	Inactive Records Storage	
Staff Toilet Room	60	Staff Break Area	
Jury Deliberation Room (including toilet)	400	Lactation Room	50
Attorney Interview Room	per Catalog	Private Office	
Entry Vestibule	64	CEO	240–300
Law Enforcement Waiting Room	100	Large	150–200
Courtroom Exhibit/Evidence Storage	50	Medium	120–150
Jury Assembly Facilities		Standard	100
Entry Queuing Area	10%–25% of jury call†	Mediator	120–150
Reception/Registration	0–300	Workstation	
Jury Assembly Room	12–20/juror	Large	64
Forms Counter	3%–10% of jury call†	Standard	48
Coffee and Snack Area	115	Counter Workstation	40–48
Staff Workstation	48	Conference Room	
		Large (16–20 people)	420
		Medium (8–12 people)	280
		Small (4–6 people)	140

Table 2.2 continues on next page

Table 2.2 Space Standards *continued*

DESCRIPTION	SIZE (NSF)	DESCRIPTION	SIZE (NSF)
Family Law Facility / Self-Help Center		Public Areas	
Waiting	14/person	Public Queuing Area	14/person
Reception/Sign-in	40–60	Security Screening Station	250
Orientation Room	150–200	Information Kiosk or Counter	48
Workshop	375–400	Courtroom Public Waiting	220 ea.
Mediation Room	120–150	Public Toilet Rooms	*
Child Waiting	120 + 20/child	Public Transaction Counter	40–60/station
Security Station	50–80		
Equipment Storage	100	Building Support Services	
Alternative Dispute Resolution		Janitor Closet	40
Reception/Waiting	14/person	Loading Dock	*
Mediation/Arbitration Rooms	200–400	Trash & Recycling Area	*
Caucus Room	100	Media Area	100–120
Related Justice Agency Spaces		Mailroom	150–300
Multipurpose Rooms	*	Staff Toilet With Shower	80
Attorney Convenience Center	150–300	Furniture/Equipment Storage	*
Volunteer Workstation	48	Telecommunications Equip. Room	150 min.
Volunteer Coordinator	100	Telecommunications Room	90 per 120,000 SF served
In-Custody Defendant Receiving, Holding, and Transport		Electrical Room	*
Vehicle Sally Port	Size per bus dimensions*	Electrical Closet	*
Pedestrian Sally Port	50–100	Security Operations Center	150–400
Detention Control Room	100–250	Security Equipment Closet	100 min.
Central Holding Cells	per Holding Metric†		
Attorney Interview Room	per Catalog		
Courtroom Holding Core	per Catalog‡		
Storage Rooms	40–100		

Note: For small courthouses, the areas should be scaled down, and some may not be required.

CEO = court executive officer.

IS = Information Systems.

* Per programmatic, technology, equipment, or code requirements.

† Sizes determined by the Court Facilities Advisory Committee's metric approved in December 2013.

‡ Courtroom holding cores are determined by the layouts in tool 2, Catalog of Courtroom Layouts for California Trial Courts.

**DIVISION ONE:
DESIGN CRITERIA**

- 1 General Principles
- 2 **COURTHOUSE ORGANIZATION**
 - 2.A Program Stacking and Zoning
 - 2.B Space Standards
 - 2.C Area and Volume Definitions
 - 2.D Occupancy and Exiting Calculations
 - 2.E Court Floor Plan for Occupancy and Existing Analysis
- 3 Site Design
- 4 Courthouse Security
- 5 Court Set
- 6 Jury Facilities and Court Administration
- 7 Special Services
- 8 In-Custody Defendant Receiving, Holding, and Transport
- 9 Public Spaces
- 10 Building Support Services

Space standards illustrations are diagrammatic; project-specific furniture and equipment requirements should take precedence.

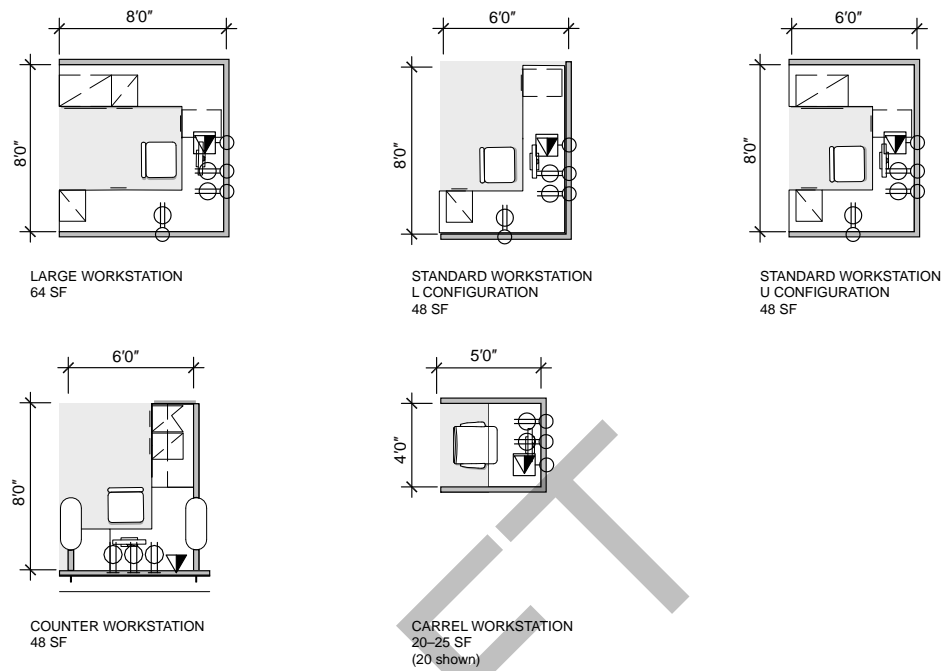

Figure 2.4 Open Plan Workstations

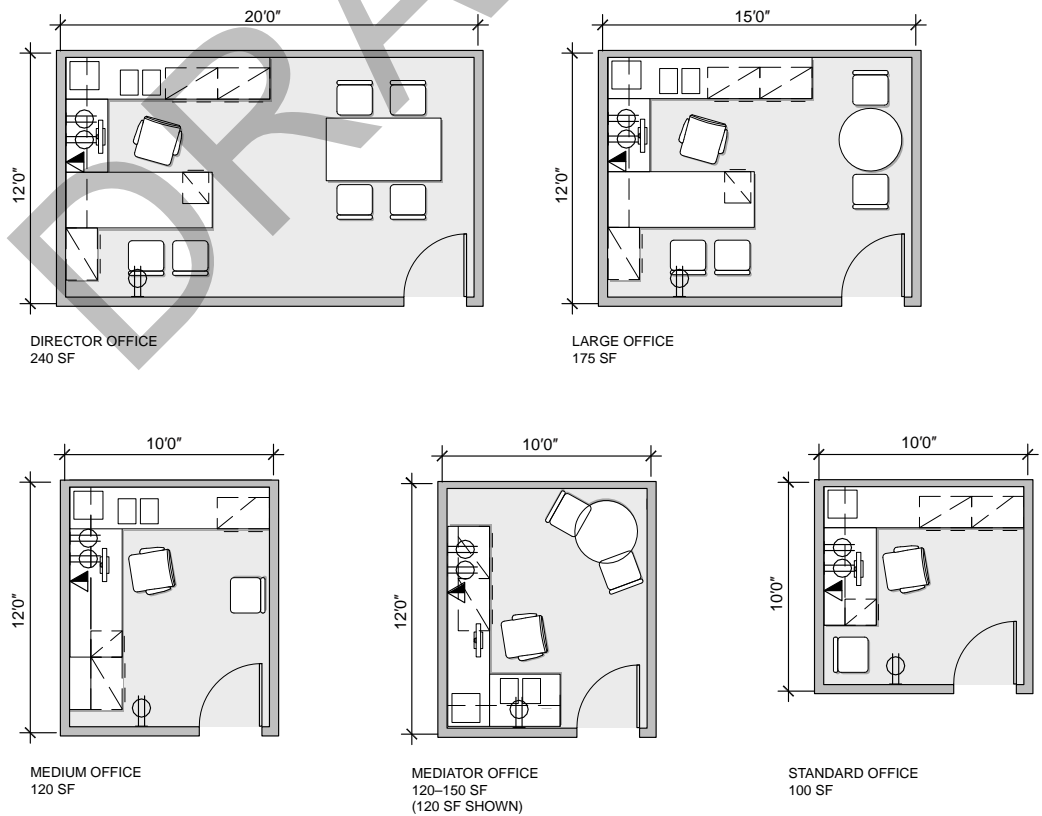
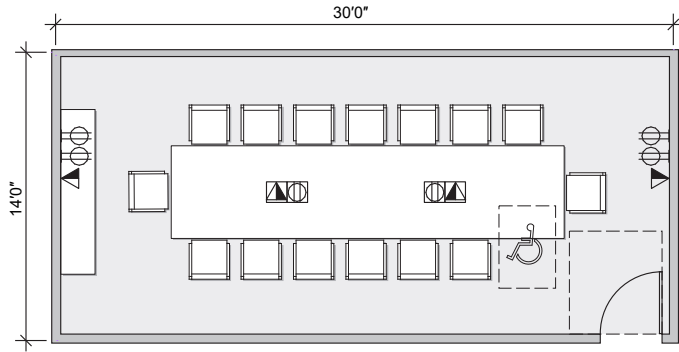
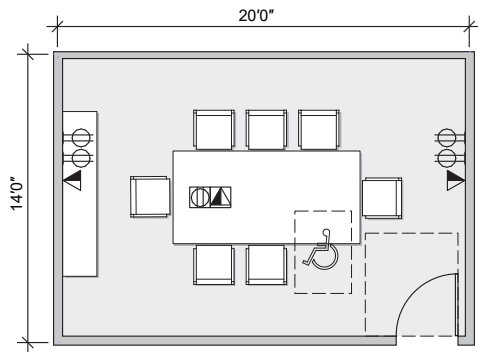

Figure 2.5 Offices



LARGE CONFERENCE ROOM
420 SF
(16 people)



MEDIUM CONFERENCE ROOM
280 SF
(8 people)

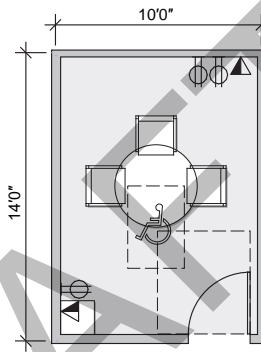

SMALL CONFERENCE ROOM
140 SF
(4 people)

Figure 2.6 Conference Rooms

**DIVISION ONE:
DESIGN CRITERIA**

1 General Principles

2 COURTHOUSE ORGANIZATION

- 2.A Program Stacking and Zoning
- 2.B Space Standards
- 2.C Area and Volume Definitions
- 2.D Occupancy and Exiting Calculations
- 2.E Court Floor Plan for Occupancy and Existing Analysis

3 Site Design

4 Courthouse Security

5 Court Set

6 Jury Facilities and Court Administration

7 Special Services

8 In-Custody Defendant Receiving, Holding, and Transport

9 Public Spaces

10 Building Support Services

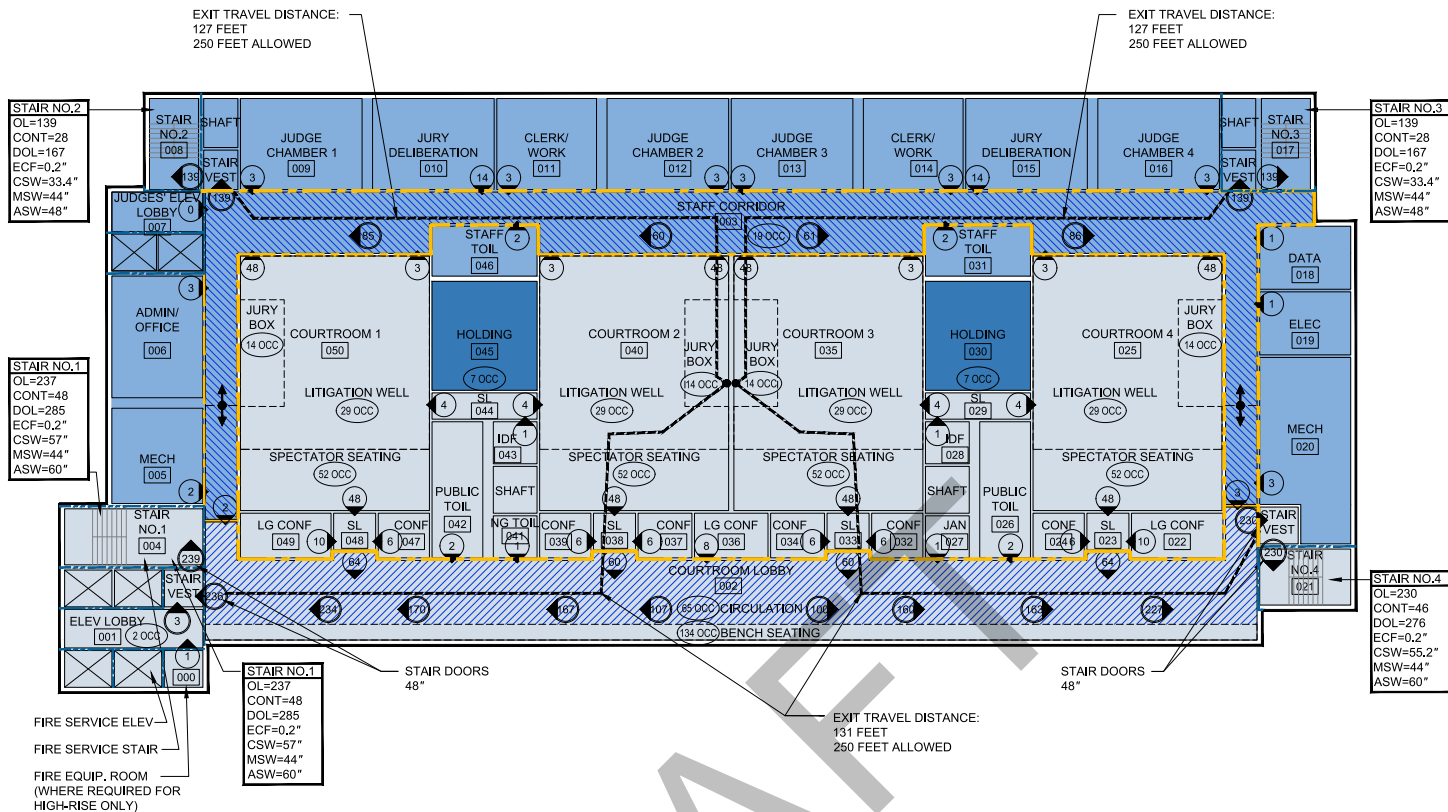

ABBREVIATIONS

OL	OCCUPANT LOAD AS CALCULATED PER SECTION 1004
CONT	CONTINGENCY (20% ADDED TO ARRIVE AT DESIGN LOAD OCCUPANCY)
DOL	DESIGN OCCUPANCY LOAD (120% OF OCCUPANT LOAD)
ECF	EGRESS CAPACITY FACTOR* PER SECTION 1005
CSW	CALCULATED STAIRWAY WIDTH PER 1005.3.1 (44 INCH MIN. REQ'D WHEN SERVING 50 OR MORE PER 1011.2)
MSW	MINIMUM STAIR WIDTH PER 1005.3.2 (44 INCH MIN. WHEN SERVING 50 OR MORE PER 1018.2 AND 1020.2)
ASW	ACTUAL STAIR WIDTH CLEAR DIMENSION BETWEEN STRINGERS
SL	SOUND LOCK
JAN	JANITOR
NG TOIL	NON-GENDER TOILET
OCC	OCCUPANTS
CONF	CONFERENCE
LG CONF	LARGE CONFERENCE
MECH	MECHANICAL
ELEC	ELECTRICAL
ELEV LOBBY	ELEVATOR LOBBY

*FOR A-3 OCCUPANCIES THE EGRESS CAPACITY FACTOR IS:
 • STAIRWAYS: 0.2 INCHES PER 1005.3.1 EXCEPTION 1 WHEN BUILDING IS EQUIPPED WITH AN AUTOMATIC SPRINKLER SYSTEM AND AN EMERGENCY VOICE/ALARM COMMUNICATION SYSTEM
 • OTHER EGRESS COMPONENTS (AISLES AND DOORWAYS): 0.15 INCHES PER 1005.3.2 EXCEPTION 1 WHEN BUILDING IS EQUIPPED WITH AN AUTOMATIC SPRINKLER SYSTEM AND AN EMERGENCY VOICE/ALARM COMMUNICATION SYSTEM

DOOR SIZING

- USING THE CALCULATIONS ABOVE FOR DOORWAYS (OTHER EGRESS COMPONENTS):
- EXIT STAIRS AND DOORS INTO THOSE STAIRS SHOULD BE DESIGNED WITH A 20% CONTINGENCY
 - A 36" DOOR (WHICH PROVIDES 32" CLEAR OPENING) CAN ACCOMMODATE 213 OCCUPANTS (32'0.15"=213.3)
 - A 42" DOOR (WHICH PROVIDES 38" CLEAR OPENING) CAN ACCOMMODATE 253 OCCUPANTS (38'0.15"=253.3)
 - A 48" DOOR (WHICH PROVIDES 44" CLEAR OPENING) CAN ACCOMMODATE 293 OCCUPANTS (44'0.15"=293.3)
 - ALL DOOR SERVING FEWER THAN 200 OCCUPANTS ARE 36 INCHES WIDTH
 - ALL DOORS SERVING 200 TO 250 OCCUPANTS ARE 42 INCHES IN WIDTH
 - ALL DOORS SERVING 250 TO 290 OCCUPANTS ARE 48 INCHES IN WIDTH
 - NO EXIT SERVES MORE THAN 290 OCCUPANTS; ADDITIONAL EXITS SHOULD BE PROVIDED
 - DOORS SWINGS SHALL NOT REDUCE THE REQUIRED WIDTH OF CORRIDORS OR STAIRS BY MORE THAN 50%.

LEGEND

- 50 EXIT LOAD
- 168 ACCUMULATIVE EXIT LOAD
- 93 OCC ROOM OCCUPANCY FOR ROOMS/SUITES WITH MORE THAN ONE EXIT
- A-3 OCCUPANCY
- B OCCUPANCY
- I-3 OCCUPANCY
- RATED CORRIDOR IN THE A-3 OCCUPANCY
- RATED CORRIDOR IN THE B OCCUPANCY
- 1-HOUR FIRE PARTITION
- 2-HOUR FIRE BARRIER

Figure 2.7 Court Floor Plan for Occupancy and Exiting Analysis

ROOM NUMBER	ROOM NAME	AREA	FUNCTION	OCCUPANT LOAD FACTOR	NET/ GROSS	NUMBER OF SEATS	OCCUPANT LOAD	DETAILS
000	FIRE EQUIPMENT ROOM	50	ACCESSORY/STOR/MECH	300	GROSS		1	
001	ELEV LOBBY	281	-	150	GROSS		0	PER JCC REQUIREMENTS
002	COURTROOM LOBBY							
002A	LOBBY SEATING	600	FIXED SEATING (200" BENCH)	NA		134	134	18" PER OCC
002B	LOBBY CIRCULATION	2,573	CIRCULATION/SEATING	40	NET		65	PER JCC REQUIREMENTS
003	STAFF (RESTRICTED) CORRIDOR	2,730	CIRCULATION/B OCC. GROSS	150	GROSS		19	PER JCC REQUIREMENTS
004	STAIR NO.1	225	-	NA			0	CIRCULATION/NOT OCCUPIED
005	MECH	315	ACCESSORY/STOR/MECH	300	GROSS		2	
006	ADMIN/OFFICE	402	BUSINESS	150	GROSS		3	
007	ELEV LOBBY	136	-	150	GROSS		0	PER JCC REQUIREMENTS
008	STAIR NO.2	162	-	NA			0	CIRCULATION/NOT OCCUPIED
009	JUDGE CHAMBER 1	402	BUSINESS	150	GROSS		3	PER JCC REQUIREMENTS
010	JURY DELIBERATION	277	FIXED SEATING	NA			14	
011	CLERK/WORK	329	BUSINESS	150	GROSS		3	PER JCC REQUIREMENTS
012	JUDGE CHAMBER 2	402	BUSINESS	150	GROSS		3	PER JCC REQUIREMENTS
013	JUDGE CHAMBER 3	402	BUSINESS	150	GROSS		3	PER JCC REQUIREMENTS
014	CLERK/WORK	329	BUSINESS	150	GROSS		3	PER JCC REQUIREMENTS
015	JURY DELIBERATION	277	FIXED SEATING	NA			14	
016	JUDGE CHAMBER 4	402	BUSINESS	150	GROSS		3	PER JCC REQUIREMENTS
017	STAIR NO.3	162	-	NA			0	CIRCULATION/NOT OCCUPIED
018	DATA	208	ACCESSORY/STOR/MECH	300	GROSS		1	
019	ELEC	208	ACCESSORY/STOR/MECH	300	GROSS		1	
020	MECH	615	ACCESSORY/STOR/MECH	300	GROSS		3	
021	STAIR NO.4	162	-	NA			0	CIRCULATION/NOT OCCUPIED
022	LG CONF	148	ASSEMBLY W/TABLES/CHAIRS	15	NET		10	
023	SL (SOUND LOCK)	56	-	NA			0	CIRCULATION/NOT OCCUPIED
024	CONF	83	ASSEMBLY W/TABLES/CHAIRS	15	NET		6	
025	COURTROOM 4							
025A	LITIGATION WELL	1,160	COURTROOMS-W/O FIX SEATS	40	NET		29	PER JCC REQUIREMENTS
025B	JURY BOX	169	FIXED SEATING			14	14	PER JCC REQUIREMENTS
025C	SPECTATOR SEATING	420	FIXED SEATING			52	52	PER JCC REQUIREMENTS
026	PUBLIC TOILET	250	-	150	GROSS		2	
027	JAN	67	ACCESSORY/STOR/MECH	300	GROSS		1	
028	IDF	67	ACCESSORY/STOR/MECH	300	GROSS		1	
029	SL (SOUND LOCK)	100	-	NA			0	CIRCULATION/NOT OCCUPIED
030	HOLDING	415	FIXED SEATING	NA		6	7	+1 FOR ADA
031	STAFF TOIL	160	-	150	GROSS		2	
032	CONF	83	ASSEMBLY W/TABLES/CHAIRS	15	NET		6	
033	SL (SOUND LOCK)	56	-	NA			0	CIRCULATION/NOT OCCUPIED
034	CONF	87	ASSEMBLY W/TABLES/CHAIRS	15	NET		6	
035	COURTROOM 3							
035A	LITIGATION WELL	1,160	COURTROOMS-W/O FIX SEATS	40	NET		29	PER JCC REQUIREMENTS
035B	JURY BOX	169	FIXED SEATING		NET	14	14	PER JCC REQUIREMENTS
035C	SPECTATOR SEATING	420	FIXED SEATING			52	52	PER JCC REQUIREMENTS
036	LG CONF	119	ASSEMBLY W/TABLES/CHAIRS	15	NET		8	
037	CONF	87	ASSEMBLY W/TABLES/CHAIRS	15	NET		6	
038	SL (SOUND LOCK)	56	-	NA			0	CIRCULATION/NOT OCCUPIED
039	CONF	83	ASSEMBLY W/TABLES/CHAIRS	15	NET		6	
040	COURTROOM 2							
040A	LITIGATION WELL	1,160	COURTROOMS-W/O FIX SEATS	40	NET		29	PER JCC REQUIREMENTS
040B	JURY BOX	169	FIXED SEATING			14	14	PER JCC REQUIREMENTS
040C	SPECTATOR SEATING	420	FIXED SEATING			52	52	PER JCC REQUIREMENTS
041	NG TOIL (NON GENDER)	67	-	150	GROSS		1	
042	PUBLIC TOILET	250	-	150	GROSS		2	
043	IDF	67	ACCESSORY/STOR/MECH	300	GROSS		1	
044	SL (SOUND LOCK)	100	-	NA			0	CIRCULATION/NOT OCCUPIED
045	HOLDING	415	FIXED SEATING	NA		6	7	+1 FOR ADA
046	STAFF TOIL	160	-	150	GROSS		2	
047	CONF	83	ASSEMBLY W/TABLES/CHAIRS	15	NET		6	
048	SL (SOUND LOCK)	56	-	NA			0	
049	LG CONF	147	ASSEMBLY W/TABLES/CHAIRS	15	NET		10	
050	COURTROOM 1							
050A	LITIGATION WELL	1,160	COURTROOMS-W/O FIX SEATS	40	NET		29	PER JCC REQUIREMENTS
050B	JURY BOX	169	FIXED SEATING			14	14	PER JCC REQUIREMENTS
050C	SPECTATOR SEATING	420	FIXED SEATING			52	52	PER JCC REQUIREMENTS
TOTAL							745	

Table 2.3 Occupant Load Factors and Other Requirements

DRAFT

3

DIVISION ONE: DESIGN CRITERIA

SITE DESIGN

SECTION	TOPIC	PAGE
3.A	Objectives	3.2
3.B	Parking	3.2
3.C	Site and Building Security	3.5
3.D	Integration of Building and Site	3.5



Superior Court of California, County of Kings
Hanford, CA
DLR Group

Courthouse Site Design Shall

- Provide a safe yet accessible environment;
- Use site design to engage and reinforce the architectural design principles and;
- Provide secure and public parking, and appropriate loading areas, as determined by the program.

3.A OBJECTIVES

The selection of a site affects the building design, the building's users, and the surrounding area. To provide the courts with the most well-located and thoughtfully sited facilities, the project team must consider the following:

- Initial and life cycle costs, including site development and site purchase, which should include features that have ongoing maintenance costs (i.e., landscaping and irrigation).
- Convenience and access to public transportation, major roads, and parking. This consideration may predetermine the location in areas with existing infrastructure and transit systems.
- Utility infrastructure.
- Proximity to existing and planned future justice agencies and detention facilities.
- Visibility and dignity of the location for an important civic building.
- Community and regional context. Local community groups' points of view must be considered in the design process. The siting of the court facility should take into consideration and ideally improve the existing context by complying with local restrictions and planning mandates, such as compatibility with neighboring land use and view corridors.
- Effect on the environment. Selection of sites requiring reclamation and cleanup, or sites with historic buildings, may reduce environmental impact and serve as successful examples of reuse.
- Site orientation. Sites with a longer east-west axis should be preferred, within plus or minus 15 degrees of geographical east-west, to allow a longer south-facing façade for optimal solar orientation.

The selection of an appropriate and successful site will serve the best interests of the courts, building users, and the community. The Judicial Council organization's Administrative Director has the final authority for approving a site for acquisition.

3.B PARKING

The transportation contexts in which trial court facilities will be designed and built vary greatly throughout the state and have changed over time. Certain communities limit the amount of parking to shift people into public transit; some communities are not served by public transit. Parking in surface lots or structures requires large amounts of land and funds for capital construction, operation, and maintenance. The public may equate convenient access to the justice system with easy access to inexpensive parking. Therefore, parking demands and solutions must be carefully considered for each new or expanded court building.

1. Electric Vehicle Charging Stations

Electric vehicle (EV) charging stations shall be provided as required by California Code of Regulations, title 24 in parking areas. Projects shall provide equitable distribution of EV charging stations among all parking areas provided. Charging stations must incorporate a mechanism for receiving payment for use, to be coordinated per the project-specific site requirements.

New projects shall provide infrastructure and facilities for EV charging stations, EV-capable spaces, and EV-ready spaces as outlined in Title 24.

2. Public Parking

Study access to and availability of adjacent public parking for staff, visitors, and jurors before determining how to provide parking for each new or expanded court building. Study public transit service to the site, as parking demand may be correspondingly reduced. Consider shared parking agreements with adjacent property owners, to use existing parking with demand times that might be different from those of the trial court. In areas where the public typically expects to pay for parking, it is consistent to expect visitors, jurors, and staff to pay prevailing rates for parking in adjacent public or privately operated parking lots and structures.

If public parking is provided, calculate parking requirements as 2.34 spaces per 1,000 building gross square feet, which is a metric that the Court Facilities Advisory Committee approved in July 2013 for planning onsite parking for use by the public, jurors, and court staff. Application of the metric described above does not preclude site-specific parking studies from being conducted or consideration of factors to reduce or increase onsite parking requirements, such as the following:

- The size and location of the courthouse, number of courtrooms, and types of matters to be heard.
- Public transit availability and expected public transit use. Staff parking demands can be reduced through traffic management plans, such as carpooling and public transportation programs.
- The average number of attorneys, visitors, and jurors expected daily; the expected length of stay for each type of parking user.
- Availability of parking within a three- to five-minute walk from the facility.
- The number of employees at the facility; existing employment agreements regarding provision of parking.
- The average number of official vehicles expected daily at the site.

Demand for parking spaces at court facilities is not well documented by empirical studies. Limited data gathered by Facilities Services staff indicate a parking demand for all courthouse users except judicial officers ranging from 2 to 4 spaces per 1,000 gross building square feet. There is no single standard for parking. The characteristics of individual court projects such as geographic location, number of courtrooms and court calendars, number of employees, proximity to downtown and to transit systems, shared parking with other departments, and land uses—as well as users’ perspectives of existing parking supply or transit—all affect parking demand.

Transportation demand management (TDM) measures can be effective in reducing parking demand if applied to the three components of parking demand: jurors, visitors, and employees. TDM measures may differ for each group. An integrated parking management strategy using more than one TDM measure can reduce parking demand by 20 to 40 percent and improve convenience for those who use the parking.

3. Secure Parking

- a. Provide secure parking adjacent to or within the courthouse for each judicial officer, the court executive officer, and a small number of staff who may require secure parking. See figure 3.1. If secure parking is provided beneath the courthouse, separate private elevator access from the secure parking area to private court spaces shall be provided. Other requirements for vehicular access to security areas are provided in chapter 4, Courthouse Security.

DIVISION ONE: DESIGN CRITERIA

- 1 General Principles
- 2 Courthouse Organization

3 SITE DESIGN

- 3.A Objectives
- 3.B Parking
- 3.C Site and Building Security
- 3.D Integration of Building and Site

- 3 Site Design
- 4 Courthouse Security
- 5 Court Set
- 6 Jury Facilities and Court Administration
- 7 Special Services
- 8 In-Custody Defendant Receiving, Holding, and Transport
- 9 Public Spaces
- 10 Building Support Services



Figure 3.1 Secure Parking, Vista Courthouse, San Diego County

- b. On-grade parking spaces, except for accessible spaces, shall be 8'6" × 18'. On-grade parking should range from 280 to 300 gross square feet (GSF) per space, assuming a 24' drive aisle for double-loaded 90-degree layouts and some stormwater pollution prevention plan elements. Parking space depth can overhang a planting area by 1'6", as in figure 3.2. Angled-parking-space layouts are also acceptable if designed efficiently.

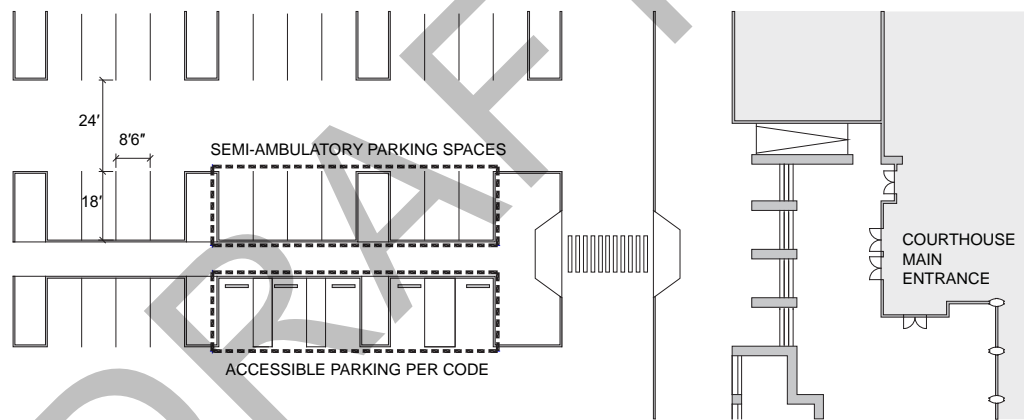

Figure 3.2 Parking Layout Showing Location of Accessible and Semi-ambulatory Spaces

- c. Following are guidelines for structured parking space efficiencies:
- A 27'6" × 64' bay should range from 350 to 375 GSF/space.
 - A 30' × 64' bay should range from 375 to 400 GSF/space.
 - A 36' × 30' bay should range from 350 to 360 GSF/space.
- d. Consider the size of structural bay spacing, type of structure, column sizes, and location of columns in relation to the front or back of the parking space.

4. Accessible Parking

Provide accessible parking spaces in the quantities required by code relative to the overall size of the parking lot and located adjacent (or as close as possible) to the building entry. Some project sites include no provision for public parking and are not immediately adjacent to existing public parking facilities with accessible parking spaces. For those sites, Facilities

Services shall initiate a dialogue with the local government entity having jurisdiction over the adjoining public streets with the goal of developing accessible parking spaces on a public street adjoining the project and as close as possible to the building entry.

5. Loading Zones

Provide a loading zone for delivery vehicles that do not need to use the loading dock, or where a loading dock is not provided.

3.C SITE AND BUILDING SECURITY

Balancing security and openness is an essential site design principle. A building can provide a safe working environment without becoming a fortress, isolated from the community. For specific security measures, see chapter 4, Courthouse Security.

3.D INTEGRATION OF BUILDING AND SITE

The following planning criteria shall apply to site design.

1. Sustainable Locations

Consideration should be taken of the environmental impact of siting decisions when making new facility investments; those concerns should be balanced with cost and security.

- a. Consider site-specific, long-term climate change impacts such as drought, flood, wind, and wildfire risks.
- b. Prioritize sites that offer robust transportation options—including walking, biking, and transit—and minimize the combined greenhouse gas emissions of the building and associated commuter and visitor transportation emissions over the project's life.
- c. Leverage existing infrastructure, and align, where possible, with local and regional planning goals; protect natural, historic, and cultural resources.

2. Orientation

- a. Consider airflow and microclimate when siting buildings:
 - In hot climates, maintain airflow around buildings to reduce interior temperatures.
 - Avoid creating enclosed areas, which can block airflow.
 - Orient the buildings along an east-west axis for longer north- and south-facing façades.
 - Maximize solar orientation for outdoor seating and to cool the buildings. In hot climates, position the building on the site to minimize the solar exposure on façades enclosing permanently occupied space.
 - Consider orientation for purposes relating to daylighting, glare, solar gain, and passive solar heating.
- b. Orient main entrances of new buildings toward pedestrian areas, to facilitate safe and barrier-free access.
- c. Orient buildings to take advantage of views; conversely, in new buildings, do not block major view corridors. Orientation for views should not compromise optimal solar orientation.

DIVISION ONE: DESIGN CRITERIA

- 1 General Principles
- 2 Courthouse Organization

3 SITE DESIGN

- 3.A Objectives
- 3.B Parking
- 3.C Site and Building Security
- 3.D Integration of Building and Site

- 3 Site Design
- 4 Courthouse Security
- 5 Court Set
- 6 Jury Facilities and Court Administration
- 7 Special Services
- 8 In-Custody Defendant Receiving, Holding, and Transport
- 9 Public Spaces
- 10 Building Support Services

Scale and function of landscape materials shall be appropriate to the region, site climate, neighborhood context, security, and functional requirements of a California courthouse.

- d. Create spaces for programmed outdoor uses, scaled to the intended activity. Locate outdoor sitting and service areas away from building air intake units, to minimize the intake of smoke and exhaust fumes.

3. Massing

Building shape, size, and scale contribute to a facility's architectural and visual character. To convey human scale, and not overwhelm court users, massing and scale of all-new construction shall be considered during planning and design.

- a. Building height and coverage may respect local zoning regulations, although such regulations do not strictly apply to state buildings.
- b. Detail of architectural elements of large buildings should maintain a sense of scale and sensitivity to the neighborhood context. Consider the visual and environmental effects that new and existing structures will have on the neighborhood and on existing buildings located in the sphere of influence caused by shading or reflectance, changes in airflow, and views to and from existing buildings.

4. Pedestrian Access

Access to and from the courthouse must be safe, convenient, and consistent with Universal Design principles.

5. Building Entrances

- a. Provide a single building entrance for visitors, staff, and the public, to facilitate cost-effective security operations. See figure 3.3 for an illustration. For large courthouse projects, the Court Facilities Advisory Committee may approve the addition of a second entrance, if warranted.
- b. Provide a separate entrance for judges and bench officers. See chapter 4, Courthouse Security, for specific security requirements.
- c. Provide two flagpoles prominently located near the public entrance and of a height scaled in accordance with the building position such that the flags unfurled on these poles will not interfere with the surveillance camera coverage or landscape trees. Provide one pole each for the State of California flag and the U.S. flag.

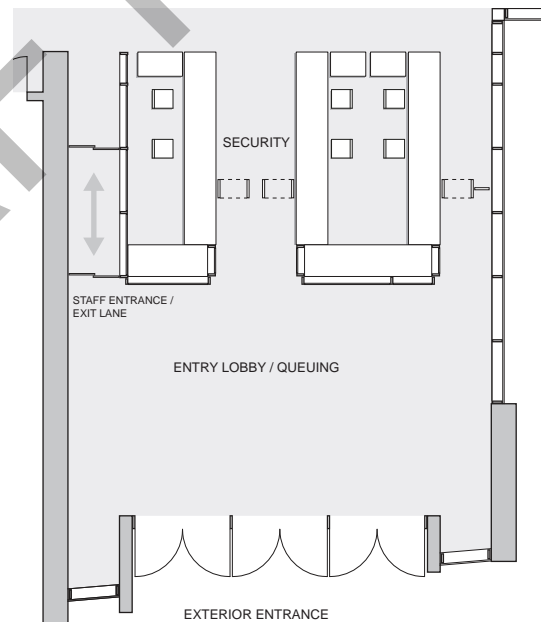

Figure 3.3 Illustration of a Single Entrance Lobby for the Courthouse Building

6. Site Utilities

- a. Design the location and visibility of utilities to minimize impact on the landscape.

- b. For service areas and above-grade utilities, including backflow preventers, standpipes, gas docks, and emergency generators:
 - Ensure that locations accommodate long-term maintenance requirements and minimize conflicts with landscape design;
 - Locate enclosures away from primary entries, or if not possible, cluster components and screen from entries and primary pedestrian paths using appropriate lighting, materials, and planting material; and
 - Consider maintenance access and serviceability requirements for site-located equipment (e.g., consider access for fuel delivery trucks when locating emergency generators on the site).
- c. For underground utilities, including electrical substations, manholes, controlled environment vaults, and steam service:
 - If possible, consolidate under roads, walks, and plazas to minimize impact on the landscape;
 - Locate surface hatches, utility covers, ventilation, and access elements within paved areas, but if planted areas are the only option, integrate into shrub and ground cover plantings to conceal appearance; and
 - Conceal vault covers in modular paving areas.

7. Landscape Design

Provide a related group of landscape materials, to promote continuity throughout the site. The following landscape design standards apply.

- a. Configure landscape elements per Crime Prevention Through Environmental Design strategies. See chapter 4, Courthouse Security.
- b. Provide visual focus for the public entry and the path to it with appropriate planting scale and plant placement.
- c. Define outdoor spaces consistently and with appropriate scale and function throughout the premises.
- d. Design landscaping features so as not to compromise video and staff surveillance of the building or create hiding places.
- e. Avoid use of landscaping that abuts the building surface to prevent water leakage. Provide adequate moisture control along the foundation walls.
- f. Green walls, planters on the roof, underground landscaped plazas, and green roofs are prohibited because of maintenance concerns. Water features and fountains are also not permitted.
- g. Integrate green building and Leadership in Energy and Environmental Design (LEED) principles, when possible, in landscape and building design.
- h. Use landscaping and building configuration to shade and provide sound, sun, and wind buffering for outdoor spaces and pedestrian areas. Provide shading on southern and western building elevations.
- i. Consider surface parking lot shading in areas not already designed to incorporate solar carport systems, with a minimum of one canopy shade tree for every 10 parking spaces.

DIVISION ONE: DESIGN CRITERIA

- 1 General Principles
- 2 Courthouse Organization
- 3 SITE DESIGN**
 - 3.A Objectives
 - 3.B Parking
 - 3.C Site and Building Security
 - 3.D Integration of Building and Site
- 3 Site Design
- 4 Courthouse Security
- 5 Court Set
- 6 Jury Facilities and Court Administration
- 7 Special Services
- 8 In-Custody Defendant Receiving, Holding, and Transport
- 9 Public Spaces
- 10 Building Support Services

- j. Consider using light-colored pavement (i.e., cool pavement), which has high solar reflectance (high albedo), to mitigate heat island effect.
- k. Respect sustainable performance goals described in 1.D, Sustainable Design, to reduce maintenance and irrigation requirements by giving preference to regionally appropriate plant species and by using natural strategies to protect and restore water resources. Nonpotable-water connection with the local water utility systems should be evaluated for use in landscape irrigation.
- l. Use natural strategies to protect and restore water resources. Limit disruption to existing vegetated areas. To purify runoff and promote groundwater recharge, use natural storm water treatment systems such as bioretention, bioswales, and permeable paving or structural permeable parking systems.
- m. Design landscape elements to prevent unsightly damage by vandalism, birds, trash, transients, or skateboarders, where necessary.
- n. Consider the maintenance requirements of tree and planting selections (i.e., pruning and seasonal cleanup requirements of selected vegetation species). Consider appropriateness of location for certain plant species relative to the site's climate and solar exposure. Consider the location of specific species within the site boundaries (e.g., tree species selected for parking lots should provide shade, but not drop excessive debris on parked cars). Trees shall be planted at least 6 feet away from building exterior envelope to prevent damage to the structure from tree roots.
- o. Take into consideration the abundance of smokers at courthouses when selecting planting, landscaping sprinkler systems, and mulch material. Dry mulch and certain plant types and grasses near walkways are vulnerable to fires from tossed cigarettes. Provide cigarette urns (secured to concrete pad or walk) at key areas of public access and gathering.

DRAFT

DIVISION ONE: DESIGN CRITERIA

4

COURTHOUSE SECURITY

SECTION	TOPIC	PAGE	SECTION	TOPIC	PAGE
4.A	Objectives	4.2	4.H	Electronic Security Planning Criteria	4.16
4.B	Design, Technology, and Operations	4.2	4.I	Electronic Security Systems	4.20
4.C	Factors Affecting Security Levels	4.3	4.J	Bullet-Resistant Glazing and Panels	4.22
4.D	Risk Assessment Procedures	4.4			
4.E	Physical Security Planning Criteria ..	4.4			
4.F	Structural Systems	4.13			
4.G	Mechanical, Electrical, and Fire Protection Systems	4.15			

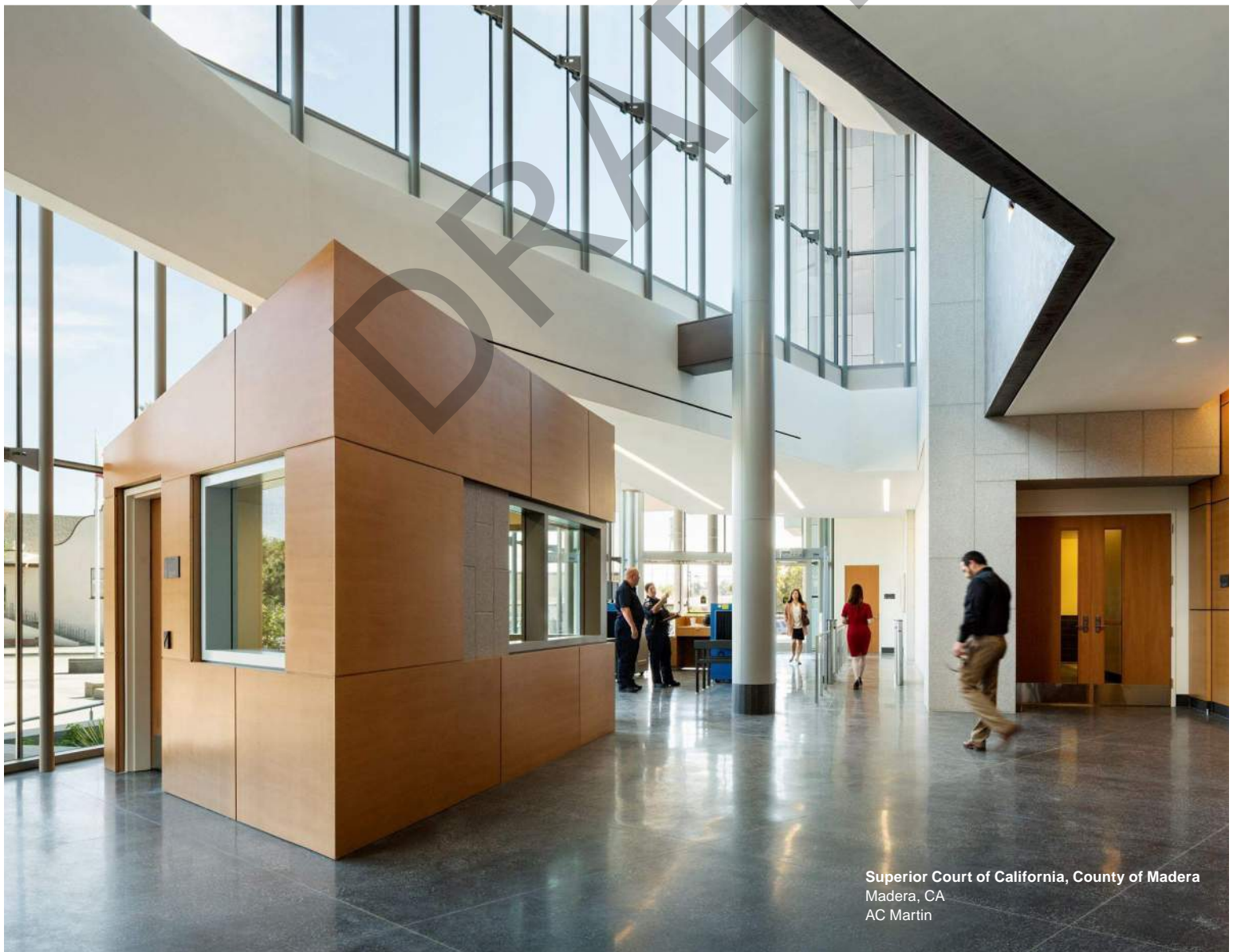

"Courthouses must be a safe harbor to which members of the public come to resolve disputes that often are volatile. Once courthouses themselves are perceived as dangerous, the integrity and efficacy of the entire judicial process are in jeopardy."

Ronald M. George
Former Chief Justice
of California

For security relating to in-custody defendants, see chapter 8, In-Custody Defendant Receiving, Holding, and Transport.

For electronic systems' infrastructure, see chapter 15, Electrical Criteria, and chapter 17, Network and Communication Systems.

Courthouse security planning must ensure a safe and secure environment for all users of the court and must protect the functions and assets of California court facilities. Balancing security, accessibility, and comfort in civic buildings presents myriad challenges. Security planning and design must anticipate terrorist events, chemical and biological attack, natural disasters, emergencies, power outages, crime, and workplace violence. It is of paramount importance that building systems be designed and maintained to protect public health and life safety. The design should provide direct egress routes for rapid and safe evacuation of building occupants to the outside. These guidelines represent best practices to maximize public security and personal safety. The security planning process is most effective when integrated into the courthouse design at an early stage. Terminology related to building level of protection and component damage levels is defined in *U.S. Army Corps of Engineers Protective Design Center Technical Report PDC-TR 06-08 Rev. 1* and incorporated herein as referenced below.

4.A OBJECTIVES

Courthouse security planning and design shall be based on a site-specific risk assessment and will:

- Provide a safe and secure environment for all building occupants;
- Maintain continuous operations until building inhabitants can evacuate to a safer area;
- Provide security and confidentiality of critical information;
- Enable security and court personnel to maintain control during normal and disrupted operations; and
- Be responsive to the risk assessment.

4.B DESIGN, TECHNOLOGY, AND OPERATIONS

1. Approach

A comprehensive court facility security design approach integrates design, technology, and operations, including policies, procedures, and personnel. The most effective security approach is achieved when these three elements are coordinated during early project phases.

- a. Design comprises architectural elements and engineering systems, including space planning, adjacencies, user group zoning, and passive physical protection; doors, locks, and site perimeter barriers; exterior lighting and egress and circulation system; and all building systems relating to building evacuation.
- b. Technology includes electronic security systems and equipment, such as weapons screening, automated access controls, alarm monitoring, duress alarms, remote door and gate controls, and video surveillance.
- c. Operations refers to policies and procedures for the court facility, and those for security program management, security staffing, and employee training.

2. Elements

This chapter addresses design and technology planning criteria. When developing a facility security design approach, the project team must understand the essential role of operations and staffing levels because they are directly related to the ability to provide a safe environment and they affect annual operating costs and budgets. As figure 4.1 illustrates, architectural elements, electronic systems, and security staff and procedures are the significant elements of a security plan.

- a. Security planning must consider and reflect security staffing levels at each facility. The project team shall develop a comprehensive plan with court administration and courthouse security personnel to understand operating policies, procedures, and projected security staffing levels (refer to chapter 8 for the sheriff’s Operational Program Statement related to in-custody movement and detention).
- b. Technology and electronic systems shall be coordinated with architectural and engineering systems and with building operations.
- c. The Operational Program Statement, together with the risk assessment measures and the security and detention space program are key elements of a comprehensive security approach, which shall be prepared for each new court building project—ideally in the program verification or predesign phase.

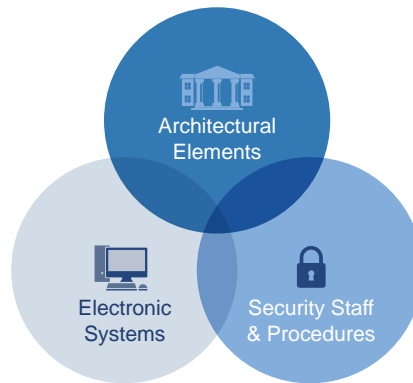

Figure 4.1 Security Plan Elements

4.C FACTORS AFFECTING SECURITY LEVELS

New court facilities vary in size, complexity, types of cases handled, threats, and geographic location. Court facilities may, in some instances, be colocated with other public or private uses. Security design may be influenced by:

- Size of court operation: Loss of use or destruction of a facility would have a significant impact on the courts and the community.
- Types of cases: Juvenile and family courts have a high risk of confrontation, assault, and violent behavior. Criminal courts require security measures to ensure safe handling of individuals in detention.
- Threats: History of incidents or threats may be interpreted as a site-specific increased risk factor. Intelligence from local police, the sheriff, the California Highway Patrol, and the Federal Bureau of Investigation shall also be considered.
- Location: Adjacent facilities, such as federal and public buildings, symbolic targets, and landmarks, may pose a threat to a court facility. High-crime neighborhoods, as identified by crime risk survey data, may result in increased security risks. Measures may be required to mitigate substandard site characteristics such as lack of building setback distances, limited parking arrangements, and sightlines from adjacent buildings or landscapes into chambers windows.

1. Courthouse Risks

The project team will provide appropriate security design elements and countermeasures to mitigate potential risk and damage under the findings and recommendations of the risk assessment conducted by the Judicial Council’s Emergency Planning and Security Coordination unit. Refer to 4.D, Risk Assessment Procedures. Per the National Center for State Courts, security risks for new courthouses include:

DIVISION ONE: DESIGN CRITERIA

- 1 General Principles
- 2 Courthouse Organization
- 3 Site Design

4 COURTHOUSE SECURITY

- 4.A Objectives
- 4.B Design, Technology, and Operations
- 4.C Factors Affecting Security Levels
- 4.D Risk Assessment Procedures
- 4.E Physical Security Planning Criteria
- 4.F Structural Systems
- 4.G Mechanical, Electrical, and Fire Protection Systems
- 4.H Electronic Security Planning Criteria
- 4.I Electronic Security Systems
- 4.J Bullet-Resistant Glazing and Panels
- 5 Court Set
- 6 Jury Facilities and Court Administration
- 7 Special Services
- 8 In-Custody Defendant Receiving, Holding, and Transport
- 9 Public Spaces
- 10 Building Support Services

CPTED = Crime Prevention Through Environmental Design

Basic CPTED Strategies

- Natural surveillance
- Natural and constructed access control
- Territoriality

- Violent or assaultive behavior directed against staff, judicial officers, the public, or detainees;
- Damage to physical facilities and theft of property, including money;
- Disruption of court activities; and
- Compromise of court process, including evidence, court records, jury sequester, and due process.

2. Capability to Increase Security

The facility must be designed to accommodate changes in security requirements. For example, if a high-profile or celebrity case is assigned to a court located in a small county, security needs may temporarily increase to levels higher than normally encountered.

National, regional, and local conditions and threat levels may also affect security requirements. Examples of increased security during heightened threat and alert levels include escalating screening capacity in the lobby and increasing building setback distances between building and vehicles to protect against vehicular threats.

4.D RISK ASSESSMENT PROCEDURES

- The Emergency Planning and Security Coordination unit shall conduct a risk assessment for each project.
- The risk assessment shall identify potential threats and vulnerabilities, consider the likelihood and potential consequences of an event occurring, and recommend mitigation measures.
- The risk assessment report shall be reviewed by the Court Facilities Advisory Committee in predesign phase.
- The assessment shall be used as the reference document for project-specific solutions prepared by the architects and engineers, such as environmental deterrents, blast-resistant requirements, and electronic monitoring and control measures, including video surveillance.

Table 4.3 lists mandatory requirements and those determined by the project-specific risk assessment. Table 4.4, as well as the principles and security measures described in this chapter, shall set the scope of electronic security design elements for the site and the court building.

4.E PHYSICAL SECURITY PLANNING CRITERIA

Security-planning best practices for trial court buildings are described in this section. These practices provide the minimum physical security elements indicated or as modified and required by the project-specific risk assessment.

1. Crime Prevention Through Environmental Design (CPTED)

Permanent, effective, and visually appealing security planning solutions are the basis of Crime Prevention Through Environmental Design. CPTED principles reinforce the ability of design and the built environment to minimize crime and the fear of crime and to improve the quality of life. There are three basic CPTED strategies:

- **Natural surveillance:** The placement of physical features, activities, and people to maximize visibility—for example, proper placement of windows overlooking sidewalks and parking lots and use of transparent vestibules at building entrances to divert persons

to reception areas—can decrease the likelihood of crime in the surrounding areas of the courthouse. This strategy can be supplemented with the use of security and police patrols and the application of closed-circuit television.

- Natural and constructed access control: Natural access control focuses on limiting and providing guided access through use of properly located entrances, exits, fencing, landscaping, sidewalks and roadways, signage, and lighting. This guidance helps deter access to a crime target and creates a perception of risk to a perpetrator.
- Territoriality: The use of physical attributes that express ownership—such as fencing, pavement treatments, signage, and landscaping—promotes a perception that these areas are controlled. In an area that is physically designed to protect designated space, people are more likely to challenge intruders or report suspicious activity, and the design itself causes intruders to stand out.

Designers must comply with the findings and recommendations of the risk assessment and accommodate their impact on the operational design criteria.

Designers must apply CPTED principles in site and building master plans and in the early phases of architectural and landscape design.

2. Concentric Circles of Protection

The concept of concentric circles of protection is based on varying levels of protection originating at the site perimeter, building envelope, lobby areas, and interior specialty controlled areas, with the levels becoming increasingly more stringent as one proceeds through each level to reach the most critical areas. This concept establishes “intervention zones” between security levels; these zones provide an opportunity for control, detection, evaluation, and response to undesired activity or to intruders or other unauthorized individuals.

Where possible, the facility design should establish distinct separation of areas with differing levels of security.

3. Site Selection and Design

Vehicular and adjacency threats may be a major concern at court facilities and must be considered during site selection and site design.

The site must have a minimum 25' setback between unscreened vehicle threats and buildings, unless otherwise determined by the risk assessment.

Setback is the distance maintained between a structure or asset and the potential location of the explosive threat. Increasing setback distance greatly improves protection for the building and occupants, because blast pressure and impulse quickly decay as a function of distance. See figures 4.2 and 4.3.

By way of illustration, improvised explosive devices weigh approximately 100 pounds per cubic foot. It is reasonable to assume that 10 to 50 pounds may be transported in a hand-carried package, 50 pounds may be surreptitiously concealed within a vehicle, and 100 to 500 pounds (or more) may be transported within a vehicle. Although these magnitudes may be significantly less than the weights of explosive that may be transported by the largest vehicles accessible to the site, they correspond to the reasonable levels of blast load intensity (based on site standoff distances) that normal building materials and any feasible upgrades to the building construction can reasonably be expected to withstand.

DIVISION ONE: DESIGN CRITERIA

- 1 General Principles
- 2 Courthouse Organization
- 3 Site Design

4 COURTHOUSE SECURITY

- 4.A Objectives
- 4.B Design, Technology, and Operations
- 4.C Factors Affecting Security Levels
- 4.D Risk Assessment Procedures
- 4.E Physical Security Planning Criteria
- 4.F Structural Systems
- 4.G Mechanical, Electrical, and Fire Protection Systems
- 4.H Electronic Security Planning Criteria
- 4.I Electronic Security Systems
- 4.J Bullet-Resistant Glazing and Panels

- 5 Court Set
- 6 Jury Facilities and Court Administration
- 7 Special Services
- 8 In-Custody Defendant Receiving, Holding, and Transport
- 9 Public Spaces
- 10 Building Support Services

High-risk areas are those into which unscreened packages or vehicles may be brought.

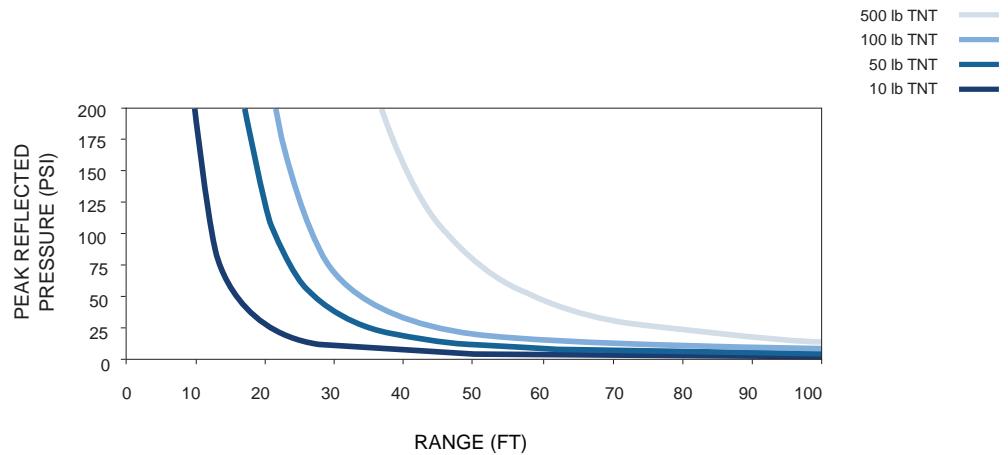
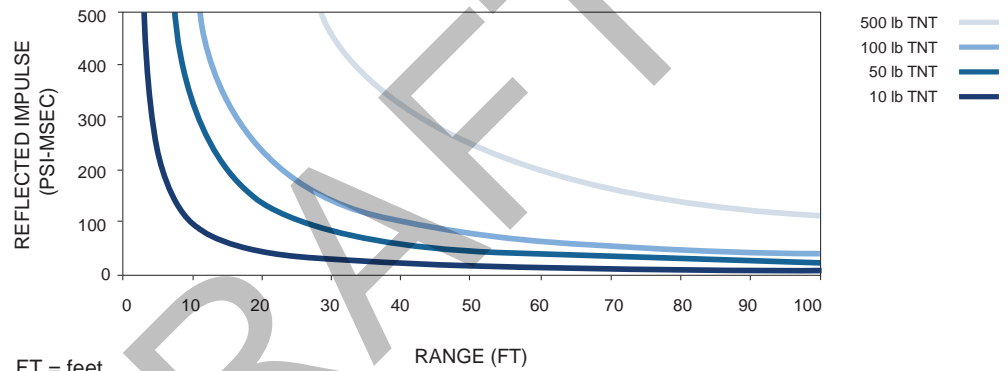

Figure 4.2 Peak Pressure Decay with Distance



FT = feet.

psi = pounds per square inch.

msec = millisecond.

Figure 4.3 Impulse Decay with Distance

The setback distance is measured from the face of the building structure, enclosure, or both to the location of the nearest parked vehicle for the passive vehicle threat and to the location of the antiram perimeter for the moving vehicle threat (see 4.E.5, Site Security). Increased setback may also reduce the cost of blast hardening as required. Every foot of setback distance is critical.

Site the building so street configurations do not create a straight, head-on approach to the facility and adjacent facilities, and so that functions do not pose significant risks or threats. Certain site configurations will require vehicle barriers (described under Site Security, below).

4. Parking Security

- a. Public parking is not allowed within or beneath the courthouse.
- b. Provide a minimum 25' setback of public parking from the courthouse, unless otherwise determined by the risk assessment.

- c. If secure parking is provided in surface lots, they shall be fenced, visually screened, and separated from public circulation pathways and parking.
- d. For secure parking in surface lots not contiguous with the court building, provide a continuous path of travel to the secure entry to the courthouse. This exterior walkway is considered a part of the court building private circulation system (see chapter 2, Courthouse Organization). The secure parking area and path of travel shall be screened from view by the public or in-custody defendants; such screen fence or wall shall deter scaling and climbing and be a minimum of 8' tall as modified by site conditions (e.g., adjacent slope, nearby equipment) or the project risk assessment.
- e. Place all onsite (unsecured) parking as far from the building as possible. Reduce or eliminate adjacencies between occupied or critical areas and spaces accessible to screened or unsecured vehicles.
- f. Minimize and control the number of vehicular access points into secure parking areas and sally ports.
- g. Provide operable barriers at entries of exterior secure and service parking areas adjacent to the courthouse, as well as interior secure parking areas.
- h. Colocate loading dock and parking garage entries.
- i. Provide a minimum 6" of nonstructural architectural finish around all columns in or adjacent to interior secure parking.
- j. If a screened vehicle threat is specified by the risk assessment, harden interior walls around interior secure parking areas where a 25' distance to critical or occupied space is not provided. Heavy damage to these interior enclosure walls is acceptable if adjacent occupied or critical space is protected and the walls are non-load-bearing. If these interior enclosure walls are load bearing, they shall be limited to superficial damage unless a high-fidelity analysis can demonstrate sufficient service load carrying capacity following a blast event. Harden interior columns in or adjacent to interior secure parking and the floor above and below interior secure parking to resist loading up to and including the specified explosive where the spaces above or below are occupied or contain critical equipment. Interior secure parking areas should be considered to include sally ports.

5. Site Security

- a. Employ CPTED principles.
- b. Place any trash receptacles or public mailboxes outside the building setback distance.
- c. Illuminate site perimeters, walkways, and drives.
- d. Ensure that trees at partial or full projected growth do not impede lighting and security cameras throughout the site.
- e. Restrict heights of landscaping to maintain natural surveillance. As a goal, avoid landscaping that will allow for concealment of packages 12" tall within the building setback distance.
- f. Protect utilities (gas, power, telephone) at entrance to the site through burial or concrete encasement.
- g. Employ physical barriers to maintain setback distances, enhance perceived protection, and create a perception of the courthouse as a hard target. The risk assessment will specify either a passive (stationary) or moving vehicle threat as well as the location of

DIVISION ONE: DESIGN CRITERIA

- 1 General Principles
- 2 Courthouse Organization
- 3 Site Design

4 COURTHOUSE SECURITY

- 4.A Objectives
- 4.B Design, Technology, and Operations
- 4.C Factors Affecting Security Levels
- 4.D Risk Assessment Procedures
- 4.E Physical Security Planning Criteria
- 4.F Structural Systems
- 4.G Mechanical, Electrical, and Fire Protection Systems
- 4.H Electronic Security Planning Criteria
- 4.I Electronic Security Systems
- 4.J Bullet-Resistant Glazing and Panels

- 5 Court Set
- 6 Jury Facilities and Court Administration
- 7 Special Services
- 8 In-Custody Defendant Receiving, Holding, and Transport
- 9 Public Spaces
- 10 Building Support Services

each, if not uniform. For a moving vehicle threat, the level of antiram resistance will be determined by the risk assessment. Threat definition and barrier selection shall be based on ASTM Standard F2656. A passive vehicle threat may be deterred using curbs, No Parking signs, striping, and the like. A moving vehicle threat must be stopped at the minimum required setback distance using an antiram barrier. The designers must select a barrier system, around the entire protected perimeter, that will stop the identified vehicular threat. Consider traffic pattern and flow relative to the site configuration. The moving vehicle threat should minimally be considered opposite pedestrian building entrances and at vehicle entrances to loading docks, sally ports, and underground parking.

- h. Barrier systems may consist of landscaping elements, fixed outdoor furniture, grade changes, planters, walls, bollards, or other antiram designs that provide the required antiram resistance and are integrated into the site or building architecture but shall not be an impediment to visual surveillance by law enforcement.

6. Building Layout

The building plan shall minimize vulnerabilities through appropriate space planning and adjacencies.

- a. Locate lobbies and delivery areas outside the main building footprint or in an exterior bay, when possible, and away from densely occupied spaces and critical facilities.
- b. Provide one shared staff and public entrance point to reduce weapons-screening operational requirements. Provide a secure path from the judges' secure parking area to judges' chambers.
- c. Provide natural or constructed surveillance for building access points.
- d. Protect buildings from vehicular threats. Public parking is not allowed within or directly adjacent to the building.
- e. Separate high-risk areas—including an unscreened lobby, loading docks, mailrooms, vehicle sally ports, and secure parking garages—from occupied spaces, critical utilities, and building systems needed to ensure rapid and safe building evacuation, including electrical, mechanical, and fire protection equipment. Do not place critical utilities at exterior walls or within 25' of high-risk areas. Do not locate occupied areas within 25' of high-risk areas.
- f. Locate emergency generators at least 50' from the primary electrical source.
- g. Colocate the loading dock and mailroom toward the building exterior.
- h. Locate all emergency egress away from high-risk areas. Provide redundant emergency egress exits, but do not cluster routes.
- i. Stack critical areas and supporting utilities.
- j. Provide ductile materials in emergency egress pathways to minimize debris.

7. Courtrooms, Judge's Chamber, and Jury Deliberation Rooms

- a. For courtrooms, provide bullet-resistant panels within the podium and bench for judge, court security officer (CSO), clerk, and witness stand (see 4.J, Bullet-Resistant Glazing and Panels).
- b. Minimize windows with direct line of sight from public areas, circulation zones, and parking garages, to prevent observation of activities, threat exposure, or communication with courtroom occupants.

- c. Where exterior windows are provided, provide ballistic glazing as determined by the risk assessment (see section 4.J).

8. Public Transaction Counters

Outdoor or unsecured public transaction counters shall be provided with bullet-resistant wall panels, transaction glazing, and pass-through drawers (see section 4.J).

9. Lobby and Waiting Areas

- a. Place unsecured lobby areas outside the main building footprint or in an exterior bay so that a blast will not damage the building frame or critical court functional areas.
- b. Eliminate trash, mail receptacles, or other areas of concealment in the unscreened lobby areas.
- c. Staffing level for screening is a primary consideration in lobby screening design. The screening configuration needs to optimize throughput with the level of staffing to be provided.
- d. Design lobby, queuing area, screening lanes, and exit lanes to accommodate direct visual surveillance by staff and security officers. Optimally, an exit lane should be located adjacent to a regularly staffed (incoming) screening lane.
- e. Design lobby for increased levels of security; this design may include additional screening areas or restriction of openings into secure areas.
- f. Provide physical barriers and indirect circulation between not secure and secure space to minimize cross contamination of screened and unscreened persons and the introduction of harmful agents or weapons.
- g. Provide a minimum 6" nonstructural architectural finish around all columns in or adjacent to the loading dock and mailroom.
- h. If explosive screening is provided and a hand-carried satchel threat is specified by the risk assessment, harden interior walls around the lobby screening area as well as the adjacent lobby or other space into which blast pressures may propagate. Heavy damage to these interior enclosure walls is acceptable as long as adjacent occupied or critical space is protected and the walls are non-load-bearing. If these interior enclosure walls are load bearing, they shall be limited to superficial damage unless a high-fidelity analysis can demonstrate sufficient service load carrying capacity following a blast event. The lobby is considered transient and is not required to be protected from the prescreening area. Harden the interior columns in or adjacent to the prescreening area and the floor above and below the unsecured lobby areas to resist loading up to and including the specified satchel explosive threat located at the lobby floor level where the spaces above or below are occupied or contain critical equipment.

10. Evidence and Exhibit Storage Rooms

- a. Locate evidence and exhibit storage rooms in private circulation areas.
- b. Exhibit storage rooms shall have full-height partitions and hard ceilings and be secured using keyed locks.
- c. Include dual authentication card readers with PINs and video surveillance at evidence room entry doors.

DIVISION ONE: DESIGN CRITERIA

- 1 General Principles
- 2 Courthouse Organization
- 3 Site Design

4 COURTHOUSE SECURITY

- 4.A Objectives
- 4.B Design, Technology, and Operations
- 4.C Factors Affecting Security Levels
- 4.D Risk Assessment Procedures
- 4.E Physical Security Planning Criteria
- 4.F Structural Systems
- 4.G Mechanical, Electrical, and Fire Protection Systems
- 4.H Electronic Security Planning Criteria
- 4.I Electronic Security Systems
- 4.J Bullet-Resistant Glazing and Panels

- 5 Court Set
- 6 Jury Facilities and Court Administration
- 7 Special Services
- 8 In-Custody Defendant Receiving, Holding, and Transport
- 9 Public Spaces
- 10 Building Support Services

Lobby Considerations

- Limit adjacencies between the unsecured portions of lobby and court offices or jury assembly spaces.
- Consider potential for mail and package deliveries to be brought in through the lobby in smaller courthouses.

Minimum Prescriptive Design Requirements

- Debris-mitigating materials
- Ductile systems
- Standoff to critical building elements
- Forced-entry protection
- Bullet resistance

Performance-Based Design Requirements

- Apply when specified by risk assessment.
- Use blast-resistant façade.
- Harden critical building elements.
- Protect occupied space and critical systems from high-risk areas.

11. Loading Dock and Mailroom

- Control access to loading dock area by means of operable barriers at entries.
- Where feasible, place loading docks and the mailroom in the exterior bay, and provide a means for venting gas pressures that may result from an internal detonation. If not possible, alternatives should be considered, such as screening incoming packages and mailing via the lobby or at a remote facility. Locate critical and occupied space at least 25' away from the loading dock and mailroom.
- Provide a minimum 6" architectural cover around all columns in or adjacent to the loading dock, shipping/receiving area, and mailroom.
- If explosive screening is provided and a package threat is specified by the risk assessment, harden interior walls around the loading dock, shipping and receiving areas, and mailroom, where a 25' distance to critical or occupied space is not provided. Heavy damage to these interior enclosure walls is acceptable as long as adjacent occupied or critical space is protected and the walls are non-load-bearing. If these interior enclosure walls are load bearing, they shall be limited to superficial damage unless a high-fidelity analysis can demonstrate sufficient service load carrying capacity following a blast event. Harden interior columns in or adjacent to the loading dock, shipping and receiving areas, and mailroom and the floors above and below them to resist loading up to and including a satchel explosive at the floor level or on the dock where the spaces above or below are occupied or contain critical equipment.

12. Building Security Operations Center (SOC)

- Locate the security operations center (SOC) to allow visual monitoring of the entrance screening area with a direct line of sight and to allow monitoring and operation of electronic security systems. Refer to figure 4.4. This space is not required in small court facilities.
- Fire command centers, required with high-rise life-safety systems, shall remain separate from the security operations center.
- If the SOC has a window overlooking the main entrance, weapons screening, and/or entrance queuing, ballistic glazing is required as determined by the risk assessment (see section 4.J). Glazing must use mirror tint or other means of obscuring vision into the SOC.
- The walls shall have bullet-resistant paneling.

13. Building Envelope

- The exterior building envelope shall be designed to minimize vulnerabilities and protect occupants from flying debris entering the building in the event of an external blast. The minimum prescriptive requirements, as described in section 13.1 of this chapter, must be provided on all projects.
- The risk assessment will specify whether a performance-based design approach is also required, in which case an unscreened exterior vehicle threat may be specified. If a performance-based approach to building hardening is required, the exterior façade systems constituting the building envelope shall resist loading up to and including the actual blast loads on the façade calculated for the specified unscreened exterior vehicle threat, up to a maximum air-blast design load of 4 psi peak pressure and 28 psi-msec impulse.

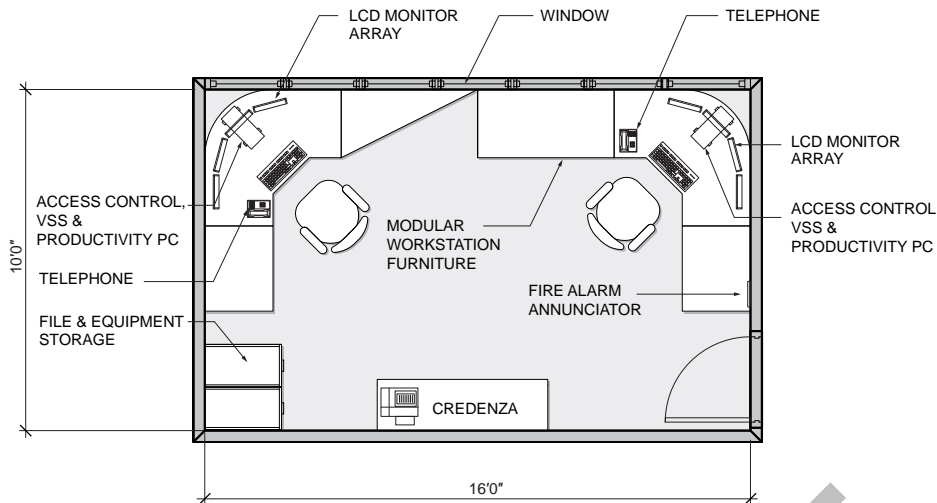

VSS = video surveillance system.

PC = personal computer.

LCD = liquid crystal display.

Figure 4.4 Plan of Security Operations Center

- c. Negative phase blast loading effects shall be considered when rebound is a design consideration under blast loading. Negative phase blast loading shall be determined assuming the charge size defined in the project-specific Risk Assessment and the analytical methods defined in United Facilities Criteria (UFC) 3-340-02.

13.1 Minimum Prescriptive Requirements

- a. Glass: The innermost pane of all exterior glass shall be laminated. Alternatively, the glass makeup (i.e., both inner and outer lights of insulated glass unit) may be panes of monolithic fully tempered glass. If monolithic fully tempered glass is to be used in lieu of laminated glass, then the only requirement is that the entire makeup be composed of fully tempered glass.
- b. Windows: Operable windows are not permitted.
- c. Doors: Lock and monitor all unscreened perimeter doors.
- d. Fenestration: Limit building envelope fenestration at critical areas such as courtrooms, chambers, and jury deliberation rooms, especially at the first level.
- e. Building exterior: Minimize blast effects by using convex shapes (toward exterior) and limited reentrant corners.
- f. Bullet-resistant glazing: Provide bullet-resistant exterior glazing in judicial chambers and courtrooms, to the extent required by the risk assessment and available line of sight from surrounding street and nearby buildings. See section 4.J.
- g. Openings' security: Provide forced-entry protection at the first floor. Forced-entry rating shall satisfy ASTM Standards F588 for windows, F476 for swinging doors, and F842 for sliding doors, as specified by the risk assessment, including required resistance grade.
- h. Walls: Use ductile systems that will minimize flying debris entering occupied spaces.

**DIVISION ONE:
DESIGN CRITERIA**

- 1 General Principles
- 2 Courthouse Organization
- 3 Site Design

**4 COURTHOUSE
SECURITY**

- 4.A Objectives
- 4.B Design, Technology, and Operations
- 4.C Factors Affecting Security Levels
- 4.D Risk Assessment Procedures
- 4.E Physical Security Planning Criteria
- 4.F Structural Systems
- 4.G Mechanical, Electrical, and Fire Protection Systems
- 4.H Electronic Security Planning Criteria
- 4.I Electronic Security Systems
- 4.J Bullet-Resistant Glazing and Panels

- 5 Court Set
- 6 Jury Facilities and Court Administration
- 7 Special Services
- 8 In-Custody Defendant Receiving, Holding, and Transport
- 9 Public Spaces
- 10 Building Support Services

Protective Structural Design

- Prescriptive threat-independent approach
- Redundant and ductile structural systems
- Resistance for disproportionate and progressive collapse
- Ductile detailing and failure modes

Courtroom doors

Refer to Litigation Area under 5.D, Courtroom Components, for a discussion of security measures.

13.2 Performance Requirements

- a. **Glass:** Design exterior glass to achieve a blast hazard rating of Low as defined by ASTM Standard F1642 in response to the specified blast loading. See table 4.1 for rebound response requirements. Ideally, the glass pane shall be as weak as possible, so as not to transmit additional load to the frames, mullions, and anchorage. Structural silicone sealant shall be used along the exterior perimeter of the pane to adhere the glass to the frame.
- b. **Window mullions, frames, and anchorage:** Design frames and anchorage to resist the calculated blast load intensity. Provide calculations or explosive testing results of identical systems to demonstrate that the façade components can resist the specified tributary blast loads without failure, including the dismemberment or premature ejection of the glass panels. The allowable rotation of mullion ends in response to the specified blast loading shall be a maximum of 3 degrees (L/40 maximum deflection). Design components using allowable stresses equal to the average expected dynamic yield strength of their respective materials; average strength factor (ASF) and dynamic increase factor (DIF) values defined in the most recent version of ASCE 59 may be used to transform minimum specified strengths to average expected dynamic strengths. Aluminum or steel mullions are preferred. Typically, curtain wall systems, including unitized systems, can be modified with deeper or thicker sections than generally used. A clear load path must be provided from the glass to the primary structure.

Table 4.1 Summary of Building Envelope Performance Requirements

Element	Performance Requirement	Design for Rebound?
Glass	Blast hazard rating of Low, as defined by ASTM F1642*	Only if required by project-specific requirements.
Window Mullions, Frames, and Anchorage	Rotation of mullion ends shall be a maximum of 3 degrees (L/40 maximum deflection)*	Yes
Doors and Door Anchorage	Performance requirement for doors to be determined on a project specific basis*†	‡
Nonglazed Façade Systems	Transfer reaction forces back to the building structure without failure*.§	§

* See section 4.E.13.2 for other requirements.

† Performance objectives may vary by door type and desired level of protection.

‡ Doors exhibiting Category III performance or worse as defined in ASTM F2247 shall be designed for rebound only if required by project-specific requirements. Doors exhibiting Category II performance or better as defined in ASTM F2247 shall be designed for rebound.

§ Parallels can be drawn between glazed and nonglazed façade systems: a low level of protection should be provided for glass/paneling and a medium level of protection should be provided for the supporting framing system. Rebound should be considered in the design of the supporting framing system, and anchorage; rebound of the glass/paneling should be considered only if required by project-specific requirements.

- c. Doors: The operable door portion that is exposed to an explosive threat shall consist of heavy-gauge (14 gauge or greater) metal and debris-mitigating materials (e.g., laminated glass adhered with structural silicone). The stationary frame shall be designed to develop the tributary blast load reaction forces, for the design blast load. Calculations or explosive testing results of identical systems shall demonstrate that the frame components are capable of resisting the specified tributary blast loads without failure.
- d. Nonglazed façade systems: Design components using ductile materials to withstand the specified blast load and transfer reaction forces back to the building structure without failure. Refer to PDC-TR 06-08, Rev. 1 (Jan. 7, 2008), for appropriate response limits.

4.F STRUCTURAL SYSTEMS

1. Protective Structural Design

Protective structural design enables building occupants to evacuate the building safely and rapidly during an emergency, especially if part of the building is subject to a blast or otherwise damaged or destroyed. The goal is to avoid progressive collapse by designing a structure that will not collapse if one or more structural members are damaged, fail, or are destroyed. This threat-independent approach is intended to assure redundant structural design.

- a. If the risk assessment specifies an exterior vehicle explosive threat or a hand-carried package threat (and associated magnitudes), the structural members that may be exposed to blast loading must also be designed to provide the specified performance for loading up to both (1) the blast load defined by the project-specific risk assessment and (2) the blast load defined within this guidance document (see section 4.E.13.b).
- b. Primary structural members that may be exposed to blast loading shall be designed to resist their tributary loads either by remaining elastic or through the formation of a ductile failure mechanism. If the member is designed to remain elastic under the specified blast load, the capacity of nonductile modes shall include a 1.5 factor of safety for the calculated force / moment demands. Redundant load paths shall be provided where the governing limit state is still found to be nonductile. Secondary structural members may sustain a localized breach in response to near-contact detonations; however, the extent of damage shall be limited to the structural bay in proximity to the event and shall not precipitate a disproportionate collapse.
- c. Negative phase blast loading effects shall be considered when rebound is a design consideration under blast loading. Negative phase blast loading shall be determined assuming the charge size defined in the project-specific risk assessment and the analytical methods defined in UFC 3-340-02.

2. Guidelines for Improved Structural Performance

The following general guidelines shall be followed to improve structural performance in the event of an explosion.

- a. Avoid overhangs with occupied space above.
- b. Provide structural redundancy and alternative load paths to mitigate the potential for catastrophic failure stemming from blast loads.
- c. Minimize horizontal and vertical structural irregularities.

DIVISION ONE: DESIGN CRITERIA

- 1 General Principles
- 2 Courthouse Organization
- 3 Site Design

4 COURTHOUSE SECURITY

- 4.A Objectives
- 4.B Design, Technology, and Operations
- 4.C Factors Affecting Security Levels
- 4.D Risk Assessment Procedures
- 4.E Physical Security Planning Criteria
- 4.F Structural Systems
- 4.G Mechanical, Electrical, and Fire Protection Systems
- 4.H Electronic Security Planning Criteria
- 4.I Electronic Security Systems
- 4.J Bullet-Resistant Glazing and Panels

- 5 Court Set
- 6 Jury Facilities and Court Administration
- 7 Special Services
- 8 In-Custody Defendant Receiving, Holding, and Transport
- 9 Public Spaces
- 10 Building Support Services

- d. Prevent a single point of failure of the building structure by avoiding large transfer girders or locating them away from areas that may be exposed to blast loading.
- e. Select a ductile structural system. Preferred structural systems include moment frame steel structures, steel frames with shear walls, braced steel frames, and reinforced concrete beam and slab systems with ductile detailing.
- f. Design structures greater than two stories tall to resist progressive collapse using the alternate-path method, which requires the structure to withstand the threat-independent removal of any first-floor exterior column, one at a time, or one bay width of exterior load-bearing walls, one at a time, without precipitating a disproportionate extent of damage. Give consideration to ductile moment-resisting frame lateral systems at the exterior of the building. Ensure that alternate-path analysis methods for demonstrating a structure's resistance to progressive collapse conform to UFC 4-023-03, Design of Buildings to Resist Progressive Collapse. Remove columns spaced closer than 30 percent of the largest bay dimension in the same alternate-path analysis.
- g. Assess structural members that may be exposed to blast loading for both direct blast loading and the effects of rebound as specified in table 4.2. Performance requirements shall conform to a medium level of protection as described in PDC-TR 06-08 Rev. 1, "Single Degree of Freedom Structural Response Limits for Antiterrorism Design," unless noted otherwise in table 4.2.
- h. Design and detail all flexural elements, their connections, and their splices such that no brittle failure mode limits the capacity of the section. Unless the element is designed to remain elastic in response to blast loading, ductile failure modes shall be the governing failure mode for flexural elements and their connections and splices. If the elements are designed to resist the blast loads elastically, the design of nonductile modes shall include a 1.5 factor of safety on the calculated forces or moment demand on the member.
- i. Design primary structural member connections to ensure the capacity of the connection is governed by a ductile failure mode. This requirement can be met by including a 1.5 factor of safety on the design of nonductile modes and ensuring that a ductile failure mode is found to be the governing limit state.
- j. Harden floor systems separating high-risk areas and occupied court areas to withstand the effects of the specified explosive, as per the risk assessment, located within an adjacent structural bay. Design floor slabs for upward forces (direct blast loading for slabs above high-risk areas and rebound loading for slabs below high-risk areas). The floor slab reinforcement in both the top and bottom mat shall be continuous and symmetric.
- k. Design structural columns in high-risk areas to resist the specified explosive, as per the risk assessment, located 3' away.
- l. Design wall elements that may be exposed to blast loading as one-way systems that span from floor to floor and do not attach them to columns.
- m. Concrete masonry unit (CMU) walls that may be exposed to blast loading shall be fully grouted and reinforced, with connections designed to allow full development of capacity at the supports.

Table 4.2 Summary of Structural System Performance Requirements

Component *	Component Damage Limit†	Design for Rebound?
Primary Structural Component (e.g., load-bearing walls, columns, girders)	Superficial	Yes‡
Secondary Structural Component (e.g., non-load-bearing masonry walls)	Moderate	Yes‡
Nonstructural Component (e.g., partitions, furniture, equipment, light fixtures)	Moderate	Only if required by project-specific requirements§
Non-Load-Bearing Interior Enclosure Walls	Heavy	Only if required by project-specific requirements

* Component descriptions can be found in table 2-3 of PDC-TR 06-08 Rev. 1.

† The CTCFS generally requires that the performance of structural members conform to a medium level of protection (see section 4.F.2.g). For this level of protection, PDC-TR 06-08 Rev.1 assigns a superficial damage limit to primary structural components and a moderate damage limit to secondary and nonstructural components. The use of a heavy damage limit for non-load-bearing interior enclosure walls is permitted by this guidance document in select instances, as described in sections 4.E.4., 4.E.9.h, and 4.E.11.d.

‡ The CTCFS generally requires that structural members subject to blast loads are evaluated for the effects of rebound (see section 4.F.2.g).

§ Although the damage limit is set to moderate to minimize hazards to occupants and follow the guidance of PDC-TR 06-08 Rev.1, assessment for rebound is required only if necessary per project-specific guidelines because most nonstructural components are generally symmetric and symmetrically anchored.

|| Heavy damage corresponds with a low level of protection. Since non-load-bearing interior enclosure walls are treated as sacrificial within this guidance document, the design for rebound is required only if necessary per project-specific guidelines.

4.G MECHANICAL, ELECTRICAL, AND FIRE PROTECTION SYSTEMS

Mechanical, electrical, and fire protection systems are critical security elements that must remain functional until all building occupants are able to evacuate safely and completely during an emergency.

Critical systems include fire protection, air-handling systems to evacuate smoke and positively pressurize egress stairs and vestibules, emergency communication systems, emergency lighting (especially at means of egress), and emergency power to ensure that these systems are functional in the event of a power outage.

- a. Locate critical utilities as far as possible from high-risk areas. Do not install utilities within 25' of public parking areas, an unscreened lobby, loading docks, and mailrooms. Stack critical areas and their supporting utilities.
- b. Locate power supply transformers and emergency generators away from high-risk areas—below grade, where possible, for best protection. If exterior transformers are required, locate them in an enclosure or fenced area with security locks, emergency lighting, and alarms.

**DIVISION ONE:
DESIGN CRITERIA**

- 1 General Principles
- 2 Courthouse Organization
- 3 Site Design

**4 COURTHOUSE
SECURITY**

- 4.A Objectives
- 4.B Design, Technology, and Operations
- 4.C Factors Affecting Security Levels
- 4.D Risk Assessment Procedures
- 4.E Physical Security Planning Criteria
- 4.F Structural Systems
- 4.G Mechanical, Electrical, and Fire Protection Systems
- 4.H Electronic Security Planning Criteria
- 4.I Electronic Security Systems
- 4.J Bullet-Resistant Glazing and Panels

- 5 Court Set
- 6 Jury Facilities and Court Administration
- 7 Special Services
- 8 In-Custody Defendant Receiving, Holding, and Transport
- 9 Public Spaces
- 10 Building Support Services

Refer to table 4.4 for security requirements by area and space type and the Judicial Council's *Security Systems Design Criteria Guide* for specific information regarding security systems requirements.

Electronic security systems shall be coordinated with building systems and reflect the evolving needs of the facility.

- Locate properly vented emergency generators at least 50' from the primary electrical source. Buildings should not intake exhaust fumes from generators. If emergency generators are located adjacent to high-risk areas, harden the intermediate floor and wall systems.
- c. Avoid routing critical utilities next to parking areas. If this cannot be avoided, encase them in concrete.
- d. To mitigate a chemical or biological attack within the building, locate air intakes at least 48' above grade or as high as practical. If air intakes are placed on the roof, secure all roof access points.
- e. Protect critical utilities, including service entrances.
- f. Locate main and backup systems as far apart from each other as possible, a minimum of 50'.
- g. If feasible, isolate the mailroom heating, ventilation, and air-conditioning (HVAC) zone to prevent circulation into the main building. Provide a system to purge mailroom in case of biochemical contamination.
- h. Evaluate required redundancy of critical systems. Refer to the individual sections for evaluation requirements. Where redundancy is provided for security purposes, place backup systems and distribution as far from primary systems as possible.
- i. Ensure adequate HVAC for heating load in detention control during unoccupied building mode.

4.H ELECTRONIC SECURITY PLANNING CRITERIA

Best practices for electronic security planning are described in this section. Table 4.4 lists the electronic security elements that are mandatory for all court buildings and those that may be required or modified by the project-specific risk assessment.

Detailed product requirements and information are contained in the Judicial Council's *Security Systems Design Criteria Guide*, which is shared with the design team at the start of a new courthouse project.

1. Site Security

- a. Use vehicle entry and exit gates and gate barrier arms at secure driveway entrances and exits.
- b. Provide video surveillance of all secure driveway areas and general coverage of public circulation areas. Coordinate with landscape design to ensure that camera sightlines are unobstructed. Refer to chapter 3, Site Design.
- c. At secure driveway entry vehicle gates, provide pedestals that accommodate the vehicle heights anticipated. Pedestal heads must support a card reader and, where applicable, camera and intercom station. Where in-custody transport vehicles share use of the secure driveway, pedestal heads must also support a detention intercom substation.
- d. In addition to pedestal-mounted card readers, provide a long-range reader at the secure vehicle gate entry lane to allow operation of the entry gate by judges and other designated personnel from within the safety of their vehicles using a windshield-mount access card signal booster or similar device.
- e. Provide alarm monitoring and video surveillance of pedestrian gates.
- f. At secure parking entries and exits, provide video surveillance, hands-free telephones, and card access control of vehicle gates and gate barrier arms.

2. Building Envelope

- a. Provide video surveillance of building exterior.
- b. Provide video surveillance, door position monitoring, and local alarm sounders at all operable building entry and exit points.
- c. Control after-hours access through designated perimeter doors with card readers. Provide, at perimeter doors, the minimum number of card readers that will facilitate operations.
- d. Provide intrusion alarms to monitor perimeter doors and sensitive areas after hours as required by the risk assessment.

3. Lobby, Circulation, and Waiting Areas

- a. Provide video surveillance, duress alarms, magnetometer, and package weapons scanners at screening lanes.
- b. Provide barrier turnstiles at exit lanes in line with the screening lanes to restrict access to the secure area from the exit lane, while maintaining throughput to satisfy exiting requirements.
- c. Provide video surveillance of lobby, circulation, and waiting areas.
- d. Provide alarm monitoring, local alarms, and video surveillance at doors separating not secure from secure, public from private, public from detention, and private from detention spaces. Provide card readers at designated security separation doors only where needed to facilitate operations.
- e. Doors that are used strictly for emergency egress purposes and that separate areas with differing security levels shall have video surveillance, be monitored for alarms, and have local alarm sounders.

4. Private Circulation and Waiting Areas

- a. Provide alarm monitoring, local alarms, and video surveillance at doors separating public from private and private from detention spaces. Provide card readers at designated security separation doors only where needed to facilitate operations.
- b. Emergency egress doors separating areas with differing security levels shall have video surveillance, alarm monitoring, and local alarm sounders.
- c. Exiting should always be from a higher security area to a lower security area. The public should not exit through a private corridor, except in cases of emergency.

5. Courtrooms

- a. Provide silent duress alarm buttons for judge, CSO, and clerk positions.
- b. Provide video surveillance of the courtroom, including well area, public seating, and where applicable, door-to-court holding.
- c. Control the public entry door into the courtroom using a card reader with integral keypad. Presentation of a card at the reader will momentarily unlock the doors to provide access to authorized persons when court is not in session. Each use of a card at the reader will activate the courtroom entry door to unlock the door while court is in session or lock the door to secure the courtroom when not in session. Refer to 5.D, Courtroom Components, for more information on courtroom doors.

DIVISION ONE: DESIGN CRITERIA

- 1 General Principles
- 2 Courthouse Organization
- 3 Site Design

4 COURTHOUSE SECURITY

- 4.A Objectives
- 4.B Design, Technology, and Operations
- 4.C Factors Affecting Security Levels
- 4.D Risk Assessment Procedures
- 4.E Physical Security Planning Criteria
- 4.F Structural Systems
- 4.G Mechanical, Electrical, and Fire Protection Systems
- 4.H Electronic Security Planning Criteria
- 4.I Electronic Security Systems
- 4.J Bullet-Resistant Glazing and Panels

- 5 Court Set
- 6 Jury Facilities and Court Administration
- 7 Special Services
- 8 In-Custody Defendant Receiving, Holding, and Transport
- 9 Public Spaces
- 10 Building Support Services

- d. Card access control from the courtroom to the private corridor at the witness stand or jury egress door is discouraged; however, it may be allowed on a case-by-case basis. Card access control of the judge's door behind the bench is not allowed.

6. Chambers

- a. Provide silent duress alarm buttons at the judges' desks.
- b. Provide secure access at judges' chambers doors to limit entry to authorized personnel.

7. Jury Deliberation Rooms

Provide wall-mounted silent duress alarm buttons in jury deliberation rooms. Locate duress buttons in a readily accessible area, situated to minimize inadvertent activation.

8. Public Transaction Counters

- a. Each public transaction counter position shall have a duress alarm button.
- b. Provide overall video surveillance of the public queuing and walk-up areas. If cameras are located behind the transaction counters, they should capture images of customers only, not staff.
- c. Provide an active full-duplex audio communication system at outdoor and unsecured public transaction counters. The communication system must have an on/off switch allowing staff to enable or disable communications.

9. Family Court Services Mediator Offices

Provide silent duress alarm buttons in mediator offices and video surveillance outside offices in the adjacent corridors.

10. Child Waiting Areas

- a. Provide silent duress alarm buttons and video surveillance inside child waiting areas. Camera coverage should include interior and exterior corridors by the child waiting area door in addition to the main child waiting area.
- b. A door intercom, remote door release, and local alarm annunciation system should be considered at child waiting areas with doors and interior circulation that are out of view of the staffed position. Local alarm annunciation must notify staff that a child has entered an out-of-view area or that someone has entered the child waiting area without permission. The staff person shall have the ability to arm and disarm local alarm annunciation as needed.

11. Current Case File Storage Areas

- a. Provide silent duress alarm buttons at staffed positions in public records viewing areas.
- b. Where public records rooms are not staffed, provide remote door release from secure staffed positions that are within view of the door.
- c. Provide video surveillance of all public viewing areas to create a record of files in custody of the public.

12. Evidence and Exhibit Storage Rooms

- a. Limit access to authorized personnel via card access control at the door. Provide two-factor authentication (card plus PIN) access control for entry into the evidence storage room using a card reader with integral keypad to prevent lost or stolen access cards from being used by unauthorized persons to enter evidence storage.

- b. Provide video surveillance and recording of all who enter and exit the evidence storage room.

13. Loading Dock, Receiving, and Mailroom

- a. Use card readers at key operational doors to facilitate loading dock and mailroom operations.
- b. Provide video surveillance of loading dock and receiving areas, and monitor doors for intrusion.
- c. Provide video surveillance and silent duress alarm button in the mailroom. Provide telephone outside receiving door to facilitate communication with delivery drivers when loading dock and mailroom are closed.
- d. Where required by the risk assessment, provide package weapons scanner in the mailroom. Where a package weapons scanner is not required by the risk assessment and not provided, all incoming packages delivered shall go through lobby security screening or another package screening process consistent with the court security operations plan.

14. Security Operations Center

- a. The building SOC may duplicate functions of or combine functions with the detention/holding control room. Chapter 8, In-Custody Defendant Receiving, Holding, and Transport, describes systems that may require backup operation in the SOC and provides information about detention and holding control rooms.
- b. Detention cameras monitored outside the detention area must not be viewable by the public at any time.
- c. Use modular workstation furniture in the SOC that is ergonomic and does not obstruct visibility of the lobby and screening area.
- d. Fire control centers, required with high-rise life-safety systems, shall remain separate from the security operations center. Locate a fire alarm annunciator in the SOC to provide security personnel with immediate fire alarm event information that affects security of the facility. Refer to chapter 20, Fire Protection Criteria, for specific fire alarm system criteria.

15. Security Equipment Location

- a. Locate electronic security headend equipment—including computers, storage, interface equipment, and the like—in the building main distribution frame (MDF) room.
- b. Locate monitoring and control computers, monitors, annunciators, and related equipment in the security operations center or other designated area if an SOC is not required.
- c. House security headend equipment in MDF or intermediate distribution frame (IDF) rooms in enclosed and lockable equipment racks and/or wall cabinets. Coordinate ample rack and wall space plus 25 percent future security equipment capacity. Coordinate rack and wall space requirements with the design of the MDF and IDF rooms. Refer to chapter 17, Network and Communication Systems, for specific telecommunications criteria.
- d. Electronic security system headend equipment must be network based and be provided with network connectivity and an uninterruptible power source.

**DIVISION ONE:
DESIGN CRITERIA**

- 1 General Principles
- 2 Courthouse Organization
- 3 Site Design

**4 COURTHOUSE
SECURITY**

- 4.A Objectives
- 4.B Design, Technology, and Operations
- 4.C Factors Affecting Security Levels
- 4.D Risk Assessment Procedures
- 4.E Physical Security Planning Criteria
- 4.F Structural Systems
- 4.G Mechanical, Electrical, and Fire Protection Systems
- 4.H Electronic Security Planning Criteria
- 4.I Electronic Security Systems
- 4.J Bullet-Resistant Glazing and Panels

- 5 Court Set
- 6 Jury Facilities and Court Administration
- 7 Special Services
- 8 In-Custody Defendant Receiving, Holding, and Transport
- 9 Public Spaces
- 10 Building Support Services

Security Electrical Systems

- Card access control
- Video surveillance
- Duress alarm
- Intrusion detection
- Turnstiles
- Weapons screening
- Secure driveway and parking controls
- Cable routing

- e. Point-to-point wiring is permitted in MDF and IDF rooms and from MDF or IDF rooms to field devices located on the same floor.
- f. Communication between floors must be over the court network using a virtual local area network. Point-to-point wiring between floors is not permitted.
- g. Detail detention equipment and monitor layout and equipment arms for organized and efficient layout.

4.1 ELECTRONIC SECURITY SYSTEMS

Security systems shall be integrated and communicate with each other via the court's local area network. Security electronics systems shall include the features described below. For additional details, refer to the latest draft of the Judicial Council Emergency Planning and Security Coordination unit's *Security Systems Design Criteria Guide*.

1. Card Access Control

The card access control system is the primary means of monitoring security events, controlling card access points, and logging and reporting activity.

- a. Provide monitoring and control of the secure driveway vehicle gates and doors, vehicle gate barrier arms, building perimeter protection, and separation between public, private, detention, and other critical areas.
- b. Design card access control measures to restrict access from a lower security area to a higher security area and where the measures will substantially benefit operations and minimize issuance of keys. Provide free egress in the reverse direction using a request-to-exit (REX) switch in the door hardware and a REX push button or motion sensor. Except where otherwise required by the type of door hardware, REX devices shall not unlock doors; REX devices shall only bypass the door position sensors to allow egress without generating an alarm.
- c. When armed, doors, hatches, and other operable access points shall be monitored for forced entry.
- d. Monitor all card access control doors for forced door and propped door alarms.
- e. Monitoring and administration of the system shall be via client computers located in the SOC.
- f. Integrate the card access control system with the video surveillance system, duress alarm system, lobby exit lane turnstiles, and intrusion detection system to provide alarm monitoring and automated camera call-up of all events in view of a camera.
- g. Coordinate security system (SS) plans with door schedule and hardware specifications for door position switches and card readers.
- h. Confirm top or bottom orientation and voltage for door operators.

2. Video Surveillance

- a. Provide an Internet Protocol (IP)-based video surveillance system utilizing networked cameras, video servers, storage, and workstations. Coaxial cable is not acceptable, except in certain elevator applications. Refer to chapter 17, Network and Communication Systems, for network cable criteria.

- b. Provide high-resolution color cameras throughout the facility and high-definition color cameras in each courtroom with digital video recording and storage for all cameras and seven days of data retention. Exterior cameras must have day and night capability to provide a usable image in low-light conditions. The use of Pan-Tilt-Zoom (PTZ) cameras shall be minimized or avoided altogether.
- c. Cameras may be powered via Power over Ethernet or by Class 2 camera power supplies, provided they have a separate circuit breaker or fuse-protected output for each camera.
- d. Ensure that monitoring and control of the video surveillance system are at computer workstations located in the SOC and detention control room (DCR). Smaller facilities may combine the operations of the SOC and DCR.
- e. Locate cameras at a height that would not require the use of a lift to service and that is also out of reach.
- f. Integrate the video surveillance system with the card access control system, duress alarm system, detention control system, and vehicle gate control equipment to automatically call up cameras relevant to facility alarms, triggers, and system events requiring immediate assessment and response by security or law enforcement personnel. Refer to chapter 8, In-Custody Defendant Receiving, Holding, and Transport, for detention control system requirements.
- g. Clarify security camera structural backing requirements. Coordinate camera locations with exterior wall assemblies. Confirm that all exterior penetrations are weatherproofed. Review camera orientation virtually with court security provider. Confirm stair devices with Office of the State Fire Marshal. Recommend not installing cameras in security ceilings.

3. Duress Alarm

- a. Provide a wireless duress alarm system consisting of a controller, repeaters for larger facilities, and wireless duress buttons.
- b. Design the duress alarm system to communicate using a variety of methods, including a designated law enforcement radio frequency and the audible announcement of the location of the alarm. Coordinate the methods, including the exact frequency to be used, with the court and the court's designated law enforcement agency.
- c. Integrate the duress alarm system with the card access control and video surveillance systems via the court network to permit alarm notification and automatic camera call-up in the SOC or other designated security monitoring locations.
- d. Incorporate a NEMA 3R wet-rated button for all exterior-mounted duress alarms, such as those located in sally ports.

4. Intrusion Detection

- a. Where required by the risk assessment, provide intrusion detection at perimeter doors. Provide double-pole door position switches at doors being monitored by the access control and intrusion detection systems to isolate their inputs and minimize modifications to doors and frames.
- b. Locate arming stations at designated entry points. Keep the number of arm/disarm entry points to a minimum. Where the entry point is a public area, situate arming stations to minimize public access while remaining in plain sight of staff.
- c. Provide a card reader at each arming station, and interface the card access system with the intrusion detection system to allow arming and disarming by access card.

DIVISION ONE: DESIGN CRITERIA

- 1 General Principles
- 2 Courthouse Organization
- 3 Site Design

4 COURTHOUSE SECURITY

- 4.A Objectives
- 4.B Design, Technology, and Operations
- 4.C Factors Affecting Security Levels
- 4.D Risk Assessment Procedures
- 4.E Physical Security Planning Criteria
- 4.F Structural Systems
- 4.G Mechanical, Electrical, and Fire Protection Systems
- 4.H Electronic Security Planning Criteria
- 4.I Electronic Security Systems
- 4.J Bullet-Resistant Glazing and Panels

- 5 Court Set
- 6 Jury Facilities and Court Administration
- 7 Special Services
- 8 In-Custody Defendant Receiving, Holding, and Transport
- 9 Public Spaces
- 10 Building Support Services

5. Turnstiles

Monitor the lobby screening exit lane turnstiles for operational failures and attempts to enter the secure area via the exit lane. Operation of the lobby screening exit lane turnstiles by the security system is not required. Exit lanes shall have an 8' tall glass wall for visual surveillance.

6. Weapons Screening

- a. Provide X-ray scanners and Americans with Disabilities Act (ADA) compliant magnetometers in the lobby to screen persons and belongings for weapons before entering secure space.
- b. Design screening lanes to provide ample space for equipment, including current recommended spacing between magnetometers and X-ray scanners and between conveyers and tables, as well as clearance for ADA-compliant magnetometers.

7. Secure Driveway and Parking Controls

- a. Provide vehicle gates and gate barrier arms at secure driveways and at secure parking entrances to restrict public access.
- b. Provide vehicle gates and gate barrier arms at secure parking areas to restrict access from secure driveways.
- c. Ensure that vehicles cannot become trapped between gates, overhead doors, and gate barrier arms under any circumstances.

8. Cable Routing

- a. Route all security cabling in metallic conduit or raceway where cabling is run in walls and above hard ceilings. Above accessible ceilings, use cable tray where provided and J hooks elsewhere. Any security cable in outdoor locations, including within underground conduit, shall include a water blocking compound, and the jacket shall be outdoor rated for wet locations.
- b. Provide back boxes suitable for all field devices and terminations.
- c. Refer to chapter 15, Electrical Criteria, for specific conduit criteria.
- d. Refer to chapter 17, Network and Communication Systems, for specific network cable requirements.
- e. Installation of ceiling access doors in the detention cell ceilings is prohibited.

4.J BULLET-RESISTANT GLAZING AND PANELS

1. Exterior Windows

Where risk assessment stipulates bullet resistance, provide the following:

- Glazing: Glass-clad polycarbonate assembly. See chapter 11, Architectural Criteria.
- Panel in opening above or below glass: Bullet-resistant starch-oil woven roving ballistic-grade fiberglass panels to match the ballistic rating of the glazing.
- Threat level: Underwriters Laboratories' UL 752 Level 3, three shots or greater, as stipulated by risk assessment.

2. Clerk/Public Transaction Counter

- a. For counter outside the building weapons screening, provide the following:
 - Glazing: glass-clad polycarbonate assembly (see chapter 11).
 - Panel in opening above or below glass: bullet-resistant starch-oil woven ballistic-grade fiberglass panels to match the ballistic rating of the glazing.
 - Threat level: UL 752 Level 3, three shots and forced entry or greater, as stipulated by risk assessment.
- b. For counter within the building weapons screening, provide the following:
 - Laminated glass: Two glass layers with polyvinyl butyral (PVB) interlayer (thickness determined by calculation for glass size and supporting structure).
 - No bullet-resistant panels.
 - Not bullet or forced-entry resistant.

3. Judge/Clerk/Witness Courtroom Bench

For judge's bench, witness box, and courtroom clerk's work area, provide the following:

- Behind finish material: bullet-resistant starch-oil woven ballistic-grade fiberglass panels.
- Threat level: UL 752 Level 3, three shots or greater, as stipulated by risk assessment.

DIVISION ONE: DESIGN CRITERIA

- 1 General Principles
- 2 Courthouse Organization
- 3 Site Design

4 COURTHOUSE SECURITY

- 4.A Objectives
- 4.B Design, Technology, and Operations
- 4.C Factors Affecting Security Levels
- 4.D Risk Assessment Procedures
- 4.E Physical Security Planning Criteria
- 4.F Structural Systems
- 4.G Mechanical, Electrical, and Fire Protection Systems
- 4.H Electronic Security Planning Criteria
- 4.I Electronic Security Systems
- 4.J Bullet-Resistant Glazing and Panels

- 5 Court Set
- 6 Jury Facilities and Court Administration
- 7 Special Services
- 8 In-Custody Defendant Receiving, Holding, and Transport
- 9 Public Spaces
- 10 Building Support Services

Table 4.3 Notes**M:** Compliance Mandatory**RA:** As Determined by Risk Assessment**SR:** Strongly Recommended**Table 4.3 Security Standards**

	COMPLIANCE
Site Selection	
Maximize setback distance to street or adjacent buildings.	M
Locate building to minimize adjacency and configuration risks.	M
Provide setback distance other than that defined in 4.E, Physical Security Planning Criteria.	RA
Parking Security	
Restrict public parking locations in proximity to court building to satisfy setback requirements.	M
Restrict and control secure parking locations within defended perimeter.	M
Colocate parking garage and loading dock entries.	RA
Provide minimum 6" nonstructural architectural finish around interior columns in secure parking areas.	M
Provide video surveillance at parking entries and exits.	RA
Locate critical and occupied space at least 25' away from secure parking, or harden enclosure for screened vehicle threat (charge weight to be specified by RA).	RA
Harden interior structure in parking for screened vehicle threat (charge weight to be specified by RA).	RA
Site Security	
Employ CPTED principles.	M
Place trash receptacles and mailboxes outside the setback distance.	M
Illuminate site perimeters, walkways, and drives.	M
Restrict height of landscaping.	M
Protect utilities (gas, power, telephone, etc.) at entrance to site.	M
Provide video surveillance of site.	M
Provide antiram barriers to enforce required building setback distance (moving vehicle threat). RA to indicate extent of antiram perimeter required and level of antiram resistance.	RA
Building Layout	
Provide only one public entrance.	M
Provide a secure path between judges' parking and chambers.	M
Separate high-risk areas from occupied spaces, critical systems, utilities, and egress.	M
Colocate loading dock and mailroom toward the building exterior.	M
Courtrooms	
Provide silent duress alarm buttons for judge, CSO, and clerk.	M
Provide bullet-resistant panels within podium/bench for judge, CSO (depending on makeup of CSO station), clerk, and witness stand.	M
Provide video surveillance.	M
Provide bullet-resistant panels and glazing to counters accessible outside secure areas.	M
Minimize vision through windows with the line of sight from exterior into courtroom.	M
Provide bullet-resistant glazing.	RA

Table 4.3 continues on next page

Table 4.3 Security Standards *continued*

	COMPLIANCE
Judge’s Chambers	
Provide silent duress alarm buttons for judge and clerk.	M
Minimize vision through windows with the line of sight from exterior into chambers.	M
Provide bullet-resistant glazing up to height and/or story specified in RA.	M
Jury Deliberation Room	
Provide silent duress alarm buttons.	M
Minimize windows with the line of sight into jury deliberation room.	M
Payment Counter	
Provide silent duress alarm buttons.	M
Provide video surveillance.	M
Provide two-way audio communications.	M
Provide bullet-resistant panels and glazing to counters accessible outside security screening.	M
Court Clerk Offices	
Provide silent duress alarm buttons in private corridor adjacent to chambers.	M
Executive/Administrative Offices	
Provide silent duress alarm buttons	M
Family Court Services Mediator Offices	
Provide silent duress alarm buttons in offices.	M
Provide video surveillance outside offices in adjacent corridors.	M
Child Waiting Areas	
Provide silent duress alarm button at staffed position.	M
Provide video surveillance inside child waiting areas.	M
Provide video surveillance in corridor outside child waiting areas.	M
Lobby and Waiting Area	
Provide only one public entrance.	M
Eliminate potential areas of concealment in unscreened areas.	M
Provide duress alarms, magnetometer, and package weapons scanner at screening station.	M
Design lobby to accommodate direct visual surveillance by security.	M
Design lobby to allow increased levels of security.	M
Provide barriers between lobby and secure areas of building.	M
Physically isolate unscreened lobby area.	M
Provide video surveillance of lobby and secure public circulation areas of building.	M
Provide minimum 6” nonstructural architectural finish around interior columns.	M
Harden interior structure in lobby for hand-carried satchel threat (charge weight to be specified by RA).	RA
Harden lobby enclosure for hand-carried satchel threat (charge weight to be specified by RA).	RA

Table 4.3 continues on next page

**DIVISION ONE:
DESIGN CRITERIA**

- 1 General Principles
- 2 Courthouse Organization
- 3 Site Design

**4 COURTHOUSE
SECURITY**

- 4.A Objectives
- 4.B Design, Technology, and Operations
- 4.C Factors Affecting Security Levels
- 4.D Risk Assessment Procedures
- 4.E Physical Security Planning Criteria
- 4.F Structural Systems
- 4.G Mechanical, Electrical, and Fire Protection Systems
- 4.H Electronic Security Planning Criteria
- 4.I Electronic Security Systems
- 4.J Bullet-Resistant Glazing and Panels

- 5 Court Set
- 6 Jury Facilities and Court Administration
- 7 Special Services
- 8 In-Custody Defendant Receiving, Holding, and Transport
- 9 Public Spaces
- 10 Building Support Services

Table 4.3 Notes**M:** Compliance Mandatory**RA:** As Determined by Risk Assessment**SR:** Strongly Recommended**Table 4.3 Security Standards** *continued*

	COMPLIANCE
Current Case File Storage Areas	
Locate within private circulation.	M
Provide silent duress alarms at staffed positions.	M
Provide card reader.	M
Provide video surveillance.	M
Provide dual authentication card reader with personal identification number (PIN).	RA
Provide remote door unlock.	RA
Evidence and Exhibit Storage Rooms	
Locate evidence room within private circulation.	M
Provide dual authentication card reader with PIN for evidence room.	M
Provide video surveillance of evidence room door.	M
Locate exhibit storage rooms within private circulation.	M
Provide hard ceilings in exhibit storage rooms and secure by lock and key.	M
Loading Dock and Mailroom	
Provide silent duress alarm button.	M
Provide video surveillance.	M
Provide space and driveway arrangement to permit manual screening of delivery trucks.	M
Provide minimum 6" nonstructural architectural finish around interior columns.	M
Physically isolate the loading dock and provide a means for venting gas pressures.	RA
Locate critical and occupied space at least 25' away from loading dock and mailroom, or harden enclosure for package threat (charge weight to be specified by RA).	RA
Harden interior structure in loading dock and mailroom for package threat (charge weight to be specified by RA).	RA
Provide package scanner in mailroom.	RA
Security Operations Center	
Use modular workstation furniture where an SOC is provided.	M
Provide SOC to operate and monitor electronic security systems.	RA
Duplicate functions of in-custody detention control room.	RA
Building Envelope	
Exterior doors shall be locked after hours.	M
Minimize or eliminate operable windows.	M
Limit windows at critical areas.	M
Provide laminated or tempered glass for debris mitigation.	M
Provide forced entry protection at the first floor (forced-entry rating to be specified by RA).	M
Provide video surveillance of building perimeter and all entrances.	M
Provide the minimum number of card readers at perimeter doors that will facilitate operations.	M
Monitor exterior doors and glass with an intrusion alarm system.	RA
Provide blast-, bullet-, or forced entry-resistant façade to meet performance requirements.	RA

Table 4.3 continues on next page

Table 4.3 Security Standards *continued*

	COMPLIANCE
Structural Systems	
Design structures greater than two stories tall to resist progressive collapse using the alternate path method.	M
Fully grout and reinforce exterior concrete masonry unit walls as well as those around high-risk areas with an identified explosive threat, with connections designed to allow full development of capacity at the supports.	M
Minimize floor-to-floor heights.	SR
Minimize column bay spacing.	SR
Avoid overhangs with occupied space above.	SR
Limit or avoid large transfer girders.	SR
Provide redundancy and alternative load paths.	SR
Use ductile structural systems.	SR
Design structural members to satisfy performance requirements if explosive threats are specified, and detail the connections to prevent brittle modes of failure.	RA
Harden floor and/or walls to resist specified threat in high-risk areas.	RA
Use circular columns with spiral reinforcing for concrete buildings; encase columns in concrete for steel buildings.	RA
Design structural columns to resist specified explosive threat located 3' away.	RA
Use one-way wall elements spanning from floor to floor.	RA
Mechanical, Electrical, and Fire Protection Systems	
Locate critical utilities as far as possible from high-risk areas.	M
Locate emergency generators at least 50' from the primary electrical source.	M
Avoid routing critical utilities next to parking areas.	M
Protect air intakes.	M
Protect critical utilities and service entrances.	M
Locate main and backup systems as far apart from each other as possible, a minimum of 50'.	RA
Isolate mailroom HVAC zone.	RA
Provide mailroom purging system.	RA
Provide redundancy of critical systems.	RA
Electronic Security Systems	
Provide access control between public, private, and detention areas.	M
Provide electronic building perimeter protection.	M
Provide recording of all cameras.	M
Provide monitoring of intrusions and duress alarms.	M
Integrate security subsystems for automated responses to system events.	M
Security subsystems shall utilize court network infrastructure for intersystem communications and communications between MDF/IDF rooms.	M
Coordinate current and future infrastructure and control systems.	M

**DIVISION ONE:
DESIGN CRITERIA**

- 1 General Principles
- 2 Courthouse Organization
- 3 Site Design

**4 COURTHOUSE
SECURITY**

- 4.A Objectives
- 4.B Design, Technology, and Operations
- 4.C Factors Affecting Security Levels
- 4.D Risk Assessment Procedures
- 4.E Physical Security Planning Criteria
- 4.F Structural Systems
- 4.G Mechanical, Electrical, and Fire Protection Systems
- 4.H Electronic Security Planning Criteria
- 4.I Electronic Security Systems
- 4.J Bullet-Resistant Glazing and Panels

- 5 Court Set
- 6 Jury Facilities and Court Administration
- 7 Special Services
- 8 In-Custody Defendant Receiving, Holding, and Transport
- 9 Public Spaces
- 10 Building Support Services

Table 4.4 Notes

R: Required

R1: Required as Applicable

D: Discretionary

Table 4.4 Electronic Security Standards by Space Type

	Card Access	Card + PIN Access	Card Access—Long Range	Door/Gate Position Monitoring	Local Alarm	Video Surveillance	X-ray Screening	Magnetometer	Exit Control/Turnstile	Duress Alarm	Voice Communications at Door/Window	Vehicle Door/Gate	Gate Barrier Arms	Door Intrusion Detection	Glass Break Detection	Intrusion System Keypad	Security Monitoring and Control Workstation	Headend Equipment
Site																		
Secure Driveway Entrance	R		R	R		R					R	R	R					
Secure Driveway						R												
Secure Parking Vehicle Entrance	R		R	R		R						R	R					
In-Custody Driveway Entrance	R		R	R		R					R	R	R					
In-Custody Driveway						R												
Parking Driveway Entrance						R												
Utility Equipment & Access						R												
Generator and Fuel Storage						R												
Building Perimeter																		
Main Entrance Doors	R			R	R1	R					P			R1	R1	R1		
Perimeter Doors	R1			R	R1	R					R1			R1	R1	R1		
Emergency Egress Doors				R	R	R								R1	R1			
Operable Windows, Hatches, Vents				R1		R1								R1	R1			
Secure Parking Area						R				R								
Secure Parking Building Entrance	R					R				R				R1	R1	R1		
Exterior Utility & MEP Rooms				R		R								R1				
Loading Dock	R1			R		R					R			R1				
Receiving	R			R		R	R1				R			R1				
Building Exterior						R												

Table 4.4 continues on next page

Table 4.4 Electronic Security Standards by Space Type *continued*

	Card Access	Card + PIN Access	Card Access—Long Range	Door/Gate Position Monitoring	Local Alarm	Video Surveillance	X-ray Screening	Magnetometer	Exit Control/Turnstile	Duress Alarm	Voice Communications at Door/Window	Vehicle Door/Gate	Gate Barrier Arms	Door Intrusion Detection	Glass Break Detection	Intrusion System Keypad	Security Monitoring and Control Workstation	Headend Equipment
Interior Public Circulation																		
Public Queuing Area						R												
Weapons Screening Station						R	R	R	R	R								
Information Kiosk or Counter						R				R								
Courtroom Public Waiting Area						R												
Interior Private Circulation																		
Public to Private Area Doors	R			R	R	R												
Court Set																		
Courtroom Entry Door		R		R		R												
Courtroom Jury Door	R1			R	R1													
Courtroom Bench Door	R1			R1	R1													
Courtroom Well and Spectator Area						R												
Judge's Bench											R							
Clerk's Stations											R							
Court Security Officer's Station											R							
Courtroom Holding Door						R												

**DIVISION ONE:
DESIGN CRITERIA**

- 1 General Principles
- 2 Courthouse Organization
- 3 Site Design

4 COURTHOUSE SECURITY

- 4.A Objectives
- 4.B Design, Technology, and Operations
- 4.C Factors Affecting Security Levels
- 4.D Risk Assessment Procedures
- 4.E Physical Security Planning Criteria
- 4.F Structural Systems
- 4.G Mechanical, Electrical, and Fire Protection Systems
- 4.H Electronic Security Planning Criteria
- 4.I Electronic Security Systems
- 4.J Bullet-Resistant Glazing and Panels

- 5 Court Set
- 6 Jury Facilities and Court Administration
- 7 Special Services
- 8 In-Custody Defendant Receiving, Holding, and Transport
- 9 Public Spaces
- 10 Building Support Services

Table 4.4 continues on next page

Table 4.4 Notes

- R: Required
- R1: Required as Applicable
- D: Discretionary

Table 4.4 Electronic Security Standards by Space Type *continued*

	Card Access	Card + PIN Access	Card Access—Long Range	Door/Gate Position Monitoring	Local Alarm	Video Surveillance	X-ray Screening	Magnetometer	Exit Control/Turnstile	Duress Alarm	Voice Communications at Door/Window	Vehicle Door/Gate	Gate Barrier Arms	Door Intrusion Detection	Glass Break Detection	Intrusion System Keypad	Security Monitoring and Control Workstation	Headend Equipment
Court Support																		
Chambers	D			D						R								
Court Reporter's Room	D			D														
Jury Deliberation Room	D			D						R								
Entry Vestibule		R		R		R												
Law Enforcement Waiting Area																		
Courtroom Exhibit Storage	R			R														
Evidence Storage		R		R	R	R												
Jury Assembly Facilities																		
Entry/Queuing						R												
Reception/Registration	R			R						R								
Jury Assembly	R1			R1	R1	R												
Court Administration																		
Public Counter Queuing						R												
Public Transaction Counter										R	R							
Records Viewing Area	R1			R1		R				R1								
Training Room																		
Active Records Storage	R			R														
Inactive Records Storage	R1			R1														

Table 4.4 continues on next page

Table 4.4 Electronic Security Standards by Space Type *continued*

	Card Access	Card + PIN Access	Card Access—Long Range	Door/Gate Position Monitoring	Local Alarm	Video Surveillance	X-ray Screening	Magnetometer	Exit Control/Turnstile	Duress Alarm	Voice Communications at Door/Window	Vehicle Door/Gate	Gate Barrier Arms	Door Intrusion Detection	Glass Break Detection	Intrusion System Keypad	Security Monitoring and Control Workstation	Headend Equipment
Private Office																		
Executive/Director										R1								
Mediator										R1								
Family Law / Self-Help Center																		
Waiting Area						R												
Reception/Sign-in						R												
Orientation Room	R1			R1														
Workshop	R1			R1														
Mediation Room										R								
Child Waiting Area	R			R		R				R								
Alternative Dispute Resolution																		
Reception/Waiting Area										R								
Mediation/Arbitration Rooms										R								
Related Justice Agency Spaces																		
Multipurpose Rooms	R1			R1		R1												
Attorney Convenience Center	R1			R1		R1												

**DIVISION ONE:
DESIGN CRITERIA**

- 1 General Principles
- 2 Courthouse Organization
- 3 Site Design

4 COURTHOUSE SECURITY

- 4.A Objectives
- 4.B Design, Technology, and Operations
- 4.C Factors Affecting Security Levels
- 4.D Risk Assessment Procedures
- 4.E Physical Security Planning Criteria
- 4.F Structural Systems
- 4.G Mechanical, Electrical, and Fire Protection Systems
- 4.H Electronic Security Planning Criteria
- 4.I Electronic Security Systems
- 4.J Bullet-Resistant Glazing and Panels

- 5 Court Set
- 6 Jury Facilities and Court Administration
- 7 Special Services
- 8 In-Custody Defendant Receiving, Holding, and Transport
- 9 Public Spaces
- 10 Building Support Services

Table 4.4 continues on next page

Table 4.4 Notes

- R: Required
- R1: Required as Applicable
- D: Discretionary

Table 4.4 Electronic Security Standards by Space Type *continued*

	Card Access	Card + PIN Access	Card Access—Long Range	Door/Gate Position Monitoring	Local Alarm	Video Surveillance	X-ray Screening	Magnetometer	Exit Control/Turnstile	Duress Alarm	Voice Communications at Door/Window	Vehicle Door/Gate	Gate Barrier Arms	Door Intrusion Detection	Glass Break Detection	Intrusion System Keypad	Security Monitoring and Control Workstation	Headend Equipment
Building Support Services																		
Security Operations Center	R			R														R
Loading Dock	R			R		R												
Trash and Recycling Area						R												
Media Area						R												
Mailroom						R	R1			R								
Maintenance Shop	R			R														
Furniture/Equipment Storage	R1			R1														
Information Systems Workroom	R			R														
MDF and IDF Rooms	R			R														R
Telecommunications Storage Room	R1			R1														
Telecommunications Closet	R			R														
Electrical Room	R1			R1														
Electrical Closet	R1			R1														
Interior Media Space						R1												

5

DIVISION ONE: DESIGN CRITERIA

COURT SET

SECTION	TOPIC	PAGE
5.A	Objectives	5.2
5.B	Courtroom	5.3
5.C	Courtroom Accessibility	5.5
5.D	Courtroom Components	5.6
5.E	Courtroom Support Spaces	5.15

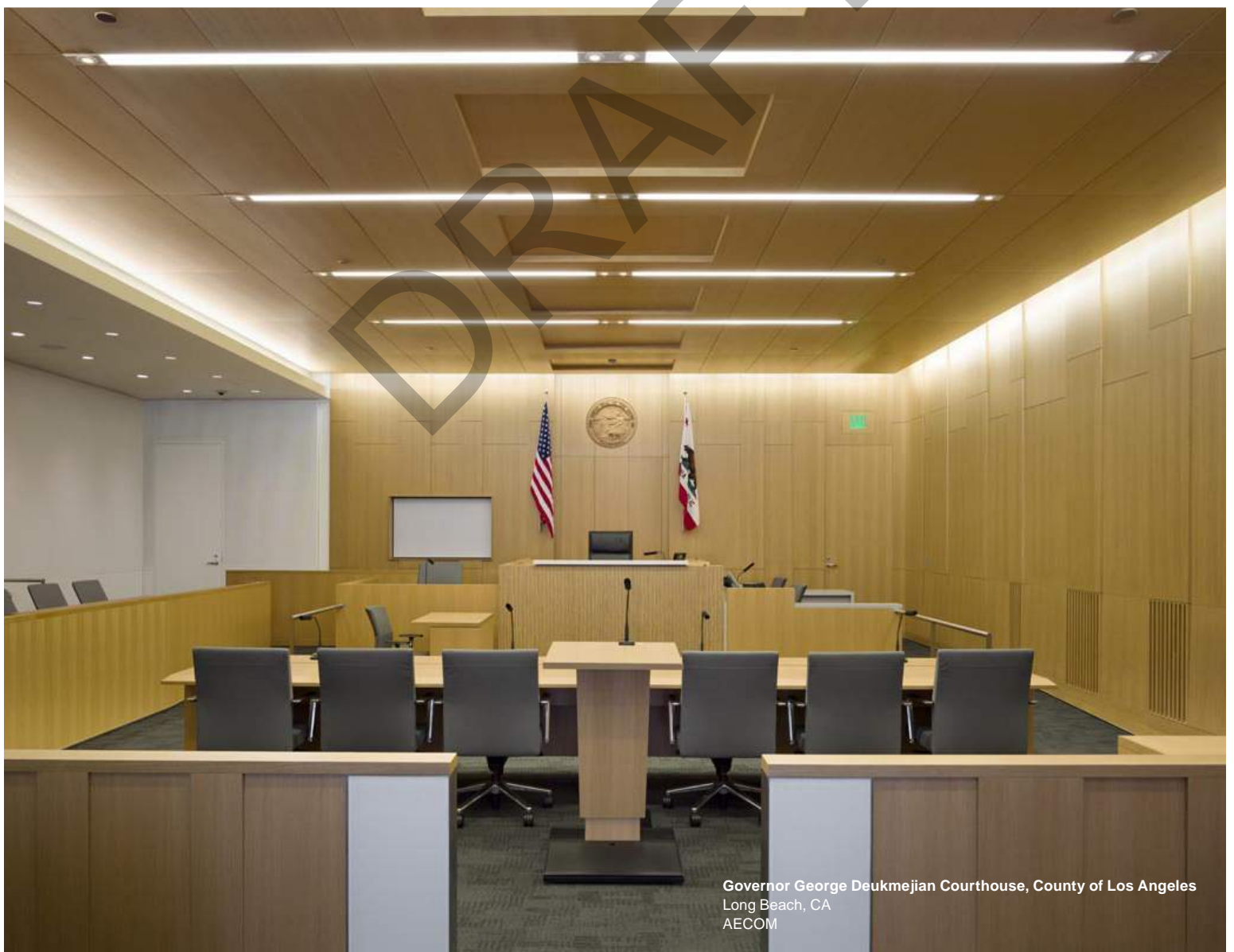

Governor George Deukmejian Courthouse, County of Los Angeles
Long Beach, CA
AECOM

The courtroom is the focal point of the judicial process, providing a formal setting for conducting the business of the court, and is the primary place where judicial officers, court staff, attorneys, and litigants or defendants interact.

REFER TO TOOL 2, CATALOG OF COURTROOM LAYOUTS FOR CALIFORNIA TRIAL COURTS, FOR APPLICATION IN THE DESIGN OF ALL FULLY OR PARTIALLY STATE-FUNDED NEW COURTHOUSES TO BE USED BY THE TRIAL COURTS.

THE COURTHOUSES ARE PRESUMPTIVELY REQUIRED TO USE TEMPLATES FOR LAYOUTS OF MULTIPURPOSE COURTROOMS AND HOLDING CORE.

THE EXAMPLES ARE INCLUDED AS REFERENCE ONLY, TO BE USED IN LIEU OF MOCKUPS.

A courtroom millwork finish mockup is required for medium and large projects before beginning casework manufacturing, to ensure the quality requirements of finish materials are satisfied.

For technical requirements, refer to chapter 15, Electrical Criteria; chapter 17, Network and Communication Systems; and chapter 18, Audiovisual Systems.

The court set includes courtrooms, judicial offices (subsequently referred to as chambers), chambers support space, jury deliberation rooms, witness waiting, attorney conference rooms, evidence storage, and equipment storage. A private corridor, with staff elevator and stairs, connects the chambers suites with staff offices and secure parking (see figure 5.1). Emergency egress for the private corridor should be separate from egress for the public corridor, but in some courthouses the private population may egress into the public circulation and then use the public egress stair. In courthouses where separate stairs are provided, private area stairs may be unsecured to allow staff intercommunication between floors, whereas public stairs should always be secure, allowing egress only. Specific space requirements are developed during the programming phase, consistent with area requirements described in chapter 2, Courthouse Organization.

5.A OBJECTIVES

The courtroom accommodates the judicial officer (judge, commissioner, or hearing officer), court clerk, reporter, court security officer (CSO), attorneys, witnesses, jury, and spectators. Special-purpose courtrooms may include some variation of these participants.

The design of each courtroom shall:

- Ensure that the participants in any proceeding are able to see and hear the witness, jury, judicial officer, court clerk, court reporter, and attorneys;
- Protect witnesses and jurors from intimidation;
- Provide reasonable confidentiality for attorneys, defendants, litigants, and judicial officers;

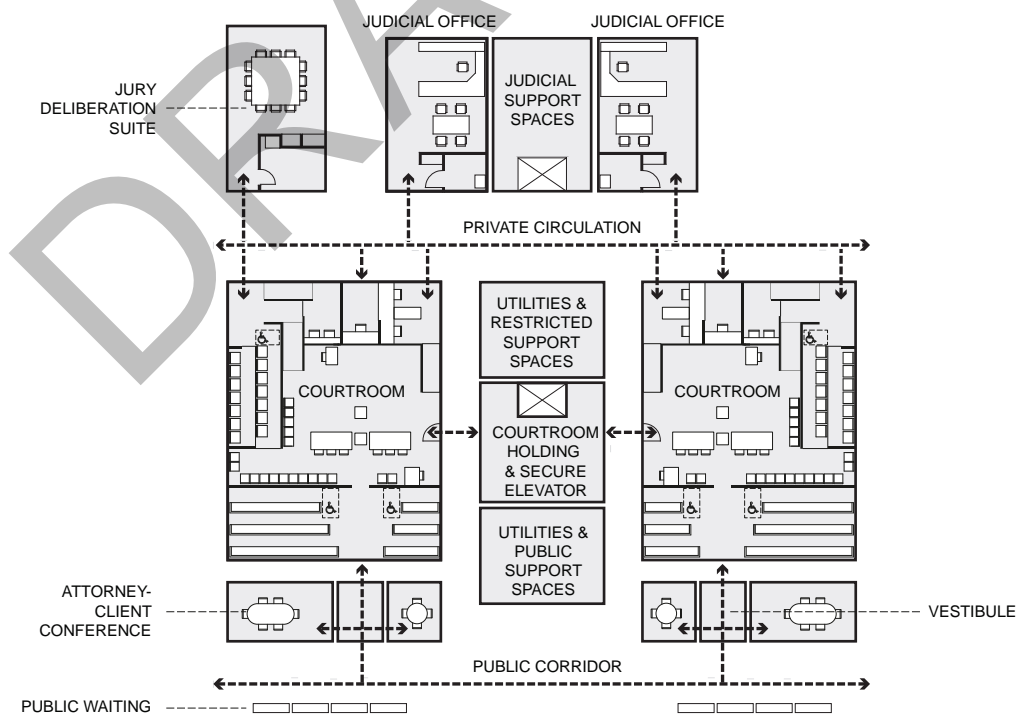

Note: For illustration only. Refer to tool 2, Catalog of Courtroom Layouts for California Trial Courts, for courtroom template plans.

Figure 5.1 Illustration of Typical Courtroom Floor Organization

- Provide full accessibility for persons with disabilities to the witness stand, jury box, spectator areas, judge’s bench, and clerk’s station;
- Provide security and safe emergency egress;
- Provide ease of assistance in emergency situations; and
- Provide spaces with sufficient flexibility to allow change in future court operations.

5.B COURTROOM

1. Basic Courtroom Types

This *Facilities Standards* document recognizes two types of courtrooms, multipurpose courtrooms and specialty courtrooms.

1.1 Multipurpose Courtrooms

The multipurpose courtroom is the typical trial courtroom in California, capable of accommodating every kind of court proceeding. It is sized and configured to support a variety of proceedings in different case types, including the array of criminal and civil pretrial calendars and proceedings, jury trials, and court trials. The use of multipurpose courtrooms maximizes a court’s capacity to accommodate its overall courtroom workload and to adjust its processes and calendar design, which are necessary because subject-matter caseloads change over time and changes in law place new demands on trial courts.

1.2 Specialty Courtrooms

Specially designed and sized courtrooms may be required in light of population size, caseload volumes, courthouse scale, and other considerations unique to a specific project. Specialty courtrooms can include multiple jury courtrooms, high-volume criminal arraignment/pretrial courtrooms equipped with secure high-volume in-custody docks (located adjacent to court holding facilities), high-volume traffic courtrooms, juvenile delinquency and dependency courtrooms, and mental health courtrooms, among others. Specialty courtrooms are by their nature not as flexible as multipurpose courtrooms for use in a variety of different case types and proceedings. Accordingly, specialty courtrooms should be considered only when the multipurpose courtroom cannot effectively and safely be used.

2. Initial Design Considerations

Tool 2, Catalog of Courtroom Layouts for California Trial Courts, is a collection of approved templates of multipurpose courtrooms that were developed based on—and tested against—designs used in constructed courthouse projects. These templates offer optimal sightlines throughout the courtroom, the capability to accommodate multiparty cases, additional space for chairs in front of the gallery, sufficient work area for two clerks, sufficient space in the witness box for an interpreter, sufficient working space for the bench officer, ease of access to the jury box, inclusion of an array of courtroom security solutions, adequate size and proportion of all working areas, adequate gallery size, the most effective and efficient overall use of space including a rectangular footprint, the positioning of counsel tables to ensure privacy from juror chair sightlines, and the highest-quality approaches to the various design considerations articulated in the balance of this chapter.

DIVISION ONE: DESIGN CRITERIA

- 1 General Principles
- 2 Courthouse Organization
- 3 Site Design
- 4 Courthouse Security

5 COURT SET

- 5.A Objectives
- 5.B Courtroom
- 5.C Courtroom Accessibility
- 5.D Courtroom Components
- 5.E Courtroom Support Spaces
- 6 Jury Facilities and Court Administration
- 7 Special Services
- 8 In-Custody Defendant Receiving, Holding, and Transport
- 9 Public Spaces
- 10 Building Support Services

The proposed inclusion of multipurpose courtrooms for a new construction project that does not adopt approved templates from tool 2, Catalog of Courtroom Layouts for California Trial Courts, will be presumed to be unsupported and—absent a showing that overcomes the presumption—will be disallowed.

Tool 2 also includes examples of courtroom floor plans of constructed California courthouses. The examples are similar to the template layouts and are included to enable design teams to compare design floor plans with built courtrooms and, if necessary, visit the courtrooms in lieu of constructing courtroom mockups. These floor plans include multipurpose and specialty courtroom designs.

The Catalog of Courtroom Layouts does not contain *templates* for specialty courtrooms.

For the number of courtroom requirements in a project, the program team and court should clearly identify any specialty courtroom needs during the programming phase because later identification in the design process can lead to compromised solutions.

THE PROPOSED INCLUSION OF MULTIPURPOSE COURTROOMS FOR A NEW CONSTRUCTION PROJECT THAT DOES NOT ADOPT APPROVED TEMPLATES FROM TOOL 2, CATALOG OF COURTROOM LAYOUTS FOR CALIFORNIA TRIAL COURTS, WILL BE PRESUMED TO BE UNSUPPORTABLE AND—ABSENT A SHOWING THAT OVERCOMES THE PRESUMPTION—WILL BE DISALLOWED.

This presumption does not apply to part-time satellite and specialty court facilities described in chapter 2, sections 2.C.7 and 2.C.8.

3. Courtroom Entries

All courtrooms, regardless of whether in-custody proceedings occur there, require three distinct points of entry:

- Public—for spectators, attorneys, parties, witnesses, and press—through a vestibule from the public corridor.
- Private—for judicial officers, jurors, court personnel, and designated court participants—through two doorways from a private court staff corridor.
- Detention—for in-custody defendants, detention officers, and CSOs—through a controlled, secure entry near the CSO’s station and defense attorney table from the detention (secure) circulation system.

4. Courtroom Adjacencies

- a. Locate courtrooms adjacent to court floor holding cells (or area reserved for the future addition of secure holding cells). In some instances, multipurpose courtrooms are used initially only for civil proceedings and do not require access to court floor holding facilities. In the initial construction, however, provisions must be included for future construction of secure holding directly adjacent to the courtroom.
- b. Locate courtrooms for easy access from judicial chambers. Judicial chambers and related support spaces shall be adjacent to the private corridor, providing judges and staff quick courtroom access.
- c. Courtrooms may be assigned to an individual judge. Where courtrooms are not dedicated for use by one bench officer, chambers can be remote from the courtroom.
- d. If chambers are colocated in an area remote from the courtrooms, such as on adjoining floors, a robing room and conference area may be necessary adjacent to the courtroom.

5. Corner Bench or Center Bench Layouts

California courtrooms may use either a corner bench or a center bench configuration. Each offers different design and operational opportunities. Selection of either is a project decision, to be based on the following design and operational criteria:

- Optimum sightlines among the judge, jury, attorneys, and witness
- Ease of accommodating two courtroom clerks
- Ability to move paper documents between clerk and judge
- Sightlines to projected images
- Full accessibility to the bench, other raised platforms, and areas of the courtroom
- Dignity and formality
- Accommodation of courtroom technology and computer equipment
- Space efficiency

5.C COURTROOM ACCESSIBILITY

1. Floor Levels

Because floor levels of courtroom components vary, maintaining sightlines among all components while providing full accessibility shall be a priority.

- The accessible path of travel to the judge’s courtroom workspace (bench), courtroom clerk’s workspace, witness box, and jury box must address the recommended “height above floor” specifications discussed in table 5.1. Separate paths of travel for persons with disabilities shall be avoided.
- The judge’s circulation path must never be in front of the bench.

Table 5.1 Court Component Information

ELEMENT OR WORKSTATION	FURNITURE / CASEWORK WIDTH	DEPTH	HEIGHT ABOVE FLOOR	NUMBER OF OCCUPANTS	AREA SF
Judge	6’–7’	24” MAX	+15”–18”	1	64–80
Courtroom Clerk	10’	24”–27”	+0”–14”	1–2	75–85
CSO	4’	30”	+0”	1	25
Court Reporter	4’	30”	+0”	1	25
Witness Stand	6’		+0”–14”	1 or 2	33–43
Jury Box	N/A	N/A	(1st tier) +0”–7” (2nd tier) 6”–14”	14	144
Counsel Tables	7’–10’	3’–4’	+0”	3 ea.	90–110
Lectern	38”	2’	+0”	0	

Note: Heights of judge, clerk, and witness stand must be in strict relation—judge highest; clerk within 12” of judge; and witness stand at least 6” lower than judge. The number of litigants at the tables can be more if size and configuration permits.

N/A = not applicable.
SF = square feet.

DIVISION ONE: DESIGN CRITERIA

- 1 General Principles
- 2 Courthouse Organization
- 3 Site Design
- 4 Courthouse Security
- 5 COURT SET
 - 5.A Objectives
 - 5.B Courtroom
 - 5.C Courtroom Accessibility
 - 5.D Courtroom Components
 - 5.E Courtroom Support Spaces
- 6 Jury Facilities and Court Administration
- 7 Special Services
- 8 In-Custody Defendant Receiving, Holding, and Transport
- 9 Public Spaces
- 10 Building Support Services

2. Floor Level Changes

Level changes of floors can be achieved in a variety of ways.

- a. Ramps, with handrails as required by code based on the slope of the ramp, are the preferred solution for providing universal access and operationally functional spaces. However, a long ramp may be required in the private corridor, or the private corridor may be constructed at an elevation above that of the primary courtroom floor elevation. A multipurpose courtroom litigation area may accommodate up to 18 people, along with exhibits and a court reporter. Ramps to the courtroom clerk, witness box, and first level of the jury box shall not create a hazard or encroach into the litigation area.
- b. A two-stop lift to the judge's bench, with ramps to the witness area and the clerk at the courtroom floor level, is another approach. However, the Judicial Council does not allow motorized lifts because of operation and serviceability concerns, except in retrofit situations where space is too limited to accommodate ramps. The approach to use motorized lifts should be avoided in new construction.
- c. A three-stop lift to the witness's and judge's level of the bench may be the only choice in retrofit situations where space is extremely limited, but lifts are the least preferred method because their use focuses attention on the person with disabilities, they may require staff assistance to function properly, and they require servicing and testing.
- d. A courtroom millwork finish mockup is required for medium and large projects before casework manufacturing may begin, to ensure that the quality requirements of finish materials are satisfied. The mockup materials shall be reused during the courthouse construction.

5.D COURTROOM COMPONENTS

The following design criteria shall apply to courtroom components.

1. Judge's Bench

The size, location, height, area, and design of the bench reinforce the role of the judge as the administrator of justice and as the principal controller of order in the courtroom. Design the bench to be the focal point of the courtroom without favoring any one party.

- a. Design the bench size and height to be proportionate to the courtroom and to ensure an unobstructed view of and from the entire courtroom. Raise the bench so that the judge's eye level when the judge is seated is higher than that of any standing participant or spectator. The height of the barrier between the judge's bench and the well depends on the actual height of the judge's platform above the well. The attorney's view of the judge's desktop needs to be considered if the judge's platform height is lower as a result of ramping and accessibility issues.
- b. Provide a work surface 72" to 84" wide by a recommended 24" deep with a 3" high privacy screen in front. This area must be of sufficient size to keep paperwork and reference materials within reach and accommodate a computer monitor. The work surface at the judge's bench is not meant for sit-stand configuration but may be adjustable to be higher or lower than the standard work surface height for a comfortable seated position. If the work surface needs to be higher than the in-built 3" privacy screen, a modesty panel may be attached to the table. Provide adequate bookshelves behind or under the bench. Provide an area for conferences between the judge and attorneys at the sidebar. (Sidebars are typically conducted on the side of the litigation area opposite the jury.) Provide built-in or movable undercounter storage drawers and cabinets. Refer to figures 5.2 and 5.3.

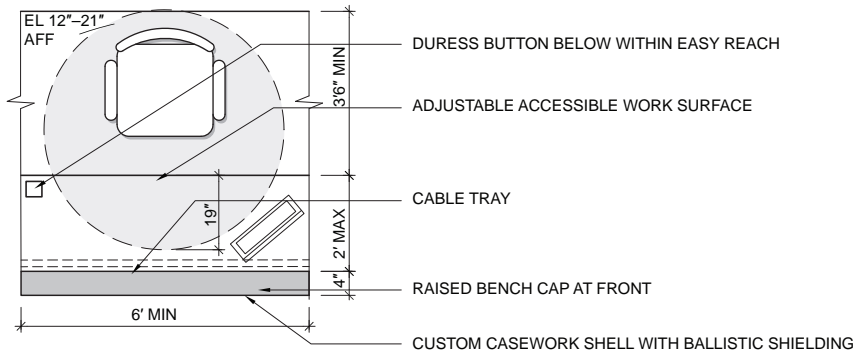

EL = elevation.
AFF = above finished floor.
MIN = minimum.

Figure 5.2 Judge's Bench Plan

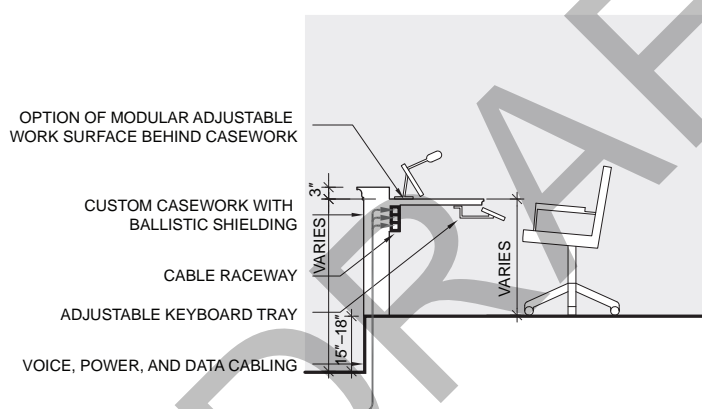

Figure 5.3 Judge's Bench Section

- c. Between the judge's area and the witness box, a fixed barrier of sufficient width and height to prevent a witness from reaching the judge while maintaining sightlines is required. The judge's exit route should be away from the witness.
- d. Provide a minimum of 3'6" between the edge of the judge's desk and the wall behind. This space will accommodate a wheelchair or mobility device and allow the judge sufficient work area. Design the front and sides of the bench to facilitate transfer of documents and verbal communication between the judge, courtroom clerk, and court reporter.
- e. Design the bench with a custom casework wall compatible with the courtroom design. Line the wall with bullet-resistant material that meets the criteria of Underwriters Laboratories' UL 752 Level 3. Provide accessible under-desk cable raceways to accommodate voice, data, video, power, and courtroom technology cabling.

DIVISION ONE: DESIGN CRITERIA

- 1 General Principles
- 2 Courthouse Organization
- 3 Site Design
- 4 Courthouse Security

5 COURT SET

- 5.A Objectives
- 5.B Courtroom
- 5.C Courtroom Accessibility
- 5.D Courtroom Components
- 5.E Courtroom Support Spaces

- 6 Jury Facilities and Court Administration
- 7 Special Services
- 8 In-Custody Defendant Receiving, Holding, and Transport
- 9 Public Spaces
- 10 Building Support Services

The visual and physical relationships between the courtroom elements must be carefully planned to ensure a successful design.

- f. Consider an ergonomic adjustable desk system behind the casework shell in lieu of custom millwork. This component can be made from modular furniture, providing adjustable heights and angles of desktop.
- g. Provide areas for computer equipment, a printer, storage, a telephone, and outlets for data transmission. The bench requires a microphone with a mute button and may include the courtroom audio controls. Provide holes and grommets in the work surface for wire management. Refer to chapter 16, Lighting Criteria, and chapter 18, Audiovisual Systems.

2. Courtroom Clerk's Station

The courtroom clerk is responsible for maintaining a record of case actions and files and for receiving and labeling exhibits. The courtroom clerk must be close to the judge—to transfer exhibit papers and files by hand and to communicate privately—and must be accessible to counsel for marking and introducing documents. The height difference between the clerk's station floor and the judge's bench floor should not exceed 12"; the constant transfer of files creates an ergonomic problem with a greater difference. Consider "pass-throughs" or other millwork solutions to assist in paper passing. See figure 5.4. The clerk's station is located on the same side of the courtroom as the CSO and near a doorway to the private corridor. Access may be provided directly from clerk's station to courtroom well.

- a. The clerk's workstation requires a work surface that is 120" wide by 24" to 27" deep and must accommodate two clerks. An optional 8" to 12" deep shelf in front of the workstation may be added to provide a writing surface and additional screening of documents on the clerk's desk. The clerk's workstation requires substantial area for placement of files, forms, supplies, and other material. Refer to figures 5.5 and 5.6. A telephone equipped with a flashing light rather than a ringer is recommended. An electronic signaling system connecting the CSO's station and the jury deliberation room is required.
- b. Because the clerk's station is the primary work area, design the clerk's station like the judge's bench, compatible with the courtroom design. Provide a custom casework low front wall lined with bullet-resistant material that meets the criteria of UL 752 Level 3, similar to the judge's bench. Behind the paneling, consider using a modular furniture work surface with adjustable height to provide flexibility. Locate a wireless duress alarm button in a discreet location under the work surface. Because this work area is used for all office functions, such as typing and writing, this area must meet all requirements for ergonomic office workspaces.
- c. The clerk's workstation must be cable ready for electronic equipment and requires multiple telephone, data, and electrical outlets and audio controls. Provide concealed, accessible raceways to incorporate voice, data, video, power, and audiovisual cabling.
- d. The clerk's workstation must be designed with space for a printer and possibly a copier. Provide flexibility in terms of locating the printer; some clerks prefer the printer located adjacent to their work surfaces, whereas others prefer it located behind their workstations or immediately adjacent, but not in the courtroom. Provide undercounter file drawers and cabinets for files and forms, and provide file storage behind the workstation. Maximizing the amount of surface area behind the workstation is desirable for stacking case files and other material.

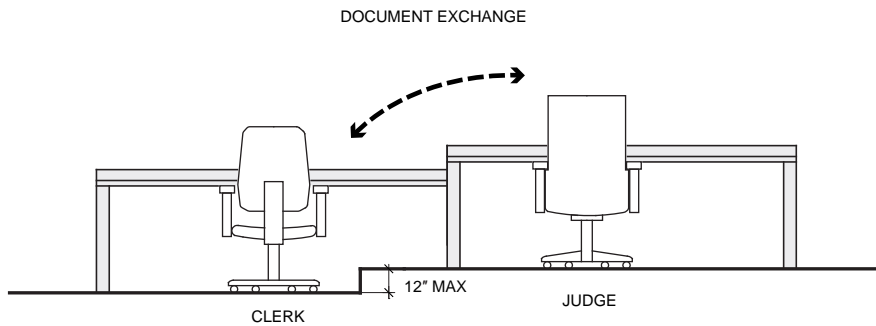

Figure 5.4 Bench and Clerk Elevation

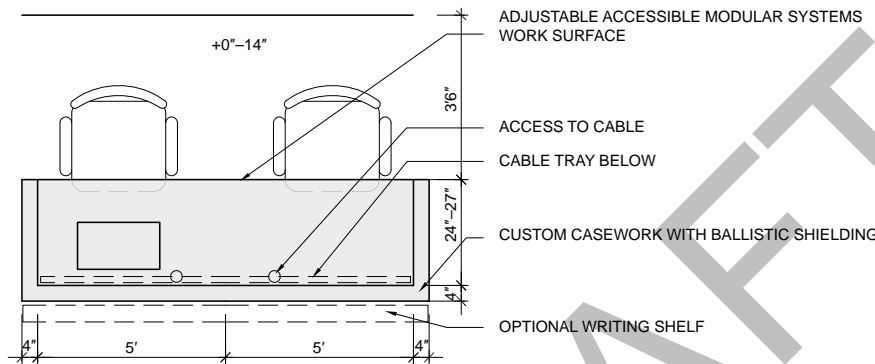

Figure 5.5 Clerk Station Plan

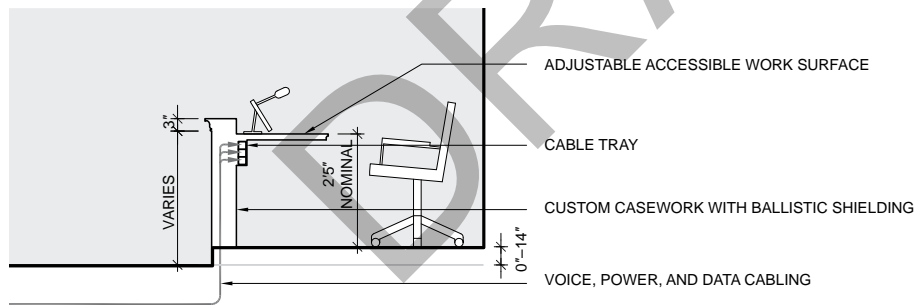

Figure 5.6 Clerk Station Section

3. Witness Box

- a. The witness box shall be located between the judge and the jury and in such a way that the witness's face is clearly visible to the judge, jury, court clerks, court reporter, and counsel tables.
- b. Design the witness box to comfortably seat the witness and interpreter (if required) and to accommodate a wheelchair or mobility device. The witness chair shall be height adjustable and movable, except in certain buildings, where it shall be fixed. Refer to figures 5.7 and 5.8.
- c. Design the witness box to maximize visibility between the jury and the witness.

DIVISION ONE: DESIGN CRITERIA

- 1 General Principles
- 2 Courthouse Organization
- 3 Site Design
- 4 Courthouse Security

5 COURT SET

- 5.A Objectives
- 5.B Courtroom
- 5.C Courtroom Accessibility
- 5.D Courtroom Components
- 5.E Courtroom Support Spaces

- 6 Jury Facilities and Court Administration
- 7 Special Services
- 8 In-Custody Defendant Receiving, Holding, and Transport
- 9 Public Spaces
- 10 Building Support Services

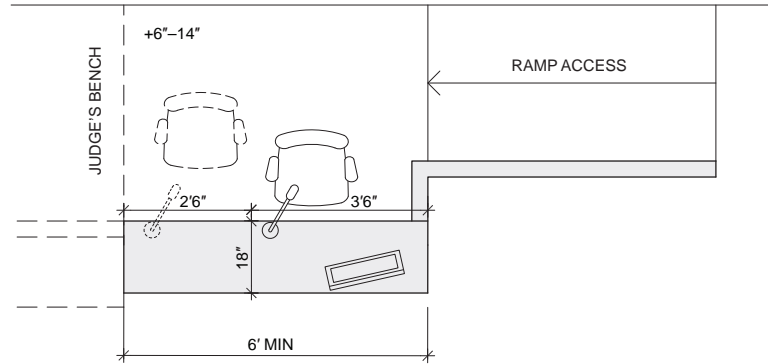

Figure 5.7 Witness Box Plan

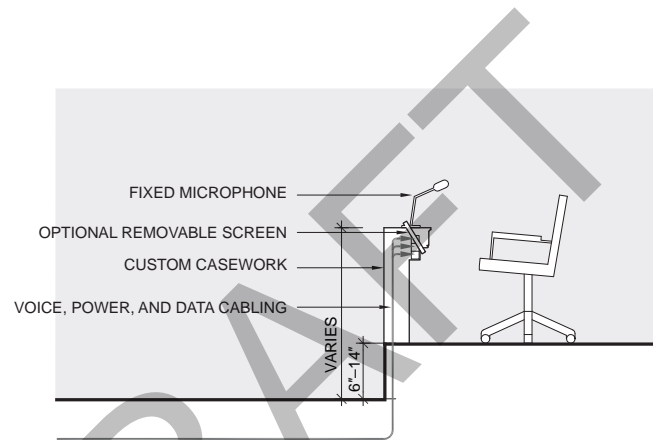

Figure 5.8 Witness Box Section

- d. The witness box must accommodate many people throughout the day. Ramps are the most common and preferred means to provide wheelchair access to this area and a wheelchair turning circle to permit forward entry and exit.
- e. Witness boxes typically have a work surface for reference material, and an expert witness may have a computer for use during testimony. Line the wall behind the paneling of the witness box with bullet-resistant material that meets the criteria of UL 752 Level 3, similar to the judge's bench.

4. Court Reporter's Area

The court reporter provides verbatim recording of all court proceedings.

- a. Locate the court reporter's area so that anything said by participants can be heard by the court reporter, and ensure sightlines to the judge, witness, and attorneys.
- b. Provide a mobile (preferred) or stationary workstation that includes a work surface at least 24" deep, with a lockable drawer for storage and a modesty panel.
- c. Ensure that the workstation is cable ready for in-courtroom headphone audio output and computer-assisted real-time transcription. Provide concealed, accessible raceways to incorporate data, power, and audiovisual cabling.

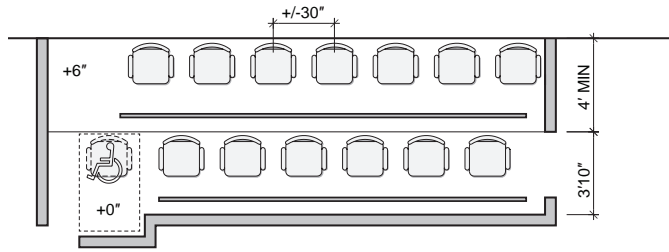

Figure 5.9 Jury Box Plan

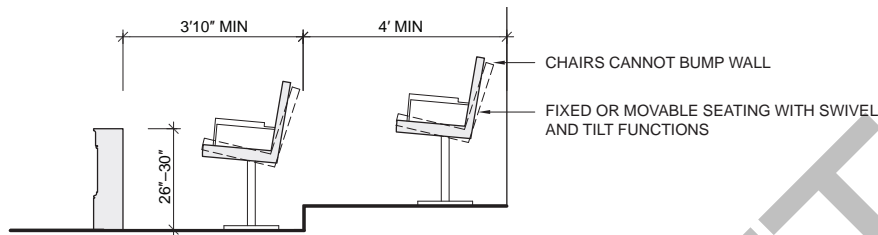

Figure 5.10 Jury Box Section

5. Jury Box

- a. Provide clear sightlines from each juror to the witness, attorneys, judge, courtroom clerk, and evidence displays. The jury box cannot extend past either the witness box or the attorneys' tables. Provide direct access into the jury box from the private corridor to the deliberation room so that the jury does not have to pass in front of the bench or litigant tables. Refer to figures 5.9 and 5.10.
- b. The jury box shall be two-tiered, accommodate people with disabilities, and sized to accommodate 14 people. The dimensions shall be approximately 8' by 18'. The first row of jurors may be at floor level. When locating accessible seating space, provide sightlines equivalent to sightlines for other jury seating, and integrate the accessible position into the overall seating layout so that it is equal in its location and opportunity to the other seats.
- c. Design the jury box to prevent communication between jurors and the spectators and to guard against juror harassment. A space of 6' between jurors and the spectator area railing is recommended. This area may be used to accommodate prospective jury members sitting on movable, stackable chairs while a jury is being impaneled. Where space is insufficient, provide a physical separation such as a transparent panel between the jury and spectator seating.
- d. Provide comfortable, ergonomic jury chairs to accommodate people of all sizes. Chairs may be movable or fixed; however, fixed seating is recommended. The height should be adjustable from 16" to 20". Chairs must swivel and tilt and be spaced so that the arms do not collide and the chairs do not strike the rear wall. Provide sufficient aisle space in front of each row of seats for juror legroom. If required by court, provide writing surfaces that are integral to the jury chairs. Provide a front modesty panel between 26" and 33" in height separating the jury box from the litigation area. Handrails may also be provided. The rear row of seating should be far enough away from the back wall to avoid scuff marks from chair backs or jurors' heads on the back wall. Provide a durable wall material behind the jury box that is resistant to scuff marks from chair backs and head prints from jurors leaning back.

DIVISION ONE: DESIGN CRITERIA

- 1 General Principles
- 2 Courthouse Organization
- 3 Site Design
- 4 Courthouse Security

5 COURT SET

- 5.A Objectives
- 5.B Courtroom
- 5.C Courtroom Accessibility
- 5.D Courtroom Components
- 5.E Courtroom Support Spaces

- 6 Jury Facilities and Court Administration
- 7 Special Services
- 8 In-Custody Defendant Receiving, Holding, and Transport
- 9 Public Spaces
- 10 Building Support Services

- e. High-security courtrooms may incorporate additional elements, such as glass panels, to secure the safety of the jury, spectators, staff, and court personnel and to ensure secure prisoner movement. Verify these requirements during the programming phase. In-custody defendants may not pass in front of the jury box on the way to and from the court floor holding area.

6. Litigation Area

The litigation area, or well, provides space for primary participants in activities of the judicial proceeding. Size varies, depending on courtroom type, and components within the well vary by the type of proceeding.

- a. Counsel tables: Locate counsel tables in the courtroom so that attorneys can be seen and heard by other attorneys, the judge, the witness, the courtroom clerk, the court reporter, and the jury. Provide at least two movable, accessible counsel tables with space for comfortable, ergonomic, movable chairs. The counsel tables shall have a table box for data, video, and power. Separate grommets in the tables shall be provided for the two microphones. Design the floor boxes with flexibility in mind because the counsel tables are movable. Tables shall include a modesty panel to conceal defendant restraint devices. Provide a floor-attached U-bolt for the defense table. The table surface shall be scratch-resistant. Provide an area behind the counsel tables and between the spectator area for a row of chairs along the railing for staff, paralegals, or other involved parties. Refer to figures 5.11 and 5.12. If special counsel is required, particularly in juvenile and domestic cases, provide additional tables or seating at one of the counsel tables.

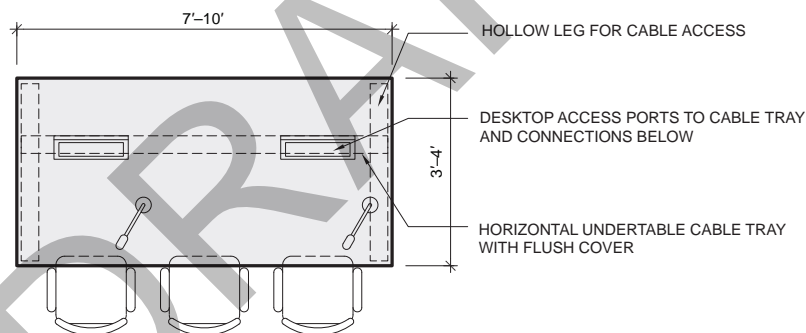

Figure 5.11 Counsel Table

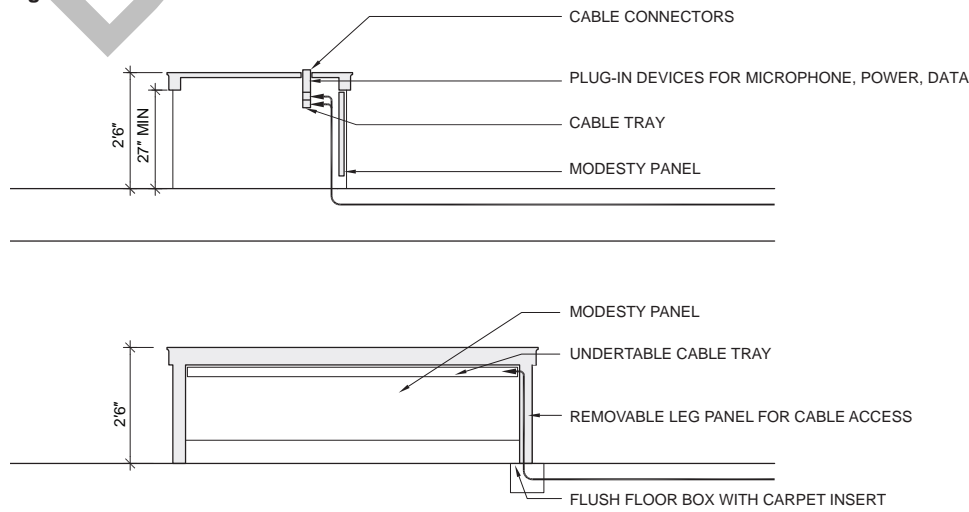

Figure 5.12 Counsel Table Section

- b. Lectern: A movable, height-adjustable, universally accessible lectern may be provided that may be shared between courtrooms and located within reasonable proximity to the counsel tables. The lectern shall be floor supported (not tabletop mounted). Provide a shelf and a gooseneck with a clip for a wireless microphone.
- c. Digital evidence presentation system placed between the two counsel tables: The system can be a cart shared between courtrooms or installed as a fixed shelf. It can contain a document camera and/or a Blu-ray player. Provide a recessed floor box with outlets for data, video, and power.
- d. Egress: Emergency egress from the litigation area may be either out the front of the courtroom to the public corridor or out the rear of the courtroom to the restricted corridor, or some combination of the two. Courts may require controlled access, on private corridor doors, that still allows for emergency exiting. Delayed egress exit devices may be one way of achieving normally locked doors that still allow for emergency egress, provided that all the provisions of California Building Code section 1010 for “delayed egress locks” are satisfied. This solution needs to be approved by the authority having jurisdiction, including the Office of the State Fire Marshal. The California Building Code restricts the use of delayed egress locks in certain occupancy classifications, so courtrooms classified as Group A occupancy require the specific approval from the State Fire Marshal for using delayed egress locks as an alternative means of code compliance.

7. Exhibit Display Area

Provide space for exhibit display and a large ceiling-mounted projection screen or wall-mounted monitor in a location clearly visible to all court participants. (See chapter 18, Audiovisual Systems, for screen size standards.) Provide adequate clearance at the bottom of the screen when fully open to prevent head injuries for those walking by. Plan floor-level transition and steps to avoid a conflict with the projection screen.

8. Court Security Officer (CSO) Station

Locate the CSO’s station within the litigation area to the rear of the well and in front of the spectators’ barrier. The CSO is typically located near the door to the in-custody holding area and requires easy and quick access to the defendant’s table.

- a. Provide the CSO station with a small work surface, modesty panel 36” tall above finish floor, and lockable desk suitable for storage of a service pistol and ammunition. A telephone equipped with a flashing light rather than a ringer is recommended. An electronic signaling system connecting the CSO’s station and the jury deliberation room is required.
- b. Incorporate bullet-resistant material into the paneling of the CSO station, and include a silent duress alarm system in the workstation design.

9. Spectator Area and Litigation Area Separation

The spectator area shall be separated from the litigation area to control movement and reinforce the hierarchy of the participants within the courtroom. This separation element, commonly called the “rail,” may be millwork or predesigned and manufactured and shall have a clear opening at least 44” wide.

**DIVISION ONE:
DESIGN CRITERIA**

- 1 General Principles
- 2 Courthouse Organization
- 3 Site Design
- 4 Courthouse Security

5 COURT SET

- 5.A Objectives
- 5.B Courtroom
- 5.C Courtroom Accessibility
- 5.D Courtroom Components
- 5.E Courtroom Support Spaces

- 6 Jury Facilities and Court Administration
- 7 Special Services
- 8 In-Custody Defendant Receiving, Holding, and Transport
- 9 Public Spaces
- 10 Building Support Services

10. Spectator Area

A multipurpose courtroom has seating in the spectator area for the majority of the jury panel. The number of seats shall be planned to accommodate voir dire panels for jury selection through a combination of seats behind the rail, movable chairs inside the litigation area, and the jury box seating. See figures 5.20 and 5.21, at the end of this chapter.

- a. Provide bench seating in lieu of individual theater-style seats because more people of various sizes can be accommodated and because bench seating is low maintenance. Contour and proportion benches to provide comfortable seating; provide hardwood veneer and solid wood construction. Anchor benches to the floor but make them removable for relocation. Individual theater-style seating systems are not permitted. See figure 5.13.
- b. Provide wheelchair spaces, companion seating, and semiambulatory seating in ratios required by law. Refer to figure 5.13.
- c. In multipurpose courtrooms, accessible seating can be located in one area. In large courtrooms that are wider than a typical multipurpose courtroom, accessible seating areas shall be provided in several locations to equalize sightline advantages. A wide central aisle allows flexibility for persons with disabilities.
- d. A companion seat must be located adjacent to the wheelchair space. The wheelchair space must align with the companion seat. Refer to figure 5.14.
- e. Provide space in front of and behind the wheelchair space such that the spectator using a wheelchair or mobility device can roll forward or backward to allow other spectators to exit a row. The wheelchair or mobility device cannot permanently block exit from an aisle.
- f. Temporary seating, or a fold-down seat, may be placed in wheelchair spaces when not occupied, but is not a preferred option because of the logistics of how the temporary seats are removed when the space is needed for a wheelchair.

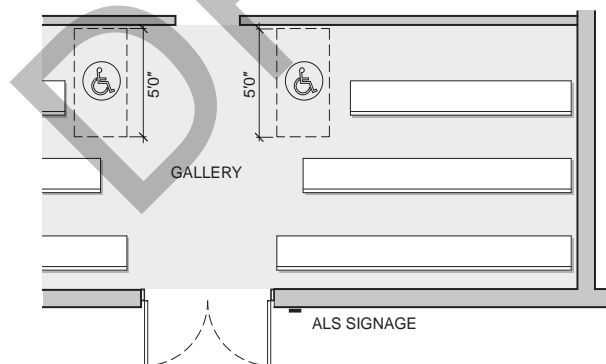

ALS = assistive listening system.

Figure 5.13 Bench-Type Spectator Seating

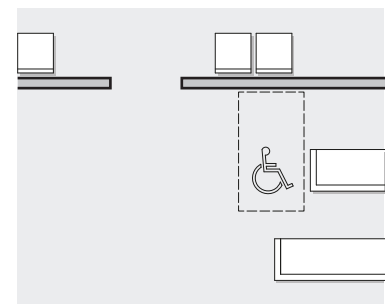

Figure 5.14 Companion Seating Adjacency

11. Sound Lock / Entry Vestibule

Provide a vestibule between the courtroom and the public circulation that will be a transition space and control noise. Place glass panels in the doors from the vestibule into the courtroom (doors from the public corridor into the vestibule are typically solid). The outside

doors from the corridor to the vestibule shall be lockable for security. It is preferable not to have exit devices, latches, or astragals on the doors from the courtroom to the vestibule due to noise considerations. If the attorney-witness conference rooms are needed while the courtroom is dark or locked, the vestibule may be unlocked to provide access. Flexibility in the locking system may be provided on a project-by-project basis.

For high-profile cases, court security staff may provide additional security screening at the courtroom entrance. Consider providing electrical outlets close to the courtroom entries to allow supplemental screening equipment to be plugged in.

12. Exhibit Storage

Provide a secure room or closet for storage of exhibits. For security, install a card reader entry system, camera surveillance, and hard ceiling. This space shall be accessible directly from the courtroom or from the private corridor. Two locking systems for all exhibit storage are recommended to prevent a borrowed access card from allowing access. Wall construction around exhibit storage should be secure and continuous from slab to slab to prevent access from above the ceiling.

13. Evidence Storage

Posttrial evidence storage should be provided in a secure central location adjacent to clerks' secure offices. Refer to the requirements for records storage in chapter 6, Jury Facilities and Court Administration.

5.E COURTROOM SUPPORT SPACES

Jury deliberation rooms and other support spaces off the private corridor may in the future accommodate staff offices or functions different from those in the original program. Therefore, the configurations and fixtures in these spaces must be flexible.

The private corridor and courtroom support spaces may be at a higher floor elevation than the courtroom well to reduce the ramping requirements within the courtroom.

1. Chambers

Chambers are the personal office and conference areas in which the judges conduct legal research and case study, and hold meetings with attorneys or judicial personnel.

- a. Because each judge requires a quiet, distraction-free work environment in which to perform these tasks, separate chambers shall be provided for each judge.
- b. Chambers shall be provided with durable furniture with scratch-resistant work surfaces. Provide holes and grommets in the work surfaces for wire management.
- c. Depending on the number of judges in a facility, one or more additional chambers for use by judges who are not regularly assigned to the court may be provided.
- d. The chambers shall be designed with a private restroom.
- e. Adequate sound control between the chambers and the staff and reception areas shall be provided to reduce sound transmission during sensitive conference sessions.
- f. Natural lighting shall be provided to the chambers. Refer to figure 5.15.
- g. Judicial chambers may be clustered for improved collaboration and to share support functions. If chambers are clustered, space may be conserved and costs reduced by providing a common restroom to be shared among judges and a separate shared restroom for staff. Refer to figure 5.16.

DIVISION ONE: DESIGN CRITERIA

- 1 General Principles
- 2 Courthouse Organization
- 3 Site Design
- 4 Courthouse Security

5 COURT SET

- 5.A Objectives
- 5.B Courtroom
- 5.C Courtroom Accessibility
- 5.D Courtroom Components
- 5.E Courtroom Support Spaces

- 6 Jury Facilities and Court Administration
- 7 Special Services
- 8 In-Custody Defendant Receiving, Holding, and Transport
- 9 Public Spaces
- 10 Building Support Services

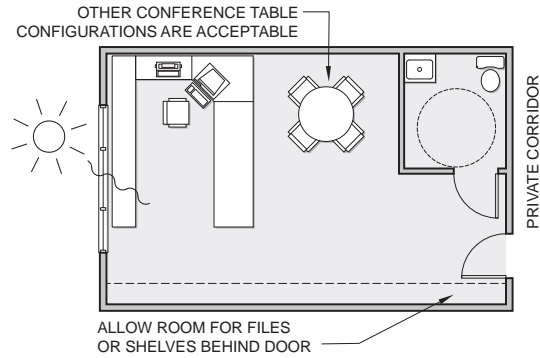

Figure 5.15 Judge's Chamber Plan

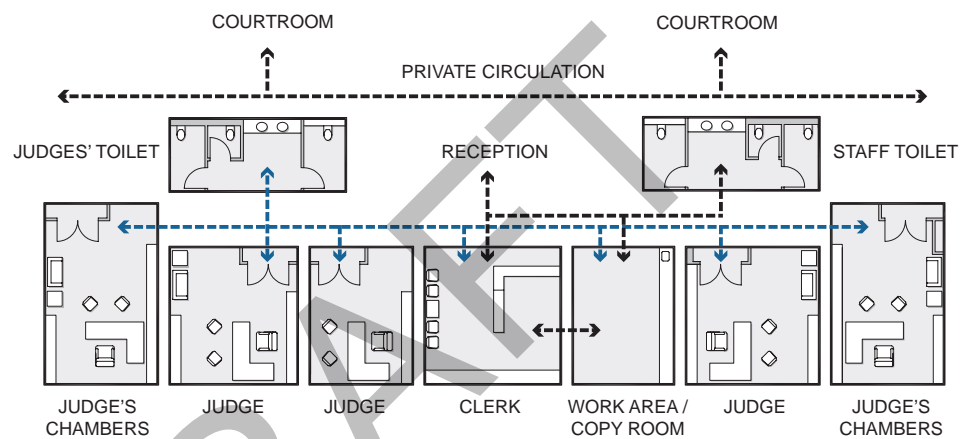

Figure 5.16 Clustered Chamber Layout

2. Support Staff Workstations, Reception, and Waiting Areas

The judicial office may be adjacent to and entered through an anteroom that contains space for floating courtroom clerks and support staff who perform clerical functions, receive and screen visitors, and maintain legal files for one or more judges. In some cases, this area may function as an unstaffed waiting area. The size of this area depends on related functional requirements.

3. Copy, Workroom, and Supply Area

Provide a copy, workroom, and supply area containing photocopy and fax machines to be accessible to judicial support staff, research attorneys, attorneys, and CSOs. A ratio of one copy workroom for every four to eight judges is required.

4. Court Reporter's Work Area

Court reporters transcribe court proceedings and review transcripts. Provide a separate court reporter's work area, grouping multiple court reporter workstations in a larger area. Locate the work area on the private corridor on the same floor as the courtrooms, on nearby courtroom floors, or on a court administration floor. Provide an area for locked transcript storage and general office supplies inside or adjacent to the court reporter's work area. Provide a shared counter space to assemble transcripts; provide cubicles with higher divider walls for regular work.

5. Conference Room

A conference room may be provided for judges as defined in the project program. This area may include bookshelves for reference materials. In small courts, this area may be combined with the jury deliberation function, provided that legal books are not accessible to jurors. A designated law library is not permitted.

6. Research Attorney Offices and Workstations

Space may be provided for research attorneys, who review case files and perform legal research for one or more judges.

7. Jury Deliberation Room

Provide jurors a private deliberation room that is free from distractions and outside interference, accessible from the private corridor. Refer to figures 5.17–5.19.

- a. Provide not more than one juror deliberation room for every two courtrooms, and consider one deliberation room for every three courtrooms. The ratio may be verified by a study, during programming, of the recent data on the number of jury deliberations at a particular court; however, more than one jury deliberation room per two courtrooms must be approved by the Judicial Council. For efficiency and flexibility, some jury rooms can be initially assigned for other courtroom support functions in the program but must be convertible to jury rooms without remodeling.
- b. Design the jury deliberation room to accommodate a table allowing all jurors, including persons with disabilities, to participate equally without hierarchy. Round or square tables are preferred to long rectangular tables.
- c. The jury deliberation room shall comfortably accommodate 12 jurors and allow use of charts, mounted exhibits, and video monitors for evidence.
- d. Provide one accessible toilet room positioned so that the door opens from a vestibule. Orient the toilet room door for sound attenuation and to provide reasonable privacy to the toilet room.
- e. Provide a counter with lower cabinet and space for a water bottle filling station.
- f. Provide space for coat storage, which can be either a coat rack or a built-in closet space.
- g. The room shall have natural light; ensure that windows do not allow jurors to communicate with people outside the court facility.
- h. Jury deliberation rooms shall be designed in a flexible manner so that they can easily be converted into a chambers to accommodate assigned judges.

8. Attorney-Client Conference Rooms

Provide conference rooms for attorneys and clients and for use by witnesses.

- a. Provide two attorney conference rooms for every courtroom. In larger court facilities, the ratio of conference rooms may be reduced. One room may be eliminated to add spectator seating.
- b. Conference rooms may be accessible from the public corridor, if consistent with the court's security and operational procedures, or may be reached through the courtroom entry vestibule, if access can be provided but controlled when the courtroom is not occupied.

DIVISION ONE: DESIGN CRITERIA

- 1 General Principles
- 2 Courthouse Organization
- 3 Site Design
- 4 Courthouse Security

5 COURT SET

- 5.A Objectives
- 5.B Courtroom
- 5.C Courtroom Accessibility
- 5.D Courtroom Components
- 5.E Courtroom Support Spaces

- 6 Jury Facilities and Court Administration
- 7 Special Services
- 8 In-Custody Defendant Receiving, Holding, and Transport
- 9 Public Spaces
- 10 Building Support Services

- c. In addition, provide a secure attorney-client interview room adjacent to courtroom holding. The court security officers should have the ability to control from the courtroom both sides of the secure interview room. Refer to tool 5, In-Custody Interview Room Guidelines.

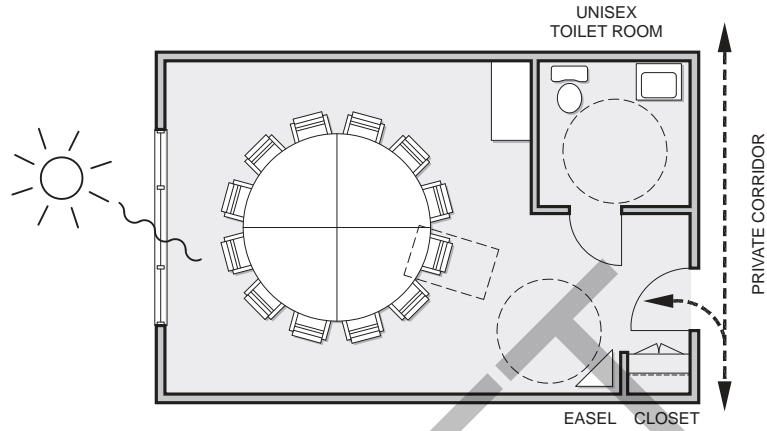

Figure 5.17 Jury Deliberation Room 400 SF

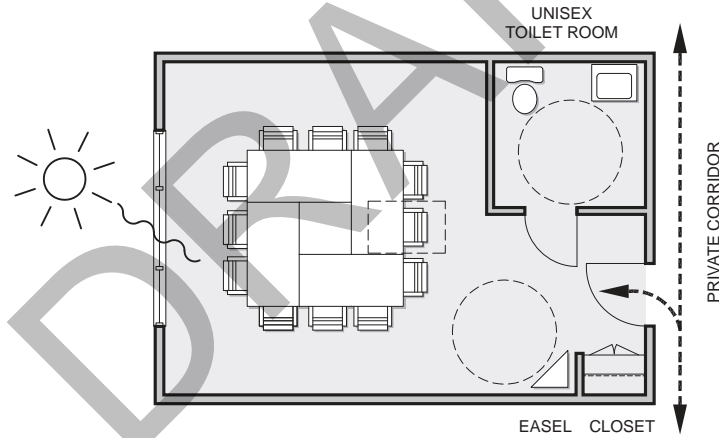

Figure 5.18 Jury Deliberation Room 345 SF

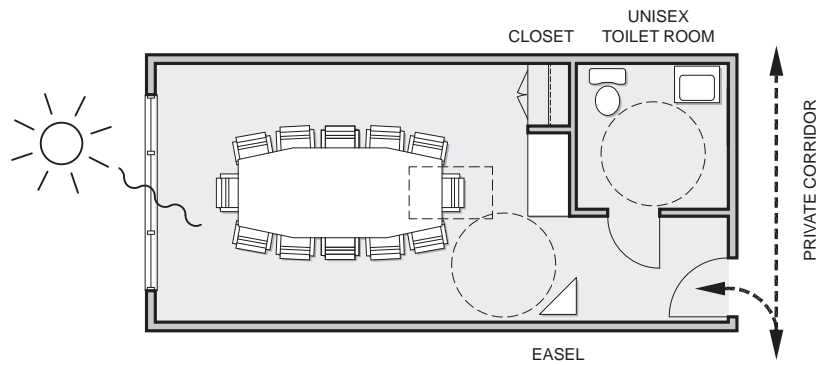

Figure 5.19 Jury Deliberation Room 300 SF

DRAFT

Page intentionally left blank

**DIVISION ONE:
DESIGN CRITERIA**

- 1 General Principles
- 2 Courthouse Organization
- 3 Site Design
- 4 Courthouse Security

5 COURT SET

- 5.A Objectives
- 5.B Courtroom
- 5.C Courtroom Accessibility
- 5.D Courtroom Components
- 5.E Courtroom Support Spaces

- 6 Jury Facilities and Court Administration
- 7 Special Services
- 8 In-Custody Defendant Receiving, Holding, and Transport
- 9 Public Spaces
- 10 Building Support Services

Figure 5.20 Variations

- Ramping requirements may be reduced for judge’s bench and clerk’s station if private corridor is at a higher floor elevation than the courtroom floor.
- Refer to spectator seating layout shown in figures 5.22 and 5.23 for seating layout in large courtrooms.

Figure 5.21 Variations

- Ramping requirements will increase for judge’s bench and clerk’s station if private corridor is at the same floor elevation as the courtroom floor.
- Refer to spectator seating layout shown in figures 5.22 and 5.23 for seating layout in large courtrooms.

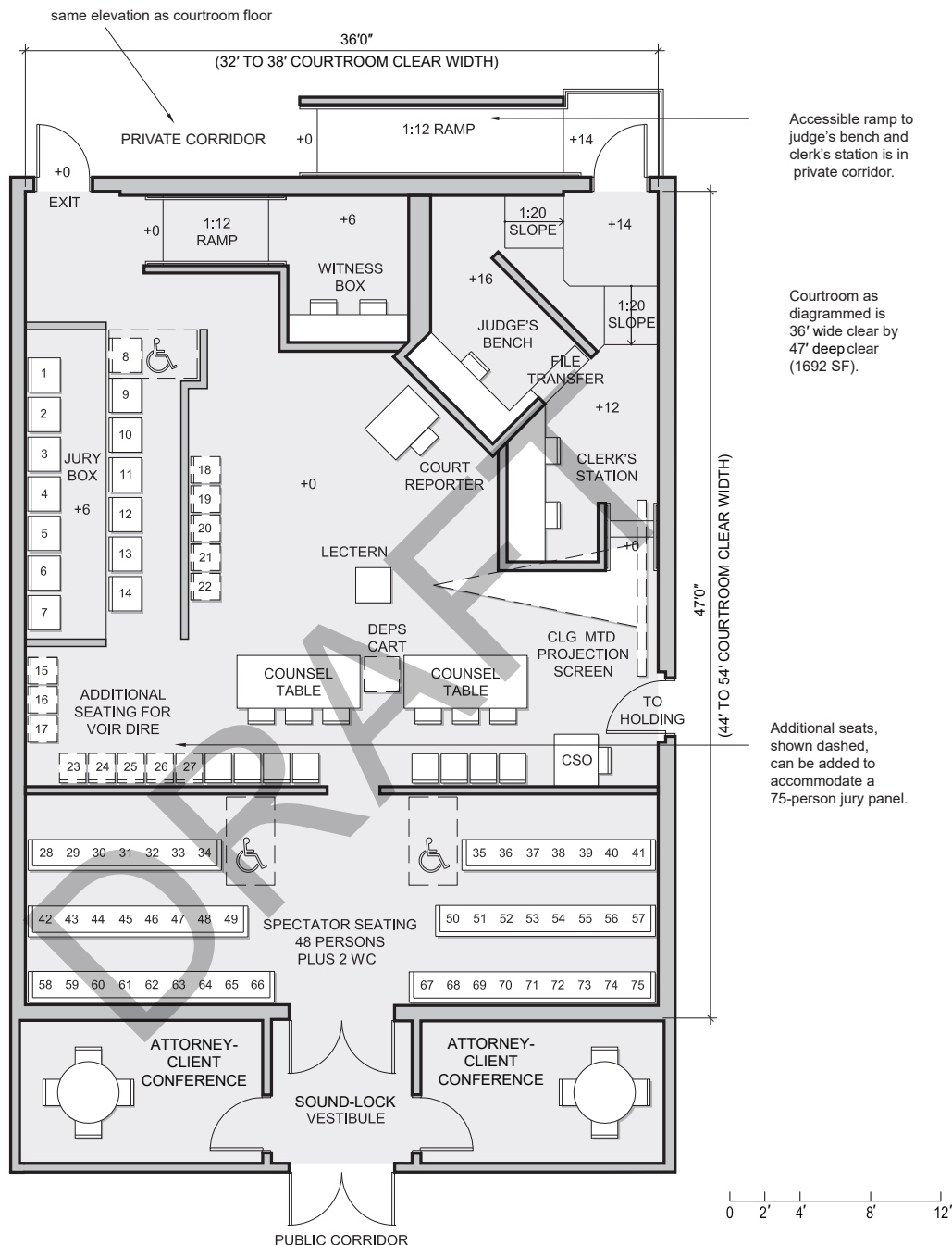

Accessible ramp to judge’s bench and clerk’s station is in private corridor.

Courtroom as diagrammed is 36’ wide clear by 47’ deep clear (1692 SF).

Additional seats, shown dashed, can be added to accommodate a 75-person jury panel.

DEPS = digital evidence presentation system.
 CLG MTD = ceiling mounted.
 WC = wheelchairs.
 ATTY CONF = attorney conference room.

Note: For illustration of courtroom components only. Refer to tool 2, Catalog of Courtroom Layouts for California Trial Courts, for courtroom template plans.

Figure 5.20 Multipurpose Courtroom (Corner Bench, Seating for Jury Panel)

**DIVISION ONE:
DESIGN CRITERIA**

- 1 General Principles
- 2 Courthouse Organization
- 3 Site Design
- 4 Courthouse Security

- 5 COURT SET**
 - 5.A Objectives
 - 5.B Courtroom
 - 5.C Courtroom Accessibility
 - 5.D Courtroom Components
 - 5.E Courtroom Support Spaces

- 6 Jury Facilities and Court Administration
- 7 Special Services
- 8 In-Custody Defendant Receiving, Holding, and Transport
- 9 Public Spaces
- 10 Building Support Services

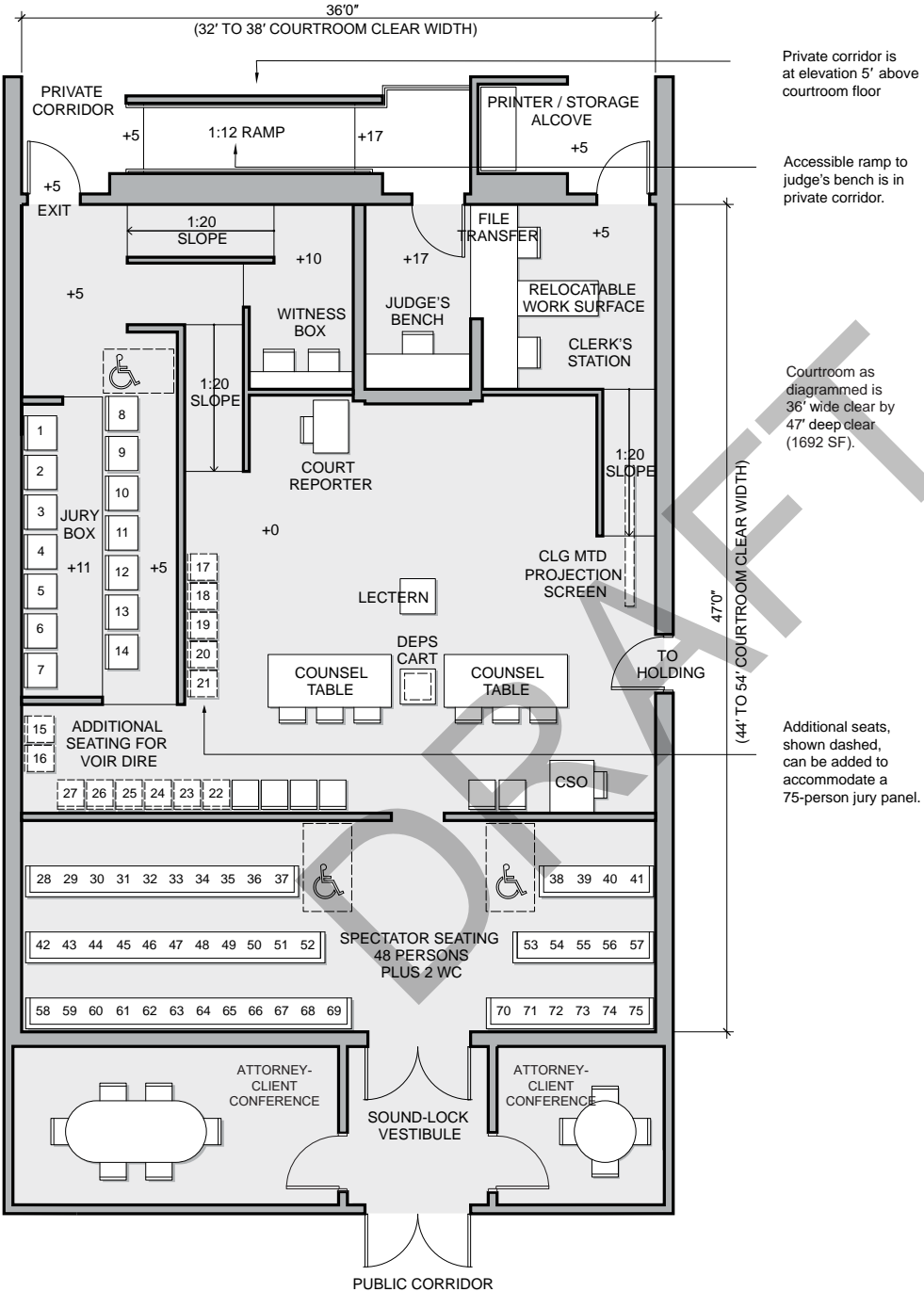

Note: For illustration of courtroom components only. Refer to tool 2, Catalog of Courtroom Layouts for California Trial Courts, courtroom template plans.

Figure 5.21 Multipurpose Courtroom (Central Bench—Asymmetrical)

Figure 5.22 Variations

- Ramping requirements will increase for judge's bench and clerk's station if private corridor is at the same floor elevation as the courtroom floor.
- In-custody dock may alternatively be located outside of courtroom perimeter in holding area.

Figure 5.23 Variations

- Ramping requirements will increase for judge's bench and clerk's station if private corridor is at the same floor elevation as the courtroom floor.
- In-custody dock may alternatively be located outside of courtroom perimeter in holding area.

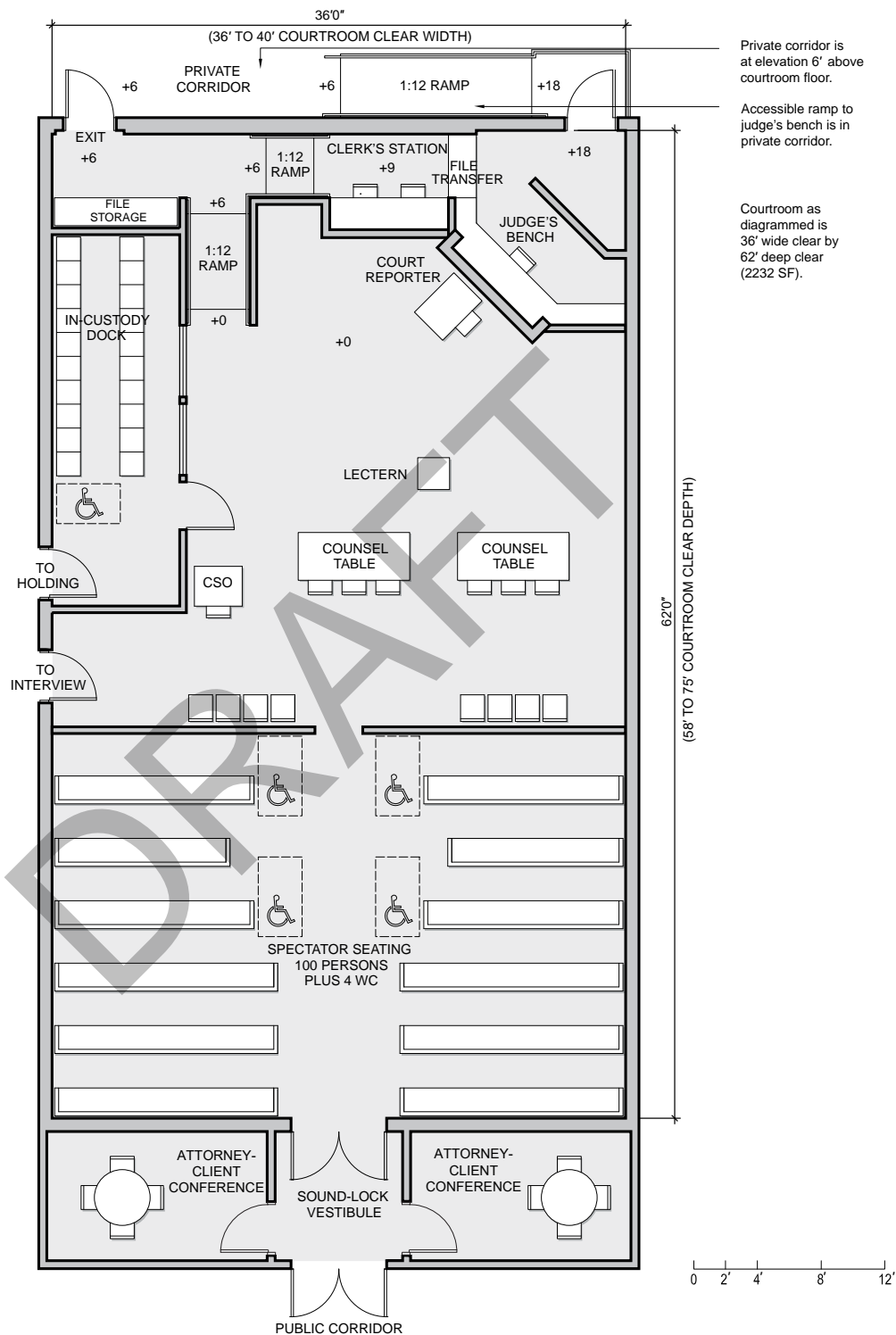

Note: For illustration of courtroom components only.

Figure 5.22 Arraignment Courtroom (Corner Bench)

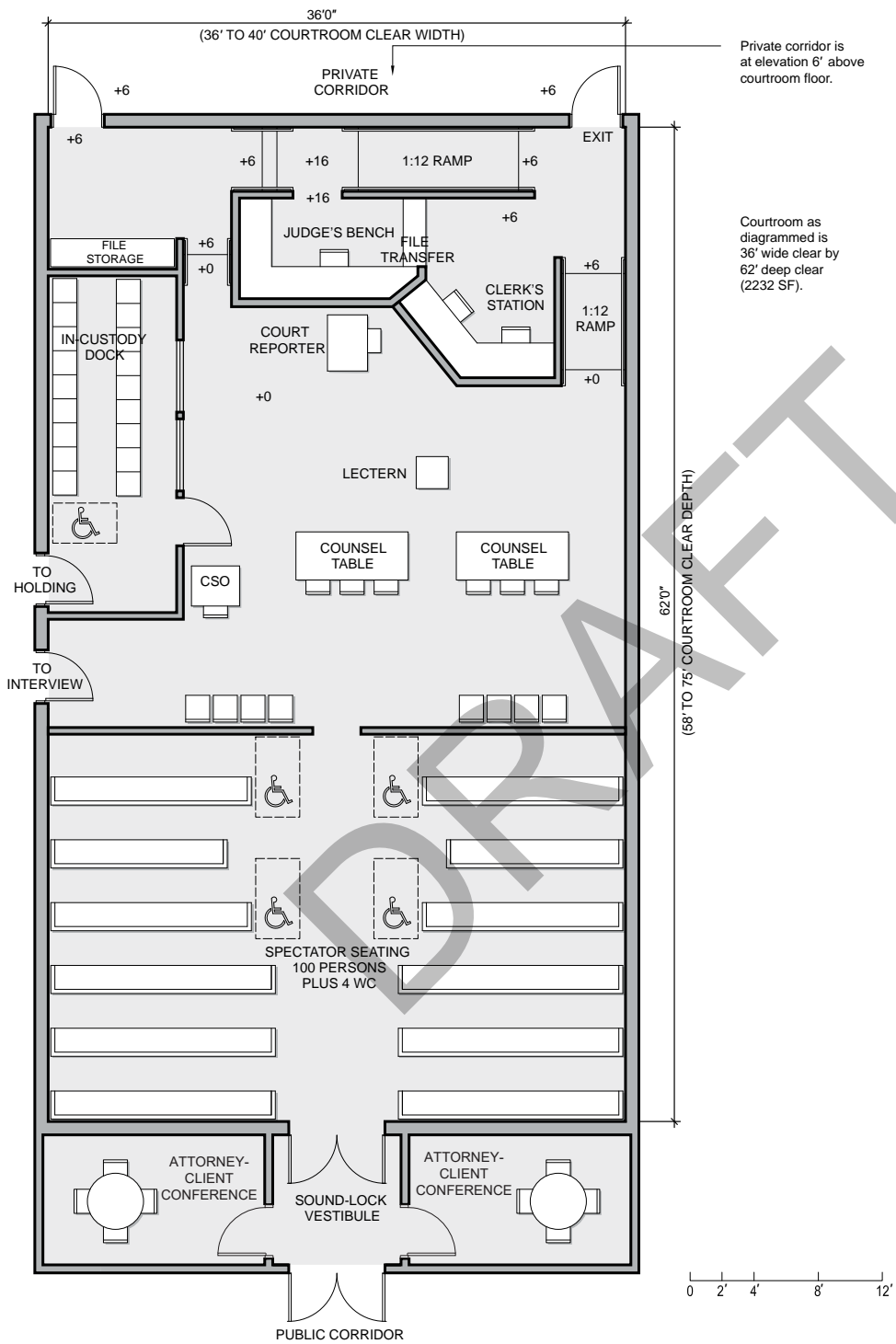

Note: For illustration of courtroom components only.

Figure 5.23 Arraignment Courtroom (Central Bench)

DIVISION ONE: DESIGN CRITERIA

- 1 General Principles
- 2 Courthouse Organization
- 3 Site Design
- 4 Courthouse Security

5 COURT SET

- 5.A Objectives
- 5.B Courtroom
- 5.C Courtroom Accessibility
- 5.D Courtroom Components
- 5.E Courtroom Support Spaces

- 6 Jury Facilities and Court Administration
- 7 Special Services
- 8 In-Custody Defendant Receiving, Holding, and Transport
- 9 Public Spaces
- 10 Building Support Services

DRAFT

DIVISION ONE: DESIGN CRITERIA

6

JURY FACILITIES AND COURT ADMINISTRATION

SECTION	TOPIC	PAGE
6.A	Jury Facilities Objectives	6.2
6.B	Jury Assembly Spaces	6.2
6.C	Objectives of the Clerk's Office	6.5
6.D	Clerk's Office Spaces	6.5
6.E	Court Executive Officer's Area	6.9

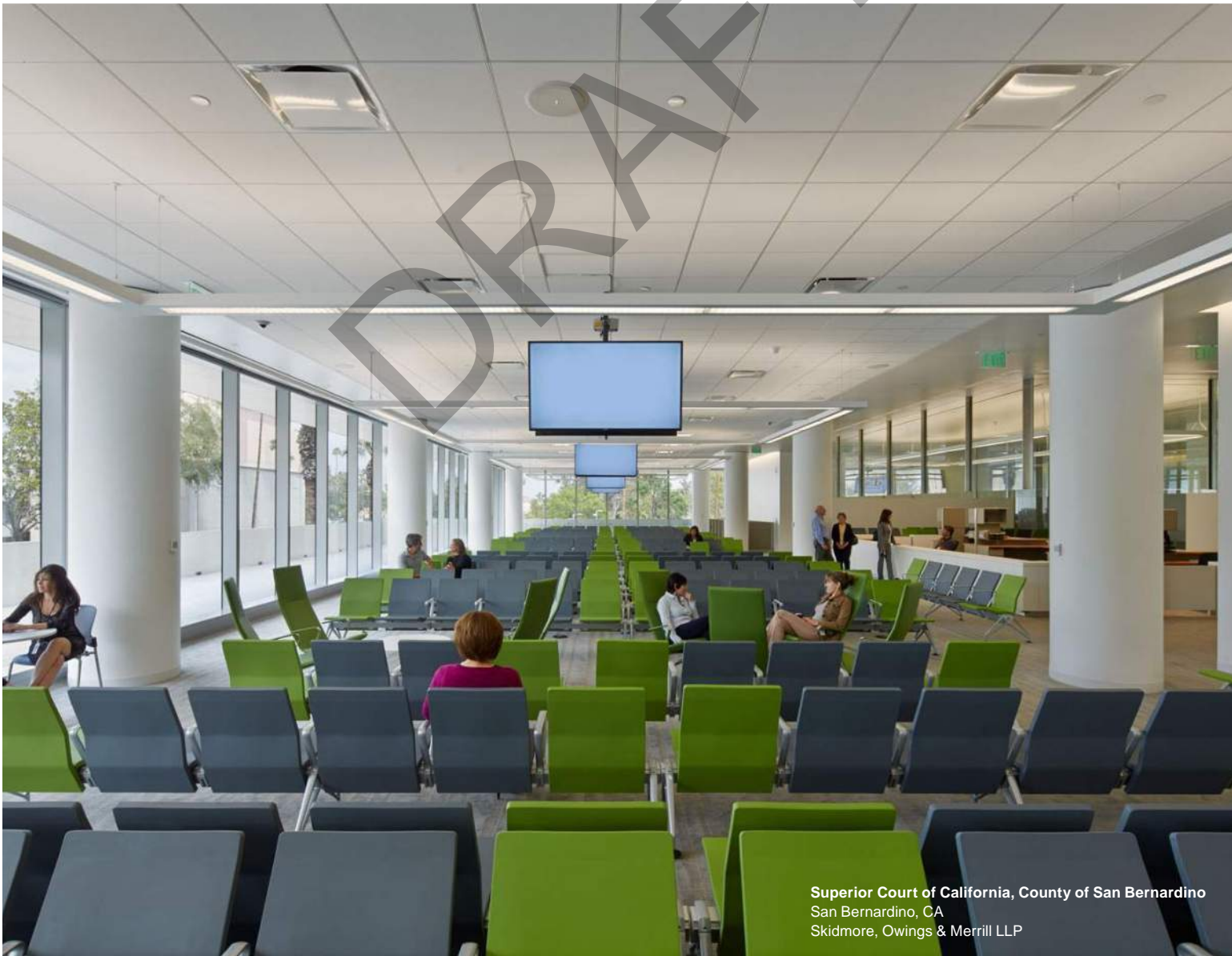

Superior Court of California, County of San Bernardino
San Bernardino, CA
Skidmore, Owings & Merrill LLP

Jury Assembly Spaces

- Entry Queuing Area
- Reception, Check-In, and Registration
- Jury Assembly Room and Information Presentation Area
- Forms Counter
- Coffee and Snack Area
- Jury Staff Area
- Mail Center
- Call Center

6.A JURY FACILITIES OBJECTIVES

Jury duty is a public service obligation. For many citizens, jury duty is their only contact with the judicial system. The jury assembly area presents potential jurors with a physical symbol of the importance of their duty and orients them to the process of the courts.

- a. Plan and design the jury assembly rooms to be comfortable, efficient, and safe.
- b. Locate, size, and configure the spaces appropriately to facilitate use by potential jurors.
- c. Ensure that all jury assembly areas can be monitored by jury staff.
- d. Because technology and new operational models will continue to affect jury call and associated space needs, jury assembly spaces should be designed to consider future changes, such as online jury summons processes, that will reduce or eliminate the need for such large spaces. Jury assembly rooms should be designed to allow for easy conversion to other uses.

6.B JURY ASSEMBLY SPACES**1. General Requirements**

The jury assembly area is a high-volume public access function and should be located on the building's entry floor or lower floor.

- a. All prospective and selected jurors must enter through a screening station. The entrance to the jury area must be easy to locate upon entering the courthouse and easily accessible from public corridors.
- b. Jury staff must be able to control the entry into the jury assembly area.
- c. Ensure that traffic to the jury assembly room does not interfere with public circulation in the lobby, stairs, or elevators. Plan movement of jurors to minimize juror contact with attorneys and litigants and to preclude intimidation by and contact with the public.
- d. Protect the assembly area from exterior viewing.

2. Components

The jury assembly area consists of several unique components, described below.

2.1. Entry Queuing Area

- a. Prominently placed signage shall provide clear directions to the jury assembly area. Jurors arrive simultaneously, so queuing areas will be required for prospective jurors waiting to sign in.
- b. The queuing area can be colocated within a lobby, waiting area, or building circulation. The queuing area should be within the jury assembly room to prevent contact with defendants, family members of defendants, and witnesses.

2.2 Reception, Check-In, and Registration

- a. The reception, check-in, and registration area shall be immediately visible at the entry of the jury area. The size of this area will depend on the number of courtrooms and the peak volume of anticipated jurors expected at sign-in times. Self-check-in kiosks may be considered in this location.
- b. Provide standard clerical support workstations (refer to table 2.2).
- c. Provide counter space at the registration counter for jurors.
- d. Provide at least six trauma kits in an easily accessible and recognizable

container located next to an automated external defibrillator (AED) as required by Health and Safety Code section 19300.

2.3. Jury Assembly Room and Information Presentation Area

- a. Sufficient seating shall be provided for all prospective jurors. Provide movable grouped seating and lounge seating with power supply. The minimum number of seats will vary by the size and location of the facility. Provide wheelchair spaces, companion seating, and semiambulatory seating in ratios required by law.
- b. Provide areas for reading, studying, working, and watching television, designed as acoustically separated rooms or alcoves adjacent to the jury assembly area. Work areas shall include study carrels, Wi-Fi, and power connections for personal electronic devices. See figure 6.1.



Figure 6.1 Seating and Work Areas in Jury Assembly Room, Superior Court of Tulare County, Porterville

- c. Jury assembly rooms may serve as multipurpose community rooms during business hours or off-hours. Therefore, the design of the jury assembly area should permit partitioning the assembly area from the rest of the courthouse functions during off-hours. The Judicial Council Facilities Services office shall be consulted for off-hours requests.
- d. Jury assembly rooms in courthouses without dedicated training rooms shall be designed and constructed to the same standards as training rooms to enable them to be used for training and other collaborative activities with full multimedia capabilities. This design includes the use of nonfixed, easily removable seating to allow for flexible room setups. In addition, these rooms should be designed to allow use for training sessions without disturbing jury services staff.
- e. Restroom facilities should be located within or close to the jury assembly room.
- f. Provide a movable lectern for juror orientation and infrastructure for wireless or cell phone access.
- g. At the information presentation area, provide for use of audiovisual equipment, computer data lines, and telecommunications systems to accommodate

DIVISION ONE: DESIGN CRITERIA

- 1 General Principles
- 2 Courthouse Organization
- 3 Site Design
- 4 Courthouse Security
- 5 Court Set

6 JURY FACILITIES AND COURT ADMINISTRATION

- 6.A Jury Facilities Objectives
- 6.B Jury Assembly Spaces
- 6.C Objectives of the Clerk's Office
- 6.D Clerk's Office Spaces
- 6.E Court Executive Officer's Area
- 7 Special Services
- 8 In-Custody Defendant Receiving, Holding, and Transport
- 9 Public Spaces
- 10 Building Support Services

programs such as video orientation, automated jury management systems, and juror call-in programs. Provide glare control for video orientations. See chapter 17, Network and Communication Systems, and chapter 18, Audiovisual Systems, for technical requirements.

Outdoor areas may be provided if they are within the building's secure perimeter and jurors are prevented from public viewing and contact.

2.4 Forms Counter

Provide counters for filling out forms. A reasonable proportion of the counter space shall be designed for accessibility by people in wheelchairs.

2.5 Coffee and Snack Area

- a. Provide space for a minimum of three or four vending machines, a table, chairs, and a space for water and coffee. Room size shall be proportionate to the number of people served; in larger facilities, the area may be increased commensurately.
- b. Space for a vendor may be provided in some facilities. This area is usually provided in a separate alcove to contain food-related mess and minimize noise impact on the assembly and work areas. Depending on other food service in the building, this vending area may need to be accessible to nonjurors.

2.6 Jury Staff Area

In cases where jury staff screen jurors, an adjoining space may be necessary for the jury coordinator or for staff consultation. In larger courthouses, space for additional support staff not located in the jury reception area may be required.

- a. The size of the support space area will be proportionate to the size of the court facility.
- b. The jury office will be readily accessible to the reception counter.

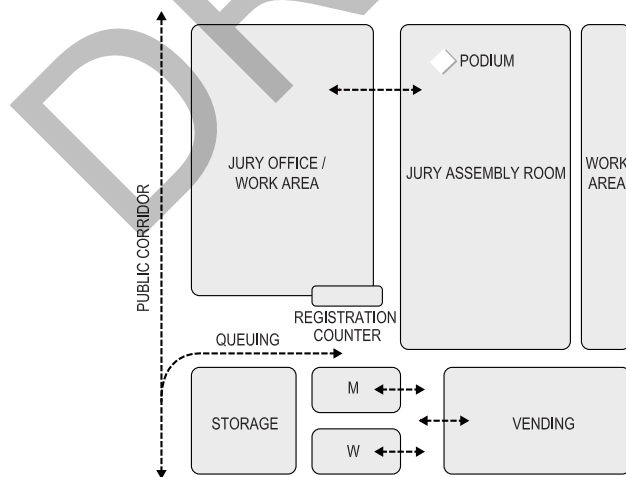

Figure 6.2 Jury Assembly Suite Adjacency Diagram

- c. Provide sufficient space for storage of jury records and files. See figure 6.2.

2.7 Mail Center

If required, provide a work area where staff can prepare juror summonses, scan

summons return information, and print checks. Most courts outsource summons preparation, printing, and mailing or centralize this function with other mail activities.

2.8 Call Center

Provide a work area where staff can answer telephone queries. Larger facilities often use call centers or interactive voice response.

6.C OBJECTIVES OF THE CLERK'S OFFICE

The trial court's administrative organization combines the traditional public and case management functions of the clerk with the financial and administrative services of a modern business. Clerk responsibilities include case filing and tracking, records administration, calendar management, fines and fees collection, and sharing public information. Business services may include human resources, budget management, and information services activities; statistical reporting; and purchasing.

The number of court staff varies by jurisdiction. Variables influencing court staffing include the number of judicial officers, number and type of case filings, number of court locations, and extent to which business services are provided internally or are contracted with other entities.

- a. Colocate functions of the clerk's office (CO) and provide convenient public access to areas with high public contact. These areas should be located on lower floors near the main entry and public elevators in a multistory building. Provide staff areas with easy access to the private circulation system. Connect the CO to private and public corridors, allowing controlled access to judicial officers, courtroom personnel, attorneys, and the general public.
- b. Ensure that the appearance of the CO is consistent with the rest of the courthouse. The public side of the counter area must have durable finishes. The counters, workstations, and public viewing stations shall make use of modular furniture where appropriate to maximize complete ergonomic and expansion flexibility. The clerk's office shall be an open-office environment with modular furniture appropriate for a public agency.
- c. Consider making rooms more flexible by providing telephone, data, and power outlets in areas that may be converted to workstations, offices, or conference areas. Electronic case management will affect future record storage areas that may be required, and these areas must be designed with flexibility in mind for conversion to other program needs.
- d. Provide security to ensure the safety of the public, staff, records, and exhibits. Integrate security duress alarm notification systems into the courthouse security system. Consider security elements in the public service lobby. Incorporate glass and closed-circuit television cameras at the public counter area. At transaction windows that are not accessed through the public entry weapons-screening station, provide bullet-resistant glass barrier systems and counter casework. Provide the evidence storage room and vault with locks and intrusion alarms, located in an area that allows constant supervision. CO staff access shall be restricted by use of key cards or other devices.

6.D CLERK'S OFFICE SPACES

The clerk's office area consists of the following spaces. See figure 6.3 for a typical layout.

1. Public Counter and Counter Workstation

- a. Design public service counters to encourage access to the judicial system while providing security for office personnel. Counters allow sufficient work area to transact case filing activities, and they separate private staff office areas from public areas.

DIVISION ONE: DESIGN CRITERIA

- 1 General Principles
- 2 Courthouse Organization
- 3 Site Design
- 4 Courthouse Security
- 5 Court Set

6 JURY FACILITIES AND COURT ADMINISTRATION

- 6.A Jury Facilities Objectives
- 6.B Jury Assembly Spaces
- 6.C Objectives of the Clerk's Office
- 6.D Clerk's Office Spaces
- 6.E Court Executive Officer's Area
- 7 Special Services
- 8 In-Custody Defendant Receiving, Holding, and Transport
- 9 Public Spaces
- 10 Building Support Services

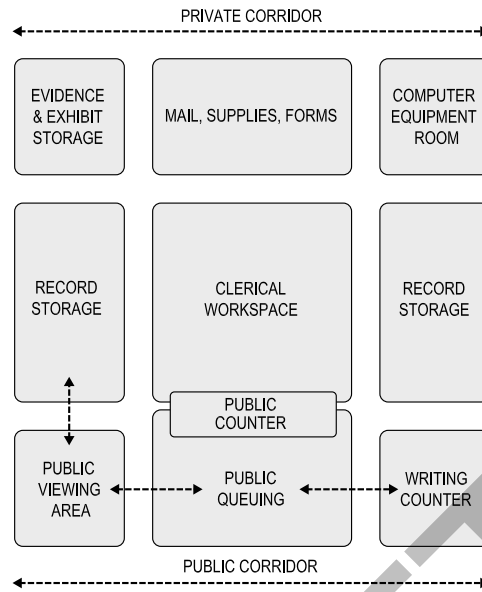

Figure 6.3 Clerk's Adjacency Diagram

Design spaces to ensure efficient and secure acceptance, exchange, review, and reproduction of high volumes of public documents. Size the pass-through window to prevent physical intrusion.

- b. Locate one or more universally accessible counters closest to the entrance. Such counters must have the ability to accommodate wheelchair users on each side. Two counter workstation design options are available:
 - Option 1: Staff workstations shall be designed at an elevation above the public floor that allows for seated, eye-level interaction with customers standing at the counter. Refer to figure 6.4. An accessible writing surface is required on the public side, with 12"–18" depth. A raised solid barrier between openings should screen the view of computer and desktop items. The divider height is limited by reach distance. If a raised platform is provided, consider the ability of clerks to obtain records easily.
 - Option 2: Staff and public sides shall be accessible at a seated level. Refer to figure 6.5. Provide a single-height writing surface that meets accessible height and depth requirements. This height will accommodate people standing and people in wheelchairs. Sightlines and sound levels when speaking must be considered in this model. For longer transactions, movable seating may be provided for the public; the public may stand for short transactions.
- c. Staff assignments to counter workstations may be to permanent, rotating, or walk-up counters. A *permanent* counter means that counter station is the dedicated and only workspace for the assigned staff and needs to have all the support necessary for a clerk staff workstation. *Rotating* and *walk-up* counters require that counter staff have dedicated workstations elsewhere.
- d. Design each counter position to include the counter, staff workspace on the private side, and a standing area on the public side.
- e. Provide for confidentiality and privacy on the public side, between windows.

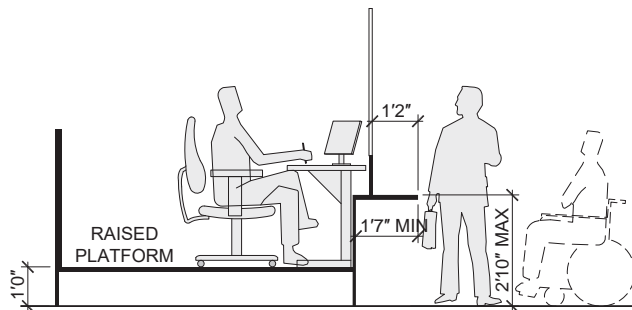
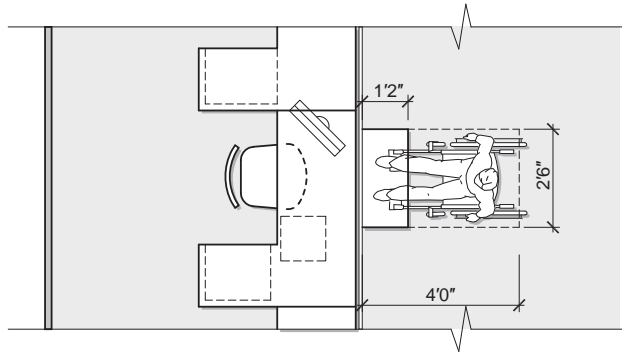

Figure 6.4 Transaction Height Counter

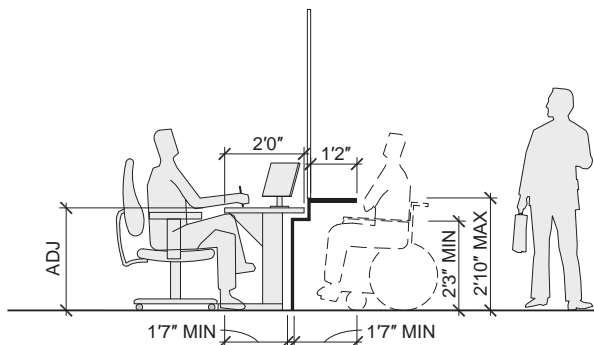
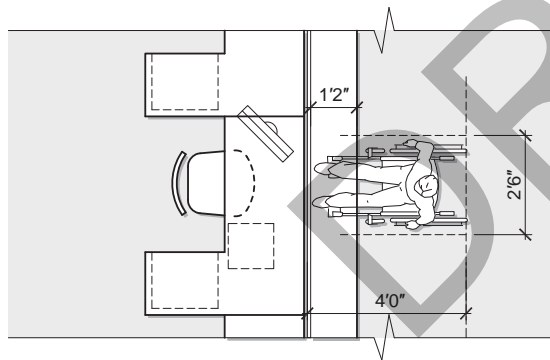

Figure 6.5 Universal Height Counter

**DIVISION ONE:
DESIGN CRITERIA**

- 1 General Principles
- 2 Courthouse Organization
- 3 Site Design
- 4 Courthouse Security
- 5 Court Set

**6 JURY FACILITIES
AND COURT
ADMINISTRATION**

- 6.A Jury Facilities Objectives
- 6.B Jury Assembly Spaces
- 6.C Objectives of the Clerk's Office
- 6.D Clerk's Office Spaces
- 6.E Court Executive Officer's Area

- 7 Special Services
- 8 In-Custody Defendant Receiving, Holding, and Transport
- 9 Public Spaces
- 10 Building Support Services

- f. Design workstations to accommodate communication and electronic equipment and storage space. Provide space for dual monitors on the desk. Configure and provide all counter stations with power and data to allow cash and credit card transactions. Include outlets for a credit card swipe machine, a printer, a cash drawer, and cameras. Locations shall facilitate communication and passage of documents between clerks and the public. Attach the credit card swipe machine to the public side of the counter.
- g. Provide a silent duress alarm at each clerk counter position.
- h. See chapter 16, Lighting Criteria, for lighting suggestions.
- i. Provide permanent counter positions with a means of blocking the view from the public side when the staff member is off duty but still working in the position. Pull-down shades or movable screening devices are acceptable.
- j. Providing security with glass barriers is the preferred method to create a layer of separation between staff and the public.
- k. Provide voice transmission through 1-1/4" vertical slots or grills on either side of the window. Provide a pass-through tray.
- l. Avoid amplified acoustic systems to prevent a loud lobby environment. The lobby shall be designed with acoustic finishes for sound absorption. An amplification system may be considered on a case-by-case basis depending on the acoustic quality of the space and ambient noise.
- m. When a queuing area is provided in the public area outside the counter, allow 10' minimum between the public entrance and the counter for the public queuing area. Provide additional space near the queuing area for a public writing counter for forms preparation. When a "take-a-number" system is in use, provide adequate seating for the waiting public.
- n. Some public counters may be located on the nonsecure side of the security screening station. If counters for fast transactions, such as traffic and attorney filing, are located in the public lobby queuing area or outside, they must be protected with a glass barrier and cameras. Outside counters must be located under an overhang for protection from wind, sun, and rain and shall have an exterior-grade vandal-proof credit card swipe machine on the public side of the counter.
- o. Locate and design drop boxes for convenient public use. Locate drop boxes within the courthouse public spaces. Review location and design of all drop boxes regarding safety and security issues.
- p. Provide a counter for information and payment transactions for the revenue and collections office.

2. Records Viewing

- a. Provide an area adjacent to the public service counter for public viewing of records. This area must be secure and visible to staff at all times to prevent tampering with or theft of records. Records viewing sequence and operation should be clearly incorporated in the design.
- b. Space for self-service duplication equipment in the public area may be provided on the request of the court. Establish a reasonable ratio of public computers to the number of counter stations.

6.E COURT EXECUTIVE OFFICER'S AREA

Office needs for the court executive officer's area include an office for the court executive officer (CEO), a reception area, offices for support staff to the CEO, a conference room close to the CEO office, workstations for staff, and space for files and office equipment. A separate restroom for the CEO is not required. The CEO area can be separate from the main clerk's office and is often located on an upper level in multilevel courthouses or adjacent to the presiding judge's chambers.

1. Offices and Workstations

- a. Workstations and office furniture shall be modular to enable complete ergonomic and expansion flexibility. Provide medium workstations with overhead storage. Low partitions, at a height of 42", are encouraged for part of the enclosure, to promote communication and visibility to the public counter area. Some stations can be combined into a shared work area and shared central small conference area.
- b. See workstation size standards in table 2.2 of chapter 2, Courthouse Organization, and planning criteria below for each respective court division per its office area requirements.
- c. Provide space for:
 - Office equipment, files, storage, counters, and special work areas;
 - Visitors, meetings, training, reception, and waiting areas; and
 - Dedicated conference and meeting rooms, unless staff can share other meeting spaces.

2. Information Technology (IT)

Information technology administration functions include systems development, programming, information management, technical support, planning, and research operations. These functions are primarily nonpublic and require office and workstation environments. Larger jurisdictions maintain technical libraries, computer server equipment rooms, computer workrooms, and, occasionally, large mainframe computer operations.

- a. Provide an IT workroom and storage space with a 32" counter on two sides.
- b. Provide a 14" shelf 21" above the counter. This casework shall be plastic laminate finish.
- c. Above the counters, provide a continuous plugmold electrical unit. See chapter 17, Network and Communication Systems, for more information.

3. Purchasing

Office space needs for purchasing staff include small to large workstations for buyers or other support staff and a medium office for management. Consider a small conference space for meetings or negotiations with vendors.

4. Revenue and Collections

The revenue and collections office area requires standard workstations.

- a. Provide a public reception area and counter space for information and payment transactions.
- b. Provide counter workstation positions and space for files and office equipment.
- c. Provide space for multiple file cabinets for records and files.

DIVISION ONE: DESIGN CRITERIA

- 1 General Principles
- 2 Courthouse Organization
- 3 Site Design
- 4 Courthouse Security
- 5 Court Set
- 6 JURY FACILITIES AND COURT ADMINISTRATION
- 6.A Jury Facilities Objectives
- 6.B Jury Assembly Spaces
- 6.C Objectives of the Clerk's Office
- 6.D Clerk's Office Spaces
- 6.E Court Executive Officer's Area
- 7 Special Services
- 8 In-Custody Defendant Receiving, Holding, and Transport
- 9 Public Spaces
- 10 Building Support Services

- d. Consider providing separate storage with restricted access and a security camera for safety.

5. Human Resources

The human resources office area requires standard to large workstations.

- a. Provide space for multiple file cabinets for records and files and a conference space within or adjacent to the workstations.
- b. Provide duress buttons at public counters and at any staff work area used for employee termination.
- c. Provide acoustical separation of any public space and staff areas where confidential telephone and personal conversations occur.

6. Records Storage

Some jurisdictions distinguish between active and inactive records for file storage purposes. *Active records* include open or regularly accessed files that are generally stored adjacent to the court clerk work areas. Active records are often maintained in indexed, open shelving units for easy access. *Inactive records* are often stored at a more remote location. Typically, three to four years of records are maintained onsite. A destruction program, if available, can help control growth of records storage.

- a. The design shall take into account the extent to which the court has transitioned from paper files to electronic files, since this has a big impact on space needs. This analysis shall be done during the Programming phase.
- b. Records must be maintained, pulled on request, routed, and interfiled.
- c. Provide space for scanning documents for storage and to accommodate future records storage and retrieval technologies. Floors must be designed to accommodate file weight. Provide minimum aisle widths of 36".
- d. See chapter 16, Lighting Criteria, for lighting suggestions.
- e. Posttrial exhibit storage should be provided in a secure central location adjacent to secure clerks' offices.

7. Active Records Storage

- a. Active records must be easily accessible from the clerk's office work areas and in a secure location. Functional requirements and policies of each courthouse will influence the location of the active file storage area; the ground floor is preferred because of structural load issues.
- b. Verify the functional and space requirements for active record storage to provide sufficient space. Include adequate workspace adjacent to the file storage equipment.
- c. High-density record storage is preferred for most active file storage because of the smaller footprint but cannot be used in departments requiring constant file retrieval. Motorized systems are preferred, but manual systems may be acceptable for infrequently accessed high-density files. Design with some fixed aisles so several aisles can stay open for staff access. Specify record storage seven shelves high.
- d. A locking feature may be used to secure confidential files.

8. Inactive Records Storage

If inactive files are stored onsite, an adequate and accessible storage area must be provided. Spatial requirements will vary in accordance with the number of records and the length of file retention schedules.

- a. Older inactive records should be stored offsite to economize on use of courthouse space.
- b. Warehouse shelving is recommended for files that have been transferred to storage boxes.
- c. Protect the file storage medium against deterioration or damage from flooding or moisture.

9. Conference and Training Rooms

- a. Provide conference rooms that allow judges, court managers, and staff to gather regularly for bench meetings, education and training, and administrative meetings. The three conference room sizes listed in table 2.2 do not preclude larger conference rooms in large court buildings or combining of multiple rooms with folding walls.
- b. Provide small conference rooms adjacent to workstation areas. Sharing of conference and training rooms between departments is encouraged.
- c. Provide a training room, located for easy accessibility by staff. Design the room for flexibility, with multipurpose furniture and a projection screen to accommodate training, conferences, and other meetings. See chapter 16, Lighting Criteria, for lighting requirements and chapter 18, Audiovisual Systems, for audiovisual requirements.
- d. Locate training rooms in private circulation areas. One entrance to a training room shall be accessible only by court personnel and judicial officers through a private corridor. A second entrance may be accessible via a public corridor.
- e. To determine the size of a training room, use the following guidelines:
 - Computer training layout: 35–40 square feet (SF) per person
 - Hollow square layout: 30 SF per person
 - Classroom-style layout: 20–22 SF per person
 - Theater-style layout: 10–12 SF per person
- f. In addition to the recommendations above, when allocating space for training rooms, take into consideration other factors, including:
 - Availability of other training spaces in the area;
 - Distance between other justice centers;
 - Number of employees and judges in the area;
 - Largest anticipated internal event, frequency of such events, and availability of space to accommodate these types of events;
 - Average number of attendees for regularly offered training courses and meetings, and frequency of these types of trainings and meetings;
 - Anticipated demand for technical training; and
 - Ratio of open office space to private offices to help determine the demand for private meeting spaces.

DIVISION ONE: DESIGN CRITERIA

- 1 General Principles
- 2 Courthouse Organization
- 3 Site Design
- 4 Courthouse Security
- 5 Court Set
- 6 JURY FACILITIES AND COURT ADMINISTRATION
- 6.A Jury Facilities Objectives
- 6.B Jury Assembly Spaces
- 6.C Objectives of the Clerk's Office
- 6.D Clerk's Office Spaces
- 6.E Court Executive Officer's Area
- 7 Special Services
- 8 In-Custody Defendant Receiving, Holding, and Transport
- 9 Public Spaces
- 10 Building Support Services

10. Mail Center

Provide an area for intake, sorting, and distribution of mail. See chapter 4, Courthouse Security, for main room physical security design standards. Large facilities may require an additional area for mechanical and electrical components to support heating, ventilation, and air-conditioning (HVAC) biofiltration systems.

11. Other Support Areas

Other support areas may include copy facilities, supply rooms, restrooms, and break areas.

- a. Provide printer/copier areas to accommodate high-volume copying. They shall be ventilated to dissipate copier heat and fumes and located to minimize noise disruption of other work areas. Depending on the size of the court facility and workload, convenience copiers may be located throughout the building.
- b. Provide an area with adequate shelving and work areas for storing office supplies.
- c. Allocate space for employee restrooms. Consider current and projected future staff composition when determining the number of toilet fixtures. Additional restroom facilities for female employees may be required.
- d. Provide a staff break room with a sink, disposal, and casework. The court and/or its employees shall provide appliances.
- e. Provide an employee lactation room in close proximity to employee workstations as required by California and federal laws and the California Building Code. The lactation room shall include a sink, space for a refrigerator, and easily accessible power outlets. The number of lactation rooms in the building shall be based on the number of employees as outlined in California and federal law.

12. Equipment Storage

Provide a locked area for equipment storage, including computer equipment.

DRAFT

7

DIVISION ONE: DESIGN CRITERIA

SPECIAL SERVICES

SECTION	TOPIC	PAGE
7.A	Objectives	7.2
7.B	Family Law Facilitators and Services for Self-Represented Litigants	7.2
7.C	Family Court Services	7.4
7.D	Child Waiting Room (Optional)	7.6
7.E	Alternative Dispute Resolution	7.7
7.F	Multipurpose Rooms and Offices	7.7
7.G	Lactation Rooms	7.8



Family Justice Center Courthouse, County of Santa Clara
San Jose, CA
Zimmer Gunsul Frasca LLP

Family law facilitators guide litigants through the forms and procedures related to child support, spousal support, and maintenance of health insurance. They assist with cases involving the local child support agency, many of which are cases requiring reimbursement for public assistance. Many facilitators are involved in community outreach programs.

Facilitators provide mediation services, in which they meet with both parents and help work out child support issues. Some courts have enlisted volunteer attorneys or provided additional funding that enables facilitators to assist self-represented litigants in other family law areas, including divorce, custody, and visitation.

Task Force on Self-Represented Litigants, highlights from *Statewide Action Plan for Serving Self-Represented Litigants*.

FCS = Family Court Services

ADR = alternative dispute resolution

Family law facilitators, self-help centers, Family Court Services (FCS), juvenile dependency mediation, child waiting, and alternative dispute resolution (ADR) programs promote the effectiveness and efficiency of certain types of court cases. Through the use of these services, the litigant has better information, issues are settled more frequently, court appearances are minimized, and paperwork is reduced.

Related justice agencies (i.e., district attorney, public defender, probation, Child Protective Services) have significant business each day within the trial court. Temporary spaces for related justice agencies may be considered.

7.A OBJECTIVES

- a. The spaces of special services must be convenient to the public and located off the public corridor or public waiting. These areas must also have access to the private circulation system.
- b. Ensure safety and security in the event of physical confrontation by means of duress alarms and sidelights at doors. Duress alarms shall be inconspicuous but convenient to the user. Facilitate future flexibility by providing these features in all spaces.

7.B FAMILY LAW FACILITATORS AND SERVICES FOR SELF-REPRESENTED LITIGANTS

Family law facilitator programs are a mandated service. Supervised by experienced family law attorneys, they provide self-help assistance to litigants with child support issues.

Most courts have expanded their family law facilitator activities to provide other self-help assistance in family law, and a growing number of courts provide self-help in other areas. In the *Statewide Action Plan for Serving Self-Represented Litigants*, prepared by the Task Force on Self-Represented Litigants and approved by the Judicial Council in 2004, attorney-supervised, staffed self-help centers are recommended for every court. Figure 7.1 shows the variety of case types that are self-represented by litigants.

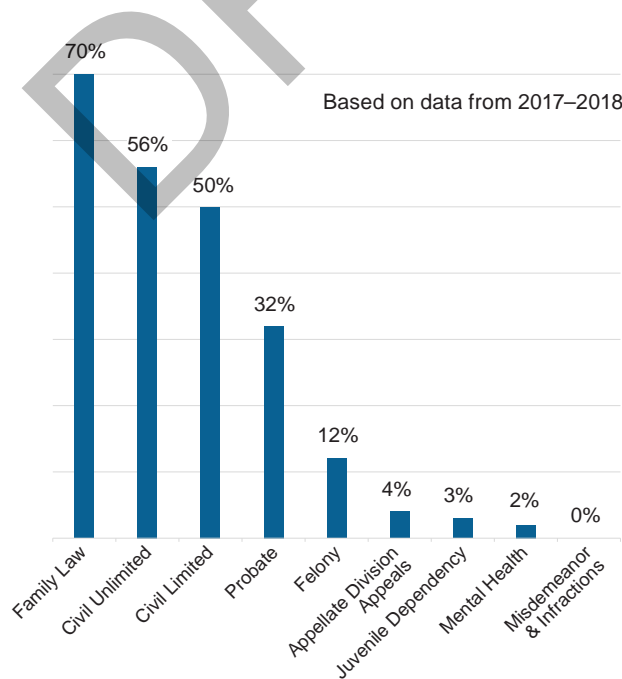

Figure 7.1 Self-Represented Litigants' Needs (by Case Type)

Family law facilitators and self-help centers provide assistance and practical information about court procedures for self-represented litigants using the court. Locate self-help centers near the clerks' offices, easily accessible from a public corridor. See figure 7.2.



Figure 7.2 Self-Help Center, the Robert M. Falasco Justice Center, Superior Court of Merced County, Los Banos

1. Reception, Waiting, and Triage Areas

- a. Provide public waiting areas for users and children, with child waiting, reception counter, and triage areas. These areas experience an extremely high volume of usage. In large courts, seating should be available for 30 to 50 people.
- b. Provide small tables that can be reconfigured for classes, for filling out forms or for conferencing; computer terminals located against the wall; and brochure racks, shelving, storage, video monitors, and a photocopier.
- c. Provide staff workspace with file storage, work counters, and equipment. Public counters and reception areas may be integrated into the work areas.
- d. Provide a duress alarm at counters.

2. Workshop Rooms

- a. In jurisdictions with more than one family law facilitator, provide a workshop room. The room must accommodate reference materials, audiovisual equipment for workshops, and computers to allow litigants to complete forms. See chapter 16, Lighting Criteria; chapter 17, Network and Communication Systems; and chapter 18, Audiovisual Systems, for technical requirements.
- b. In jurisdictions with at least one full-time facilitator, provide at least one conference room for services to be provided by volunteer attorneys, paralegals, and other staff supervised by the attorney facilitator or self-help center attorney's office.
- c. Provide one private office per facilitator and staff attorney. If separate interview or conference rooms are not provided for mediation, the private offices should be large enough to accommodate up to five people for this purpose.
- d. Provide a duress alarm in offices and at counters.

3. Small Courthouse Model

Provide one room designed so that one staff member can provide supervision and control.

DIVISION ONE: DESIGN CRITERIA

- 1 General Principles
- 2 Courthouse Organization
- 3 Site Design
- 4 Courthouse Security
- 5 Court Set
- 6 Jury Facilities and Court Administration

7 SPECIAL SERVICES

- 7.A Objectives
- 7.B Family Law Facilitators and Services for Self-Represented Litigants
- 7.C Family Court Services
- 7.D Child Waiting Room (Optional)
- 7.E Alternative Dispute Resolution
- 7.F Multipurpose Rooms and Offices
- 7.G Lactation Rooms

- 8 In-Custody Defendant Receiving, Holding, and Transport
- 9 Public Spaces
- 10 Building Support Services

Each court should endeavor to provide a children's waiting room located in the courthouse for the use of minors under the age of 16 who are present on court premises as participants or who accompany persons who are participants in court proceedings. The waiting room should be supervised and open during normal court hours. If a court does not have sufficient space in the courthouse for a children's waiting room, the court should create the necessary space when court facilities are reorganized or remodeled or when new facilities are constructed.

California Standards of Judicial Administration, standard 10.24

4. Information Shared Outside Courtroom

Provide a brochure rack and video feed outside the family courtrooms to instruct users on courtroom procedures.

7.C FAMILY COURT SERVICES

1. Requirements

Courts are required to set contested child custody and visitation issues for mediation. Family Court Services provides mediation, which must include a mandatory orientation as well as a mandatory intake process that screens for, and informs staff about, any restraining orders, dependency petitions under Welfare and Institutions Code section 325 et seq., and other safety-related issues affecting any party or child named in the proceedings. Rule 5.215 of the California Rules of Court requires FCS to conduct differential domestic violence assessments; make reasonable efforts to ensure the safety of victims, children, and other parties when they are participating in services provided by FCS; and, consistent with Family Code sections 3113 and 3181, offer separate mediation sessions at separate times when there is a history of domestic violence or when a protective order as defined in Family Code section 6218 is in effect, or if domestic violence is discovered while mediation or evaluation services are in process. A domestic violence support person may accompany a party protected by a restraining order to mediation and orientation. In child custody and visitation cases, FCS may also offer appropriate services as available, such as child custody evaluation, parent education, relevant education programs for children, booklets, DVDs, or referrals to community resources. FCS offices also commonly offer such services as stepparent adoption, conservatorship, and guardianship investigations.

The Family Court Services mediation area can generate considerable traffic flow. Locate FCS on a lower floor close to the main lobby or near elevators on an upper floor. Other civil mediation and arbitration services do not generate the same traffic load as FCS and may be located away from the main lobby. Parties using FCS often also use family law facilitator / self-help services; locating these services nearby would be helpful to the public. If possible, provide more than one exit from FCS to have alternative access for domestic violence victims who are participating in mediation.

2. Facilities

Family Court Services consists of the following areas:

- Mediator and evaluator offices
- Reception and waiting areas
- Orientation room
- Mediation room
- Conference and training room
- Children's waiting area
- Security station
- Equipment storage

For sizes, refer to table 2.2 in chapter 2, Courthouse Organization.

2.1 Mediator Offices

- a. Provide a private office for each mediator, to accommodate three additional people. If separate mediation/interview rooms are not provided for larger mediations, private offices shall accommodate up to six people.
- b. Provide sidelights at office doors.
- c. Provide acoustical treatment of office walls and doors.
- d. Provide a duress alarm in each office, because of the potential for physical confrontation.

2.2 Reception and Waiting Areas

- a. Provide reception and waiting areas with seating sized for the court's needs.
- b. Provide a vision panel at the suite entry door.
- c. In large jurisdictions, provide a reception counter and sign-in area, with a counter position.
- d. Provide duress alarms in support staff areas and at counters.
- e. Provide an area for copy and fax machines adjacent to clerical staff and mediators.
- f. Provide space for FCS files and records adjacent to clerical staff.
- g. Provide a reception area with sufficient space to accommodate mandatory screening, intake, and differential assessment. Private space should be available to allow for safe consultations with vulnerable parties, such as victims of violence.
- h. If possible, provide separate waiting areas for different parties in mediation. One or two reception and waiting areas will serve several mediation offices. Separate FCS waiting areas should be available for domestic violence victims, so that they do not have to be in the same area as the alleged perpetrators.

2.3 Orientation Room

Provide an orientation room with seating for four to six people for orientation sessions before participation in mediation or other ADR services. This room can also be used for additional waiting and conferencing.

2.4 Mediation Room

- a. Provide a mediation room. In some jurisdictions, a combination of large and small mediation rooms will accommodate large family groups and allow involvement of social workers and other staff. This room can also be used for interview purposes.
- b. Provide acoustical treatment of office walls and doors, because of the confidential and sometimes vocal exchanges associated with these discussions.
- c. Provide a duress alarm.
- d. Provide video cameras to allow remote observation of proceedings.

2.5 Conference and Training Room

In jurisdictions with more than eight FCS mediators, provide a conference and training room of a size proportionate to the number of mediators. The room must accommodate reference books and related materials needed by mediators to conduct their business. One room may be used for mediation, orientation,

DIVISION ONE: DESIGN CRITERIA

- 1 General Principles
- 2 Courthouse Organization
- 3 Site Design
- 4 Courthouse Security
- 5 Court Set
- 6 Jury Facilities and Court Administration

7 SPECIAL SERVICES

- 7.A Objectives
- 7.B Family Law Facilitators and Services for Self-Represented Litigants
- 7.C Family Court Services
- 7.D Child Waiting Room (Optional)
- 7.E Alternative Dispute Resolution
- 7.F Multipurpose Rooms and Offices
- 7.G Lactation Rooms

- 8 In-Custody Defendant Receiving, Holding, and Transport
- 9 Public Spaces
- 10 Building Support Services

conferences, and training. See chapter 16, Lighting Criteria, and chapter 18, Audiovisual Systems, for audiovisual requirements. Provide a duress alarm.

2.6 Children's Waiting Area (Optional)

If no other children's waiting area is available or convenient, provide a separate children's waiting area near FCS to be used when children or their parents or guardians are involved in court proceedings. See figure 7.3 and refer to 7.D, Child Waiting Room (Optional), for standards for this area.

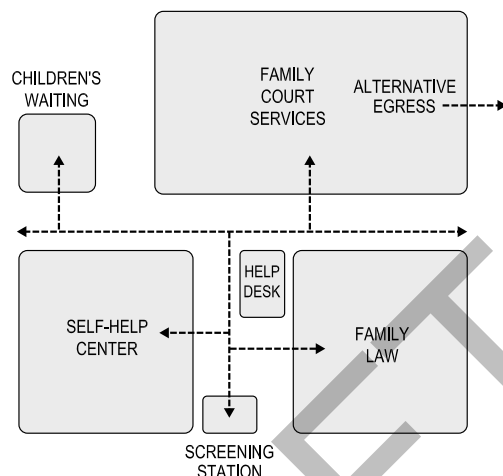

Figure 7.3 Special Services Adjacency Diagram

2.7 Security Station

Security provisions for the FCS area vary based on the size and location of the function. If remote from the court security staff, the FCS area may require a separate security post. If the security staff is stationed at FCS, provide a post with workstation and security equipment.

2.8 Equipment Storage

Provide an area near the mediation rooms for storage of equipment and furnishings, such as video monitors, used in mediation.

7.D CHILD WAITING ROOM (OPTIONAL)

In all court facilities, endeavor to provide a safe place for children to play—including a child waiting room—while their parents conduct their court business.

- Provide an area of 120 net square feet (NSF) for two or three children, increasing the area by 15 NSF per child. The waiting area must be located near the security station but in a semiprivate corridor. Space needs will vary with court caseloads. Consider providing separate areas for adolescents.
- Provide a check-in workstation with a duress alarm and a view of the entire room, to allow supervision by one staff person; design must facilitate safe check-in and checkout of children. Include file storage for administrative records, forms, and brochures.
- Do not allow outside visual access or windows; the public shall not be able to look into the room.
- Provide a controlled area for the children. Access doors shall be locked with a remote buzzer operated from the check-in workstation.
- Provide one or two restrooms, one with a changing table.

- f. Provide a second door into a secure corridor. Small facilities can use a multipurpose room.
- g. Provide space for child-sized tables, chairs, couch, and floor games, and storage space for toys and games.
- h. Provide space for information racks about community resources for service referrals and other resources (housing, health care, childcare, literacy, and education).
- i. Provide a quiet room with a sink, locking cupboards, a refrigerator, and a microwave.

7.E ALTERNATIVE DISPUTE RESOLUTION

Alternative dispute resolution services are an increasingly important part of the judicial process. In the civil case context, ADR includes the traditional civil case settlement process involving a judicial officer, attorneys, and the litigants; mediation, involving a facilitator and the parties, sometimes without attorneys; and arbitration, involving an arbitrator, attorneys, and the litigants.

1. Mediation and Settlement Conferences

Civil case mediation and arbitration services may be provided privately and occur outside the court facility. Civil case settlement conferences often take place in a courtroom, jury deliberation room, or conference area. Court-sponsored mediation, such as in small claims and unlawful detainer cases, may be provided in court facilities.

Provide space for civil case settlement conferences and mediation services within the court facility when required by the program. Requirements for these functions may vary considerably depending on anticipated volume of usage. In larger jurisdictions with formal ADR programs, consider multiple rooms of various sizes and capacities. For sizes, refer to table 2.2. Space for these functions may include reception and waiting areas.

2. Reception and Waiting

If required by the program, provide an area with seating for six to eight people, where attorneys and litigants can be seated while waiting for a mediation room. This area can serve one to four mediation rooms and may be increased in size according to the number of additional mediation rooms required.

7.F MULTIPURPOSE ROOMS AND OFFICES

1. Guidelines

- a. Provide multipurpose rooms, to be assigned by the trial court to related justice agencies or others. The character and quantity of rooms shall be determined during programming.
- b. Locate rooms adjacent to the public corridor, potentially with controlled access to the private circulation system; provide keypad locking so the superior court can reassign the use easily.

2. Examples of Room Use

Representative uses of multipurpose rooms include:

- Related justice agency drop-in offices: Rooms suitable for installation of modular workstations, for staff use to prepare and read court papers, make telephone calls, and conduct other court-related activities.
- Onsite drug testing suite: A toilet room used for drug testing adjacent to the courtroom, with an anteroom for supplies and sample storage.

DIVISION ONE: DESIGN CRITERIA

- 1 General Principles
- 2 Courthouse Organization
- 3 Site Design
- 4 Courthouse Security
- 5 Court Set
- 6 Jury Facilities and Court Administration

7 SPECIAL SERVICES

- 7.A Objectives
- 7.B Family Law Facilitators and Services for Self-Represented Litigants
- 7.C Family Court Services
- 7.D Child Waiting Room (Optional)
- 7.E Alternative Dispute Resolution
- 7.F Multipurpose Rooms and Offices
- 7.G Lactation Rooms

- 8 In-Custody Defendant Receiving, Holding, and Transport
- 9 Public Spaces
- 10 Building Support Services

- Attorney convenience center: A work and waiting area, with power and data communications for laptop connections, similar to drop-in offices for related justice agencies.
- Multiagency and volunteers convenience center: Workstations for volunteers.
- Volunteer coordinator's office: In larger counties with comprehensive or centralized volunteer programs, a coordinator's office. May be located on a semiprivate corridor. Volunteers may also be located within specific court departments.
- Law enforcement waiting: A waiting area that must be located off public corridors near courtrooms and may be provided in criminal, traffic, and juvenile courts in which law enforcement officers may wait before court appearances and during court recesses. Access to the law enforcement waiting area must be secure and away from the public corridor. The waiting area must include space for a couch, chairs, lounge seating, and a table.
- Victim waiting: A waiting area located off public corridors near courtrooms, with chairs and a table. This room may be used for remote testimony to the courtroom. Provide power, lighting, and configuration to allow audiovisual equipment to obtain proper images for victim to testify remotely.
- Court interpreters convenience center: A waiting area located off public corridors near courtrooms. The convenience center requires a bullpen with adequate space for lockers, carrels, tables, manager's office, shared phones, secure storage, and a telecommunications device for the deaf (TDD).
- Blood draw / DNA swab room: A room at family court with a chair and locked cabinet.
- Fingerprinting: An area adjacent to criminal court, with a secure door. Provide a pass-through to the family law clerk's area. Provide a desk and a camera area to take headshot photos.
- Government attorneys conference room: A large conference room with computers and printers available to calculate child support and print out agreements. Local child support agencies often meet with litigants before and during the high volume of child support calendars to try to reach stipulations.
- Paralegal office: A drop-in center to assist families with child support issues, requiring room for a desk, file storage, and three or four guest chairs.
- Social services resource room: A room located near courtrooms so that litigants who are referred to social services can get immediate assistance for problems such as substance abuse.

7.G LACTATION ROOMS

Provide one lactation room for the public and one lactation room for court employees. Lactation rooms cannot be in a bathroom; they require their own dedicated space.

1. General Requirements

- a. The lactation rooms shall be shielded from view and be free from intrusion while in use.
- b. The rooms shall include a sink with running water.
- c. The space shall be safe, clean, free of hazardous materials and shall contain a built-in shelf on which to place personal items. The room shall have space for a movable chair with adequate ADA accessibility clearances.

- d. The room shall include electrical outlets to operate lactation equipment.

2. Public Lactation Room

- a. The public lactation room is available to visitors of the court facility and shall be accessed from the public corridor.
- b. The court shall have a policy in place for lactating mothers to reserve the room when needed. Signage outside the room shall include information on how to reserve the room.

3. Employee Lactation Room

- a. The employee lactation room is available to court employees and shall be accessed from the secure corridor.
- b. The lactation room shall be located in close proximity to the work area of the majority of court employees.
- c. The room shall include space and hookups for a refrigerator.

DRAFT

DIVISION ONE: DESIGN CRITERIA

- 1 General Principles
- 2 Courthouse Organization
- 3 Site Design
- 4 Courthouse Security
- 5 Court Set
- 6 Jury Facilities and Court Administration

7 SPECIAL SERVICES

- 7.A Objectives
- 7.B Family Law Facilitators and Services for Self-Represented Litigants
- 7.C Family Court Services
- 7.D Child Waiting Room (Optional)
- 7.E Alternative Dispute Resolution
- 7.F Multipurpose Rooms and Offices
- 7.G Lactation Rooms

- 8 In-Custody Defendant Receiving, Holding, and Transport
- 9 Public Spaces
- 10 Building Support Services

DRAFT

DIVISION ONE: DESIGN CRITERIA

8

IN-CUSTODY DEFENDANT RECEIVING, HOLDING, AND TRANSPORT

SECTION	TOPIC	PAGE
8.A	Objectives	8.2
8.B	Planning Criteria	8.2
8.C	Functional Overview	8.3
8.D	Program Components	8.5
8.E	Technical Criteria	8.13
8.F	Electronic Detention Control System	8.25



Superior Court of California, County of Shasta
Redding, CA
NBBJ

Important Terms

Circulation: Public, Private, Detention

Control Rooms: For more information, see 4.H.14, Security Operations Center, and 8.D.4, Detention Control Room.

In-custody(ies): Persons in the custody of a correctional or detention institution

Detention and holding are used interchangeably in this chapter.

This standalone chapter addresses the requirements for all in-custody areas and is organized as follows:

8.A: Objectives

8.B: Planning Criteria

8.C: Functional Overview

Describes relationships between in-custody transport and holding areas and other courthouse functions.

8.D: Program Components

Defines the functional scope, operational considerations, access, adjacency, and design considerations for specific program components.

8.E: Technical Criteria

Establishes minimal acceptable performance criteria for finishes, fixtures, and equipment.

8.F: Electronic Detention Control System

Establishes minimal acceptable performance criteria for the integrated security electronic systems.

The United States Constitution makes provision for defendants involved in criminal proceedings to confront the witnesses against them. Therefore, trial courthouse design and construction must provide accommodation for those defendants who are in custody. Criminal courts must have secure facilities to receive, hold, and transport in-custody defendants to and from the courtroom. In small court facilities, this requirement may amount to a few holding cells and a secure corridor to the courtrooms. In larger criminal court facilities, it may consist of a large receiving and detention facility. Similarly, civil, family, and juvenile court facilities must maintain safe and secure movement of in-custody defendants.

The information in this chapter provides each architectural and engineering team a perspective on how the in-custody receiving, holding, and transport functions integrate into the overall courthouse; a general description of the program components that pertain to these areas; and performance criteria for finishes, equipment, and security systems.

These standards are intended to supplement the requirements addressed in the regulations of the Board of State and Community Corrections, found in titles 15 and 24 of the California Code of Regulations. The design of all in-custody areas must adhere to requirements prescribed in titles 15 and 24 of the California Code of Regulations.

8.A OBJECTIVES

The objectives are to provide a safe and secure environment for the transport and accommodation of in-custody defendants while in the courthouse; to maintain the safety and welfare of the judiciary, staff, and public visitors in the building; and to prevent the infiltration of contraband.

The local sheriff, under contract with the superior court, manages all in-custody holding and transport areas and operates the security electronic systems relating to the in-custody holding, detention, transport, and detention circulation areas within the courthouse.

- a. Every design solution must optimize operational and staffing efficiencies.
- b. Although these standards establish criteria for the in-custody holding area, during the design process the sheriff must also provide an Operational Program Statement as required by the Board of State and Community Corrections (BSCC). The design and the Operational Program Statement are developed together and influence one another.
- c. All in-custody areas shall comply with detention standards subject to BSCC inspection and certification under California Code of Regulations, title 15. The Detention area design shall provide safety for in-custody defendants, sheriffs, and others and be consistent with the sheriff's Operational Program Statement.

8.B PLANNING CRITERIA

From a physical security standpoint, several basic rules of thumb apply to the design of secure holding and circulation areas:

- Maximize the direct line of sight, allowing the court security officer (CSO) to supervise in-custodies and to minimize reliance on video surveillance cameras.
- In detention circulation areas and corridors, minimize protrusions that create blind spots.
- Organize functional components to avoid circulation “eddies.” The in-custody holding areas are process driven. Designs must achieve a logical flow for managing the process, movement, and separation of in-custody defendants.

Local sheriffs will have protocols, or a classification system, for how they manage the separation of individuals in custody. Classification determines if it is appropriate to accommodate an individual in a group holding cell or if a single holding cell is required for the safety of the in-custody and those around the in-custody. The separation or isolation of an in-custody can be based on a number of factors, such as the in-custody’s being a danger to others or requiring protection from others. Separate holding areas are typically preferred in maintaining the separation of males and females in custody.

1. Sight and Sound Separation

Under some circumstances, juveniles in custody must be present at court proceedings. Provisions must be made in the design of holding areas to maintain “sight and sound separation” between in-custody juveniles and in-custody adults. In-custody juveniles should not come into contact with in-custody adults as they enter, are held in, and circulate to and from the courtrooms during the course of normal operations. Together, the building plans and Operational Program Statement must demonstrate a good-faith effort to maintain the required separation through the course of foreseeable circumstances.

Several design features are inherent with accomplishing proper sound and sight separation.

- a. Central holding must have separate areas for juveniles and adults. It is not enough to have separate cells accessed from the same corridor.
- b. Access to adult and juvenile holding areas from the vehicular sally port should be separate. A single, centrally controlled pedestrian sally port does not violate this principle, but to circulate juveniles or adults through the other’s holding area to reach their own is unacceptable.
- c. Design in-custody elevators and shared detention corridors such that detention control can coordinate their use to reliably clear one group before use by another.

2. Acoustics Management

The acoustics of holding areas shall be managed appropriately.

- a. For security and durability reasons, materials in the holding areas result in “hard” surfaces. Special care must be taken to manage the acoustics. Minimizing reverberation within in-custody holding and transport areas is essential in reducing stress among in-custody defendants and staff.
- b. The design solution must prevent the transmission of sound from a central holding area into any adjacent departmental areas. Most critical is to prevent the transmission of sound between courtroom holding areas and the courtroom. Acoustical requirements are defined in chapter 19, Acoustical Criteria.

8.C FUNCTIONAL OVERVIEW

The business of the courts includes motions, hearings, and trials involving in-custody defendants. Courthouses do not include provisions for booking in-custody defendants because this procedure typically occurs at a detention facility before transporting the defendant to the courthouse. Therefore, courthouses must provide safe and secure accommodations for receiving individuals coming from secure detention facilities; for holding them before their courtroom appearances; and for moving them to and from the courtroom itself. Courthouse detention facilities do not house in-custody defendants overnight; they are present in the courthouse only during the normal hours of operation for the court.

DIVISION ONE: DESIGN CRITERIA

- 1 General Principles
- 2 Courthouse Organization
- 3 Site Design
- 4 Courthouse Security
- 5 Court Set
- 6 Jury Facilities and Court Administration
- 7 Special Services
- 8 IN-CUSTODY DEFENDANT RECEIVING, HOLDING, AND TRANSPORT**
 - 8.A Objectives
 - 8.B Planning Criteria
 - 8.C Functional Overview
 - 8.D Program Components
 - 8.E Technical Criteria
 - 8.F Electronic Detention Control System
- 9 Public Spaces
- 10 Building Support Services

Important Term

Sally port: A secure, controlled entryway.

Important Design Elements

The secure perimeter is a physical barrier that prevents the unauthorized and uncontrolled movement of persons, contraband, and weapons into or out of in-custody areas.

Space allocations for detention functions within the building include holding cells, both centrally located and on the courtroom floors, and a system of dedicated elevators and/or corridors contained within the secure perimeter of the in-custody holding and transport areas. Standards require that all court facilities provide a secure pathway for in-custody movement from the transport vehicle, through pedestrian sally ports, to holding areas and the courtroom—using dedicated circulation to avoid cross-circulation with judges, staff, and the public.

1. Defendant Arrival

All transport vehicles delivering in-custody defendants access the courthouse proper through a secure vehicle sally port. Individuals are escorted from the vehicle sally port into the facility through a pedestrian sally port. For in-custody defendants escorted on foot (e.g., from a colocated detention facility), the entrance includes a pedestrian sally port that provides direct, controlled access to the secure circulation on the courthouse side.

In-custody defendants proceed to the central holding area (directly from the pedestrian sally port or through secure circulation), where paper check, pat search, and/or staging may occur before they are placed in a holding cell.

2. Holding

- a. Provide both individual and group holding cells to allow for containment of various in-custody populations and for efficient grouping and movement to the designated holding cells located on the courtroom floors. The area must be configured to provide for required sight and sound separations of cells and related circulation paths.
- b. The number, size, and configuration of holding cells will vary based on the type of courthouse and/or the scale. For example, small facilities (one to four courtrooms) may not need both central holding and courtroom holding cells because volume and physical proximity may allow for in-custody defendants to be moved directly from the sally port into courtroom holding cells. Large, multistory facilities, however, need a designated central holding area to manage the influx of what could be hundreds of in-custody defendants daily, and to manage their movement from central holding to the courtroom holding cells distributed on the courtroom floors.
- c. When court call approaches, in-custody defendants move from the central holding area to the courtroom holding cells located immediately adjacent to the courtrooms. Movement shall be via a secure, dedicated elevator and/or corridor, and defendants may or may not be escorted.
- d. Larger facilities may have courtrooms that are dedicated to special dockets, such as arraignment, felony disposition, drug court, pretrial hearings, and family and civil court cases. In smaller courthouses, a single courtroom may be used for arraignment for part of the day and for trials or hearings the rest of the day. Although different courtroom types may present different courtroom holding needs, courtroom holding should be provided between each pair of courtrooms in a shared “core.” The core space shall include individual holding cells, noncontact attorney-client interview rooms, sound-lock vestibules into each courtroom, and a dedicated secure elevator stop, if applicable.
- e. If adjacent courtroom holding is not provided for courtrooms initially designated for civil cases (which typically do not require courtroom holding), the space should presumptively be configured (horizontally and vertically) so that holding could be added between a pair of these courtrooms, if the designation changes.
- f. For courts that have high-volume in-custody access and have rapid case turnover, such as arraignment court, consider locating larger holding areas adjacent to the courtroom, or locate the courtroom adjacent to central holding, thereby eliminating the

intermediate step of dedicated courtroom holding altogether. If not possible, locate these courtrooms as close as possible to the central holding area (i.e., in larger courthouses, locate arraignment courts on lower floors closer to basement-level central holding) to minimize the transport time and travel distance for the large numbers of in-custody defendants.

- g. At the conclusion of the courtroom proceeding, in-custody defendants are returned to the central holding area to await transport back to the detention center. Based on local preference and demand, remand cells may be designated for individuals who came to court on the public side but have been remanded to jail as a result of the hearing.

8.D PROGRAM COMPONENTS

1. Secure Perimeter

The secure perimeter is a physical barrier between in-custody holding and transport areas and the building exterior and/or other nondetention departmental areas within the courthouse. The secure perimeter prevents the unauthorized and uncontrolled movement of persons, contraband, and weapons into and out of in-custody areas. An access control point (sally port) facilitates the movement of authorized persons between the secure and nonsecure sides of the secure perimeter barrier. The secure perimeter barrier comprises maximum-security construction for partitions (full-height, slab-to-slab), windows, doors, and floors; security bars at any vertical and/or horizontal penetrations 5" or larger in any direction; and sally ports at all access points.

2. Vehicle Sally Port

Vehicular access to the courthouse proper is via an enclosed vehicle sally port. A "drive-through" vehicle sally port is preferred, but not all sites and building configurations will be able to accommodate one. The optimal configuration must be determined on a project-by-project basis. (See figure 8.1.)

- a. In all cases, the vehicle sally port must be of secure construction and must minimize views into and out of the vehicle sally port area.
- b. The vehicle sally port must be designed with careful consideration of traffic flow and vehicle turning radii; backing maneuvers and three-point turns for large custody vehicles are to be avoided.
- c. Provide a secure access gate at the entry point, a second egress gate, and a personnel gate. The vehicle sally port gates shall be interlocking and able to be electronically monitored and controlled at the detention control room. The primary means of communication and coordination between an arriving in-custody transport vehicle and the detention control room is via radio. However, provide an audio call station/pedestal for outside agency use. Include video monitoring at access and egress points. Access and egress gates and doors shall be detention grade and must be sized (width and height) to accommodate the largest transport vehicle expected (car, van, or bus).
- d. The vehicle sally port must provide adequate space for the temporary parking of transport vehicles for the loading and unloading of in-custody defendants. The number and type of transport vehicles to be accommodated in the vehicle sally port will vary by project. For example, courthouses that are adjoined to the primary detention facility by tunnel or secure walkway would have considerably less vehicular transport and may require no more than a few parking spaces for sedans. In a major criminal court facility located remotely from the jail, the vehicle sally port may require parking for several large-capacity vehicles, vans, and cars.

DIVISION ONE: DESIGN CRITERIA

- 1 General Principles
- 2 Courthouse Organization
- 3 Site Design
- 4 Courthouse Security
- 5 Court Set
- 6 Jury Facilities and Court Administration
- 7 Special Services
- 8 IN-CUSTODY DEFENDANT RECEIVING, HOLDING, AND TRANSPORT**
 - 8.A Objectives
 - 8.B Planning Criteria
 - 8.C Functional Overview
 - 8.D Program Components
 - 8.E Technical Criteria
 - 8.F Electronic Detention Control System
- 9 Public Spaces
- 10 Building Support Services

The functions of the detention control room and security operations center may be combined in small court facilities, depending on the Operational Program Statement provided by the local sheriff's department responsible for the security of both the holding areas and the overall courthouse.

When the functions of the detention control room and security operations center are combined, coordinate the detention control room requirements with the security operations center requirements prescribed in chapter 4, Courthouse Security.

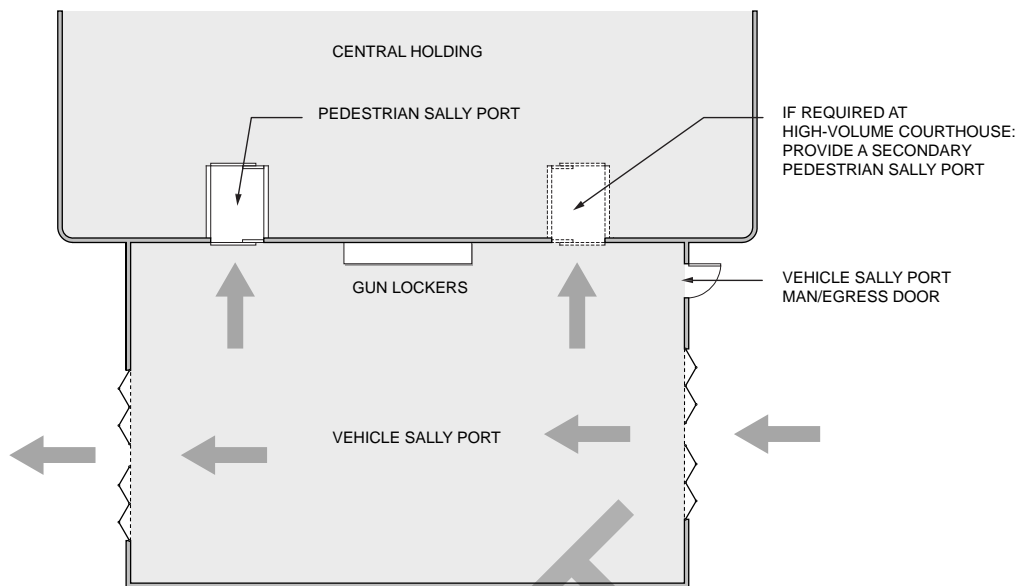

Figure 8.1 Vehicle Sally Port

- e. Provide a wall-mounted gun locker in the vehicle sally port for securing transport staff weapons outside the secure perimeter. Such weapons lockers shall be equipped with individual compartments, each with an individual locker device.
- f. Sight and sound separation of adult and juvenile in-custody defendants must be maintained at the point of reception in the vehicle sally port and into the building via the secure pedestrian sally port. This separation can be accomplished with a single pedestrian sally port. If required at a high-volume courthouse, provide a secondary pedestrian sally port dedicated to the movement of females and/or juveniles.

3. Pedestrian Sally Port

In-custody defendants are off-loaded from the transport vehicle in the vehicle sally port and escorted into the secure area of the courthouse via a pedestrian sally port. A pedestrian sally port is also required at all points of entry or egress into and out of the secure perimeter of the in-custody holding and transport areas. The pedestrian sally port provides control of movement to and from adjoining areas and prevents infiltration to these areas by unauthorized persons—or escape of in-custody defendants.

- a. The pedestrian sally port should have a minimum width of 8' determined by the custody agency's standard operating procedures regarding the maximum number of in-custodies allowed in one movement.
- b. The doors at each end of the pedestrian sally port are interlocked, meaning that one door must be in the locked position before the other can be opened. Pedestrian sally port doors are monitored and controlled by the detention control room staff. Provide a voice and video connection. Provide glazing to facilitate visual observation of the pedestrian sally port entry and within by the security staff.
- c. Pedestrian sally ports must meet secure perimeter construction requirements.

4. Detention Control Room

The detention control room is responsible for all circulation in and out of the secure perimeter of the secure transport and holding areas, detention circulation corridors for moving in-custody defendants to and from courtroom holding areas, and elevators dedicated

to in-custody movement. (See figure 8.2.) Detention control will control and monitor doors and locking devices, video surveillance systems, the duress alarm system, intercom and paging systems, lighting, and other functions dedicated to all in-custody secure holding and transport areas throughout the courthouse. Detention control has monitoring capabilities within the in-custody holding and transport areas for doors that are equipped with card access devices.

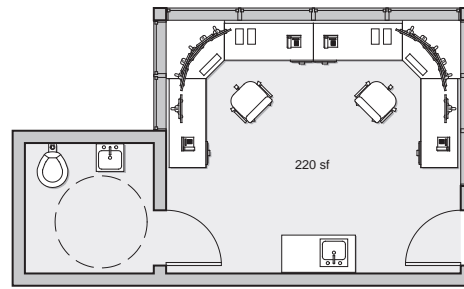

Figure 8.2 Detention Control Room

- a. The system's main point of control shall be located at the detention control. In larger courthouse facilities, the secure holding areas will have a dedicated control room (detention control) located within central holding.
- b. In courthouses with a segregated holding area for juveniles, a separate control station may be required for the juvenile section because juveniles are typically monitored and handled by probation officers, who are different personnel from the sheriff's department personnel who control the adult in-custody populations. This control station may be a desk with a control panel in the control room for probation officers to operate doors remotely within the juvenile area. In some cases, the local sheriff and probation departments may request that probation officers have a completely separate control room for the juvenile area.
- c. A separate security operations center for managing overall courthouse building security will be located elsewhere in the building, typically adjacent to the primary screening area in the main building lobby. Refer to chapter 4, Courthouse Security.
- d. Smaller courthouses may not warrant two separate control rooms. The goal of achieving staffing and operational efficiencies should be kept in mind. The functions of the detention control room and security operations center may be combined in small courthouses, depending on the Operational Program Statement provided by the local sheriff's department responsible for the security of both the holding areas and the overall courthouse. If a single central control room services the entire courthouse, the control room shall be located outside the secure perimeter of the in-custody holding areas. In such instances, the opening and closing of cell doors, operation of in-custody elevators, and other functions generally performed by the dedicated security personnel from the detention control room shall be managed from the single central control room.
- e. Whether the detention control room is within the in-custody holding area secure perimeter or elsewhere in the courthouse, it shall be constructed with security-grade partitions extending to the underside of the structure above. Access to the detention control room shall be limited and controlled by the detention control room itself. The detention control room should be inaccessible to in-custody defendants at all times. It should be equipped with a pantry station and a toilet room and must be accessible to persons with disabilities.
- f. When located within central holding, the control workstation within the detention control room shall be located so that the detention control officer has direct line of sight into holding areas and the main circulation areas within central holding. The line of sight must work from a seated position and be unobstructed by security equipment configurations.

DIVISION ONE: DESIGN CRITERIA

- 1 General Principles
- 2 Courthouse Organization
- 3 Site Design
- 4 Courthouse Security
- 5 Court Set
- 6 Jury Facilities and Court Administration
- 7 Special Services

8 IN-CUSTODY DEFENDANT RECEIVING, HOLDING, AND TRANSPORT

- 8.A Objectives
- 8.B Planning Criteria
- 8.C Functional Overview
- 8.D Program Components
- 8.E Technical Criteria
- 8.F Electronic Detention Control System

- 9 Public Spaces
- 10 Building Support Services

A sally port is required at any penetration allowing access in or out of the secure perimeter and shall be controlled by detention control.

- g. The detention control room environment must reduce stress and fatigue, as well as enhance the staff member's efficiency. Sound-absorbing material must be used to reduce sound reverberation and harshness of noise inside the room. Lighting design must reduce glare and reflection, with provision of a dimmer switch to control the lighting levels.
- h. The detention control room will be equipped with workstations that accommodate all equipment associated with monitor, control, and surveillance functions. The number of control workstations will be determined on a project-by-project basis. Control workstations should be flexible to accommodate the integration of future technologies and shall integrate wires and cabling within an enclosed, accessible housing. The use of modular or systems furniture is preferred. An ergonomic layout is very important. Monitors for video, productivity applications, and detention control should be uniform in size and mounted on articulating arms.
- i. Only electronic devices related to the user interface layout are accommodated at control workstations. The programmable logic controller (PLC) equipment, servers, and supporting equipment must be located in a nearby technology closet or main distribution frame (MDF) or intermediate distribution frame (IDF) room; access to the technology closets shall be located outside the in-custody secure perimeter. An equipment room dedicated to housing the electronic detention control systems is not required.

5. Central Holding

In-custody defendants are detained in a secure central holding area pending transport to the courtroom floor. Both individual and group holding cells are provided in this area, allowing for separation of juveniles and separation by gender. Several factors influence the number of central holding cells required. Where the courthouse is connected to a jail, for example, in-custody defendants can be escorted to the court more frequently and in smaller groups. The number of vehicular court transports—morning and afternoon runs or once a day—can also reduce the amount of central holding space required, which is some of the costliest construction in the building. (See figures 8.3–8.5.)

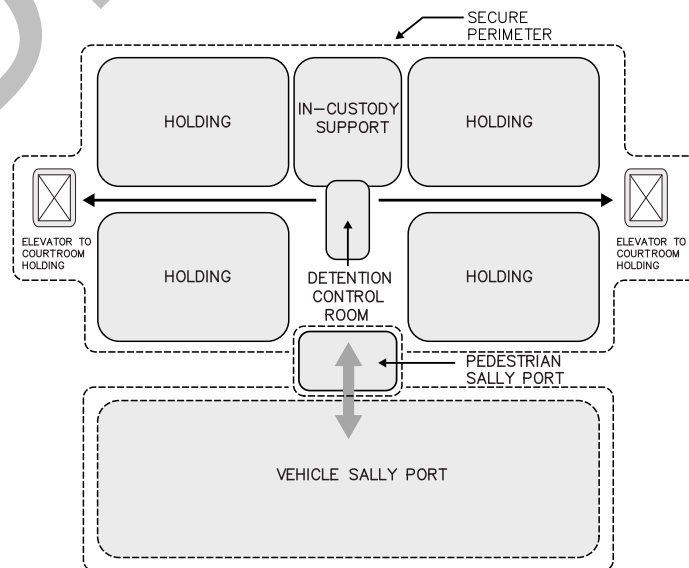

Figure 8.3 Central Holding

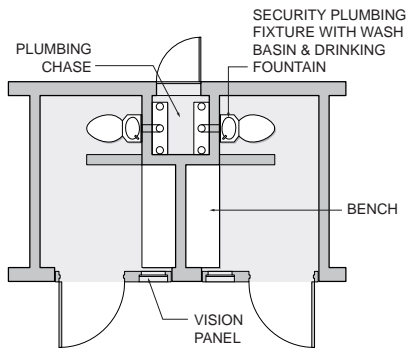

Figure 8.4 Single Holding Cells

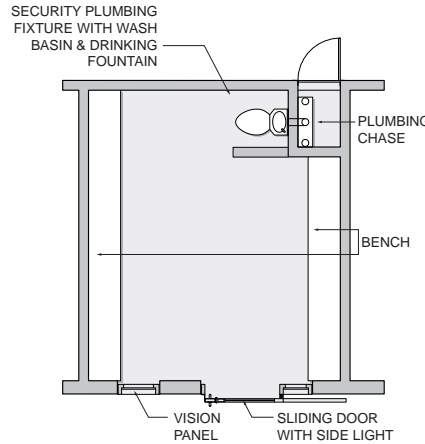

Figure 8.5 Group Holding Cell

- a. Some staging may occur before placement in a holding cell, including a paperwork check and/or pat search. Provide a counter for completing paperwork and benches for in-custody defendants awaiting processing.
- b. Central holding is operational during daytime hours only, with no overnight use of the holding cells. Still, all cells must comply with the requirements of California Code of Regulations, titles 15 and 24, for temporary holding facilities as well as Prison Rape Elimination Act (PREA) standards to maintain privacy of in-custodies. Therefore, they must:
 - Contain a minimum of 10 square feet (SF) of floor area per in-custody;
 - Be limited to no more than 16 in-custodies;
 - Be no smaller than 40 SF;
 - Have a clear ceiling height of 8' or more;
 - Contain seating to accommodate all in-custodies;
 - Contain a toilet, modesty panel, wash basin, and drinking fountain;
 - Contain one-sided privacy film on the glass in the detention door, if required by BSCC; and
 - Be equipped with an audio monitoring system.
- c. Although they are not required by regulation, some cells may be equipped with cameras at the request of the court, subject to Judicial Council review and approval.
- d. Cells must be of secure construction. Fixtures and furnishings should be antiligature (suicide resistant). Accessible holding cells must be available in the central holding area. Provide a minimum of one for each area of separation: male, female, and juvenile. Confirm requirements for mirrors in detention cells, including the accessible cells.
- e. Access to the central holding area is controlled by detention control room staff. Cell doors are controlled remotely by detention control room staff, with manual (key) fail override. If swinging doors are used instead of sliders, they must swing out to prevent the occupant's ability to barricade the door. Cells should be positioned to avoid blind spots and provide optimal sightlines for staff working in the area. Provide glazed cell fronts to maximize visibility.

DIVISION ONE: DESIGN CRITERIA

- 1 General Principles
- 2 Courthouse Organization
- 3 Site Design
- 4 Courthouse Security
- 5 Court Set
- 6 Jury Facilities and Court Administration
- 7 Special Services
- 8 IN-CUSTODY DEFENDANT RECEIVING, HOLDING, AND TRANSPORT**
 - 8.A Objectives
 - 8.B Planning Criteria
 - 8.C Functional Overview
 - 8.D Program Components
 - 8.E Technical Criteria
 - 8.F Electronic Detention Control System
- 9 Public Spaces
- 10 Building Support Services

The door inside the courtroom leading to the courtroom holding shall be designed to match the courtroom decor and is operated by the bailiff.

- f. BSCC requirements state that toilet areas shall allow modesty for in-custodies with staff being able to visually supervise. Toilets should be positioned in cells to allow for surveillance by staff while still providing modesty for the occupants. If supervision is supplemented by video surveillance in the cell area, cameras should be positioned or digitally obscured to allow for privacy of the toilet component.
- g. Sight and sound separation between adults and juveniles in central holding requires separate areas. It is not enough to have separate cells accessed from the same corridor. Note that juvenile probation staff are, generally, responsible for the supervision of in-custody juveniles in central holding; some space for probation staff may be required in this area.

6. Detention Circulation and Elevators

- a. All in-custody holding and circulation must be separated from public and private circulation paths and spaces. The areas associated with in-custody holding and circulation are contained within the secure perimeter. A sally port is required at any penetration allowing access in or out of the secure perimeter and shall be controlled by detention control.
- b. In courthouses with multiple multistory court sets per floor and/or where central holding is not colocated on a court's floor, a dedicated detention circulation path is required to transport in-custody defendants from the central holding area to in-custody elevators serving the courtroom holding areas. Detention corridors shall be 6'-8' wide (refer to chapter 2, Courthouse Organization) and shall minimize turns to facilitate direct line of sight and avoid blind spots created by protrusions. All secure circulation corridors on courtroom floors between courtrooms shall be built to detention-grade standards. The secure corridors in central holding shall have detention-grade floors and walls, but acoustical ceiling tiles or gypsum board ceilings are an acceptable alternative.
- c. The detention control room monitors and controls access and movement of in-custody elevators. In-custody elevators must include video and intercom capabilities and be able to accommodate a gurney. The baseline standard shall be a 4,000-pound-capacity cab with a minimum clear inside dimension of 5'8" × 7'1". Alternative-capacity cabs and cab dimensions may be appropriate for certain courthouses, depending on the size of the courthouse, the number of holding cores, and the Operational Program Statement for the specific courthouse.

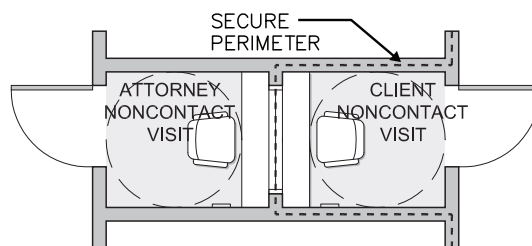

Figure 8.6 Attorney-Client Interview Rooms



Figure 8.7 Attorney-Client Interview Room Window

7. Attorney-Client Interview Rooms

Attorney-client interview rooms provide the opportunity for counsel to consult privately with their in-custody clients. A “noncontact” visitation arrangement is required to prevent the exchange of contraband. Attorneys do not enter the secure perimeter of the in-custody holding areas. In-custody defendants enter the interview room from the secure side (within the secure perimeter), and attorneys enter from the public circulation or a courtroom. (See figure 8.6.)

- a. Both entries shall be separated and enclosed from adjacent spaces to promote confidentiality. The entry on the in-custody side shall have glazing to facilitate visual observation by the courtroom holding officer. The wall between the in-custody defendant and the attorney must meet secure perimeter construction requirements. The two parties view each other via a glazed opening per guidelines outlined in tool 5, In-Custody Interview Room Guidelines. (See figure 8.7.)
- b. Communication shall be facilitated by passive design, without using handsets or amplification devices. Fixed writing surfaces and/or a pass-through window may be provided upon court request.
- c. Attorney interview rooms should be sized for wheelchair movement on both the attorney and in-custody sides. See tool 2, Catalog of Courtroom Layouts, for room sizes. The in-custody side shall have a detention-grade movable plastic chair for the in-custody defendant. Fixed or swivel stools for in-custody defendants are not permitted. In-custody defendants are not expected to open and close doors themselves in holding areas that are manned or have remotely controlled operators. Door handles and locks are not permitted on the interior side of the door.
- d. Spaces should be treated to manage reverberation of sound within, as well as the transmission of sound to adjacent spaces, because conversations held in these rooms are confidential.
- e. Because attorney-client interview rooms are adjacent to courtroom holding areas, in-custody access is from the courtroom holding circulation area, and attorney access is from public circulation or from the courtroom itself, provide a sound-lock vestibule or barriers to both sides for acoustical separation. Determining the location of attorney entrances is based on local court preferences and security staff efficiencies. (See figure 8.8.)
- f. In some instances, typically associated with larger courthouses, local users might request attorney-client interview rooms at the central holding area. This scenario necessitates provisions for public circulation (corridor and/or

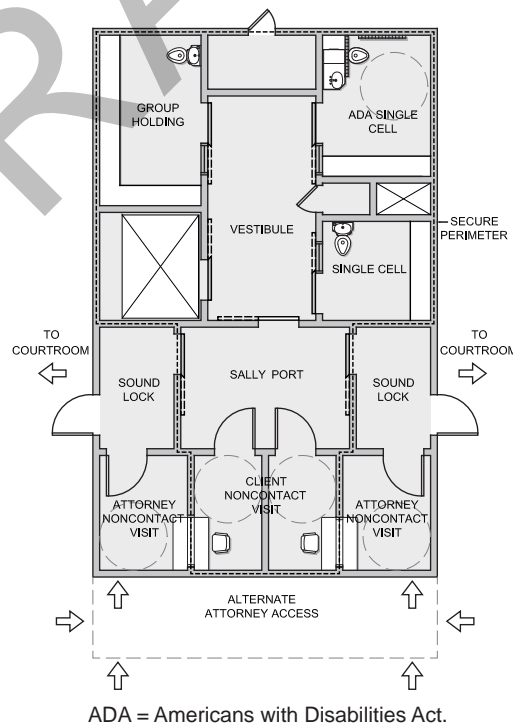

Figure 8.8 Courtroom Holding

DIVISION ONE: DESIGN CRITERIA

- 1 General Principles
- 2 Courthouse Organization
- 3 Site Design
- 4 Courthouse Security
- 5 Court Set
- 6 Jury Facilities and Court Administration
- 7 Special Services
- 8 IN-CUSTODY DEFENDANT RECEIVING, HOLDING, AND TRANSPORT**
 - 8.A Objectives
 - 8.B Planning Criteria
 - 8.C Functional Overview
 - 8.D Program Components
 - 8.E Technical Criteria
 - 8.F Electronic Detention Control System
- 9 Public Spaces
- 10 Building Support Services

Technical Criteria

- Construction/Finishes
- Detention Doors
- Detention Hollow Metal Frames
- Miscellaneous Detention Equipment
- Security Glazing
- Light Fixtures
- Plumbing Fixtures
- Sprinkler Heads
- Mechanical Grilles
- Security Sealants
- Tamper-Proof Metal Fasteners
- Detention Toilet Accessories
- Detention Door Signage

Where possible, cell plumbing fixtures shall not be located adjacent to courtroom partitions. The cell toilet fixture shall have secure plumbing readily serviceable by a technician from outside the cell.

elevators) to extend to central holding, where attorneys would access attorney-client interview rooms from public circulation. The detention control room shall have direct line of sight to attorney-client interview rooms located within the central holding area.

8. Courtroom Holding

- a. Each courtroom shall have direct access to a courtroom holding core that includes a sound-lock vestibule, in-custody holding cells, and an attorney-client interview room. Courtrooms shall be paired, sharing a courtroom holding core.
- b. A sound-lock vestibule acts as a sound buffer between the courtroom and the holding area and screens views from the courtroom into the holding area. In addition, the sound-lock serves as a sally port for managing controlled movement between the two areas. The door inside the courtroom leading to the courtroom holding shall be designed to match the courtroom decor and is operated by the bailiff. Therefore, it does not typically require detention-grade hardware. The inner door leading to the holding area is detention grade and may be operated from the detention control room or manually by the bailiff.
- c. The courtroom holding cells shall:
 - Contain a minimum of 10 SF of floor area per in-custody;
 - Be limited to no more than 16 in-custodies;
 - Be no smaller than 40 SF;
 - Have a clear ceiling height of 8' or more;
 - Contain seating to accommodate all in-custodies;
 - Contain a toilet, modesty panel, wash basin, and drinking fountain;
 - Contain one-sided privacy film on the glass in the detention door, if required by BSCC; and
 - Be equipped with an audio monitoring system.
- d. Cells shall have glazed cell fronts to manage sound from within the cells and to maximize supervision of in-custody defendants by staff. The detention control room may operate cell doors remotely. Cell doors shall be equipped with a manual key override if they are operated from the control room. All cell doors must swing out (or be sliding) to prevent an in-custody defendant from barricading the door. Provide a minimum of one accessible cell per courtroom holding area. All holding cells have penal-grade plumbing fixtures.
- e. In-custody defendants access the noncontact attorney-client interview room from within the courtroom holding circulation area. The design and arrangement of the courtroom holding cells and circulation areas shall facilitate supervision and shall avoid blind spots.
- f. Measures shall be taken to manage sound reverberation within the courtroom holding core as well as prevent the transmission of sound between the courtroom holding core and the adjacent courtroom. Where possible, cell plumbing fixtures shall not be located adjacent to courtroom partitions.

9. Secure In-Custody Holding Support Areas

Several program components are essential to the daily operations of the in-custody holding and transport areas. While essential, they are not accessible to in-custody defendants.

- a. Sheriff Lockers: Confirm locker sizes and types with the sheriff for storage requirements. Confirm locking mechanisms for the sheriff lockers.
- b. Armory: Located within the in-custody secure perimeter, the armory provides for the secure storage of tactical defense equipment. The armory shall be constructed of security-grade partitions that extend to the underside of the structure above. Access is limited to authorized personnel only. The door to the armory shall have hardened door hardware to prevent kick-ins. The armory shall be equipped with monitoring and surveillance devices. Detention control is responsible for monitoring the security of the armory. The need for an armory and its location is dependent on the size of the court facility.
- c. Safety Equipment Storage: A secure area shall be provided for the storage of safety equipment such as fire extinguishers, self-contained breathing apparatus, wire and bar cutters, and emergency lights. The area should lock securely.
- d. Lunch Storage: Provide the ability to store lunches for in-custody defendants who are scheduled to spend a full day at the courthouse. Requirements and protocol for the types of lunches, the quantity of lunches, and how lunches are brought to the court facility are determined on a case-by-case basis. For the storage of in-custody meals, include space and hookups for refrigerated storage, and provide a sink and a general dry storage area. The quantity of storage required depends on the size of the court facility.
- e. Staff Break Room: Locate the staff break room immediately outside the secure perimeter with other security functions. The break room does not require detention-grade finishes or equipment. It should accommodate storage and provide space for vending machines, a coffee machine, a refrigerator, and a table and chairs. The size of and need for a staff break room depends on the size of the court facility.
- f. Janitor Closet: Courtroom holding areas do not require a janitor closet. In the central holding area, at least one securely lockable janitor closet shall be located within the secure perimeter. The janitor closet shall be equipped with a mop sink and sufficient storage for cleaning implements and supplies.
- g. Storage Room: One or more storage rooms shall be provided to accommodate supplies and other materials. Court holding facilities may be excluded from the California Building Code’s storage space requirement for personal and institutional clothing because institutional clothing is issued at a different facility.

8.E TECHNICAL CRITERIA

1. General Information

The purpose of this section is to provide detailed description and technical design direction for the secure construction of the holding areas, including doors, frames, locks, wall construction, surface material finishes, equipment, and fixtures.

- a. Each secure holding area with multiple rooms, whether central or adjacent to the courtroom, requires a secure perimeter of an approved system constructed to the underside of the structure, with a limited number of 8" × 8" or larger penetrations and equipped with security locks and vestibules.
- b. All rooms must have a minimum clear ceiling height of 8' to the underside of surface-mounted light fixtures or other elements. Higher ceilings are preferred when possible, to allow the installation of sprinkler heads and smoke detectors farther from the in-custody defendant.

DIVISION ONE: DESIGN CRITERIA

- 1 General Principles
- 2 Courthouse Organization
- 3 Site Design
- 4 Courthouse Security
- 5 Court Set
- 6 Jury Facilities and Court Administration
- 7 Special Services

8 IN-CUSTODY DEFENDANT RECEIVING, HOLDING, AND TRANSPORT

- 8.A Objectives
- 8.B Planning Criteria
- 8.C Functional Overview
- 8.D Program Components
- 8.E Technical Criteria
- 8.F Electronic Detention Control System

- 9 Public Spaces
- 10 Building Support Services

2. Construction and Finishes

2.1 Floor Construction

The floor construction at all areas within the security perimeter of the central and courtroom holding areas will be concrete. Also, to help prevent flooding of the holding areas, slope the floor to the floor drains.

2.2 Concrete Floor Finishes

- a. A sealed concrete floor finish shall consist of a chemical hardener/sealer finish. This finish is used at non-in-custody traffic areas and areas that typically see a low volume of foot traffic. These areas include but are not limited to janitor closets, mechanical rooms, and storage rooms.
- b. A polished concrete floor finish shall consist of a combination of diamond grinding and polishing using a chemical hardener and sealing agent to get the desired level of concrete finish. This finish is used in in-custody circulation areas where a high volume of in-custody traffic is expected. These areas include but are not limited to corridors, sally ports, and staging areas.
- c. An epoxy resinous floor system shall consist of an elastomeric primer, two intermediate coats of clear mixed liquids with aggregate, and a final clear glazing coat. This finish is used at all in-custody cells and in-custody–attorney visiting areas. This finish can also be used at corridors, sally ports, and staging areas.

2.3 Wall Construction

- a. Wall construction of 8" concrete masonry units grouted solid with 3,000 pounds per square inch (psi) grout, including vertical and horizontal reinforcing to the underside of the structure, shall be used at all central, courtroom holding, and detention control room secure perimeter walls.
- b. A wall system with 8" or 6" concrete masonry units grouted solid with 3,000 psi grout and vertical reinforcing to a height of 10' above the finished floor and extended to the underside of the structure with 3-5/8" 20-gauge metal studs at 16" on center with secure metal lath and 5/8" high-impact Type X gypsum board on both sides of the metal studs shall be used inside the security perimeter at walls that are required to extend to the underside of the structure, such as rated corridor walls.
- c. A wall system with 8" or 6" concrete masonry units grouted solid with vertical reinforcing to a height determined by the designers and generally extended a minimum of 8" above the finished ceiling shall be used inside the security perimeter at walls that are not required to extend to the underside of the structure, such as nonrated corridor walls. If these walls are part of the secure envelope, they must be tied into the secure ceiling.
- d. Precast concrete wall panels with thicknesses based on the level of security can be used for walls both forming and inside the security perimeter.
- e. A metal wall panel detention system has a typical panel thickness of 2" with 10-gauge faceplates on each side and 10-gauge base, wall, and ceiling channels. Panels are also grouted solid with 3,000 psi grout. This wall system can be used at cell fronts, cell backs, and cell demising walls. Limitations would be height of panels and fire ratings over one hour.
- f. Do not use detention panels for rated walls. Only use concrete masonry unit (CMU) for detention-rated walls. Develop or specify grouting installation

procedures for CMU detention-rated walls. Do not locate equipment that requires access above detention cells.

2.4 Wall Finishes

- a. A fiber-reinforced epoxy abrasion-resistant coating system consists of a surface preparation followed by a primer coat, body coat, and final coat. This finish system shall be used in all holding cells and in-custody–attorney interview rooms. This finish can also be used in circulation areas.
- b. Epoxy paint system is a low-VOC (volatile organic compound) product consisting of a block filler and two topcoats. This finish shall be used as an 8" high base at all latex enamel-painted walls and can be used at all circulation walls.
- c. A latex enamel paint system is a low-VOC product consisting of a block filler and two topcoats. This finish shall be used at all circulation areas and all non-in-custody–accessible areas.
- d. A stainless steel finish shall be used on all in-custody elevator cab walls.

2.5 Ceiling Construction

- a. A system of precast concrete with all ceiling joints grouted solid is painted in the field and can be used at all areas except where acoustic ceilings are required.
- b. Acoustic steel roof/floor deck consists of a cellular deck profile with a ribbed deck welded to an acoustic perforated bottom plate. The deck thickness is typically 1-1/2" or 3" with a lightweight concrete topping slab. Factory-installed sound-absorbing insulation is installed into the cells of the deck. This system comes with a primer and requires final painting in the field. This system shall be used at all holding cell and in-custody–attorney visiting areas.
- c. An acoustic panel deck consisting of a one-piece galvanized steel plate with 5/32" diameter perforated holes is typically 14 gauge with a heavy-duty steel frame. Antimicrobial and sound-deadening insulation is installed on top of the panels. The system comes with a durable powder coat finish and shall be used at all circulation areas.
- d. An acoustic metal ceiling panel detention system is the ceiling system for the metal wall panel detention system. The typical panel thickness is 2" with a perforated acoustic bottom plate and sound-absorbing insulation installed in the panels. This system comes with a primer and is painted in the field with two topcoats of a low-VOC latex enamel paint.
- e. An acoustical ceiling tile of either 2' × 2' or 2' × 4' on a suspension grid with hanger wires comes with a factory finish and can be used in non-in-custody–accessible areas. This system can also be used in in-custody circulation areas where the ceiling height is greater than 10' and hold-down clips are provided.
- f. A system of 5/8" high-impact gypsum board on a suspension grid with hanger wires is painted in the field and shall be used in non-in-custody–accessible areas such as staff toilets and janitor closets.
- g. Stainless steel is a factory finish and shall be used in in-custody elevators.
- h. Exposed construction would have no finish and could be used in a mechanical or electrical-type room.

DIVISION ONE: DESIGN CRITERIA

- 1 General Principles
- 2 Courthouse Organization
- 3 Site Design
- 4 Courthouse Security
- 5 Court Set
- 6 Jury Facilities and Court Administration
- 7 Special Services

8 IN-CUSTODY DEFENDANT RECEIVING, HOLDING, AND TRANSPORT

- 8.A Objectives
- 8.B Planning Criteria
- 8.C Functional Overview
- 8.D Program Components
- 8.E Technical Criteria
- 8.F Electronic Detention Control System

- 9 Public Spaces
- 10 Building Support Services

Table 8.1 Technical Matrix

	Single Holding Cell	Group Holding cell	Holding Control Room	In-custody Circulation	In-custody Sally Port	Pedestrian Sally Port	Vehicle Sally Port	Sally Port Staging	In-custody Interview	Attorney Interview Room	In-custody Search	Armory
Swing and Sliding Door Types												
Detention Hollow Metal Flush Door						•						•
Detention Hollow Metal Flush Door with Cuff Pass												
Detention Hollow Metal Half Glass Door			•					•	•	•		
Detention Hollow Metal Half Glass Door with Cuff Pass	•	•										
Detention Hollow Metal Vision Panel Door				•	•		•					
Detention Hollow Metal Vision Panel Door with View Shutter											•	
Hollow Door Frame Types												
Controlled Swing/Slider Door			•	•								
Controlled Swing/Slider Door with Sidelight	•	•			•	•	•	•				
Noncontrolled Door											•	•
Noncontrolled Door with Sidelight									•	•		
Borrowed Light Frame									•	•		
Control Room Borrowed Light Frame			•									
Security Glazing Types												
Glass-clad polycarbonate glazing manufactured (requirements at 8.E.6.2, Security Glazing Types)					•				•	•	•	
Laminated polycarbonate glazing manufactured (requirements at 8.E.6.2, Security Glazing Types)	•	•		•			•	•				•
Glass-clad polycarbonate with tinting film for one-way vision			•									
Benches												
Detention Benches (requirements at 8.E.4.2, Detention Benches)	•	•			•			•			•	
Detention Equipment												
Paper pass (requirements at 8.E.5.1, Detention Equipment Types)			•									
Gun locker (requirements at 8.E.5.1, Detention Equipment Types)												•
Pistol Lockers					•	•	•	•				

3. Detention Doors

3.1 Detention Swing Doors

See table 8.1 for locations and type.

- a. Fabricate detention hollow metal doors from 12-gauge galvanized steel face sheets spot-welded to the internal core construction.
- b. The top and bottom edges of the door shall be closed with a continuous closing channel. The vertical edges of the door shall be reinforced by a continuous steel channel, not less than 12 gauge, extending the full length of the door. Edge seams shall be continuously welded and finished till smooth such that no seams are visible. All metal doors shall have a flush top and bottom edge channel and shall be welded to the closing channel.
- c. Provide cuff passes at the edge of all cell doors and at the door on the in-custody side of attorney-client interview rooms.
- d. The door finish shall match the wall finish on that side of the door.
- e. All cell doors must swing out of all cells and attorney visiting rooms.

3.2 Detention Sliding Doors

See table 8.1 for locations and type.

- a. Provide sliding detention door device assemblies, including locking device, receiver, overhead door hanger, bottom door guide, lock column, and enclosure as a complete assembly.
- b. Provide cuff passes at the edge of all cell doors.
- c. The door finish shall match the wall finish on that side of the door.
- d. Detention swing and sliding door types include:
 - Detention hollow metal flush door with or without cuff pass;
 - Detention hollow metal half-glass door with or without cuff pass; and
 - Detention hollow metal vision-panel door with or without view shutter.

3.3 Cuff Passes in Detention Doors

- a. Standard cuff pass opening shall be 16" long × 5" high with 10 Series lock and continuous hinge. Cuff pass shall be flush with the door.
- b. Horizontal center line of cuff port shall be 35" from finished floor. See figure 8.9 for center line height requirement for cuff pass.
- c. Cuff pass shall be installed at the factory in the detention door and integral door frame.
- d. The detention door shall have an integral glazed opening for visual surveillance. The glazing shall be single pane, with the lower half including a tinted film for modesty screening. See table 8.1 for glazing requirements. See figure 8.9 for glazed opening in the detention door.
- e. Standardize door type, configuration, glazing, and cuff pass design and placement to reduce costs associated with unique door designs for new courthouses and replacement doors. Off-the-shelf detention doors that meet these requirements are recommended.

DIVISION ONE: DESIGN CRITERIA

- 1 General Principles
- 2 Courthouse Organization
- 3 Site Design
- 4 Courthouse Security
- 5 Court Set
- 6 Jury Facilities and Court Administration
- 7 Special Services

8 IN-CUSTODY DEFENDANT RECEIVING, HOLDING, AND TRANSPORT

- 8.A Objectives
- 8.B Planning Criteria
- 8.C Functional Overview
- 8.D Program Components
- 8.E Technical Criteria
- 8.F Electronic Detention Control System

- 9 Public Spaces
- 10 Building Support Services

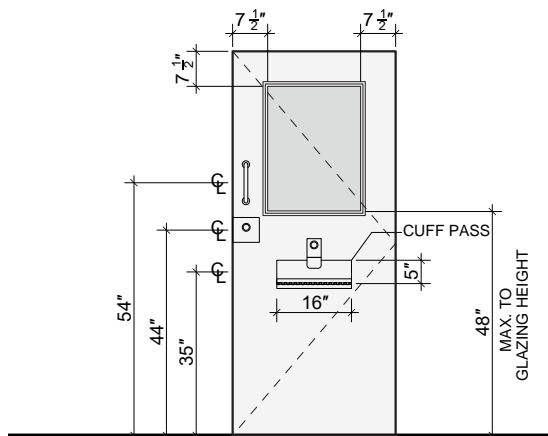

Figure 8.9 Glazed Opening and Center Line Height of Cuff Pass in Detention Door

- f. Obtain approval of the county sheriff and Judicial Council before making final selection of detention door with cuff pass during the design phase of the project.
- g. Shop drawings of door and frame assembly with the cuff pass shall be submitted for Judicial Council approval.

3.4 Detention Electric Locks

- a. For swinging cell doors, electrical operation, maximum security:
 - Lock is frame-mounted 115 volts of alternating current (VAC), continuous-duty solenoid operated;
 - Bolt is retracted electrically by icon at the control panel and remains retracted until door is opened;
 - Bolt is retracted manually by mogul key on outside and/or inside;
 - Internal switches monitor status of bolt to show deadlocked and unlocked conditions;
 - Galvanized case at exterior installations shall be provided; and
 - A key cylinder extension for locks keyed both sides or keyed stop side shall be provided.
- b. For circulation swing doors, motor operation, maximum security:
 - Lock is frame-mounted 115VAC, motor operated;
 - Bolt is retracted electrically by icon at the control panel and remains retracted until door is opened;
 - Bolt is retracted manually by mogul key on outside and/or inside;
 - Internal switches monitor status of bolt to show deadlocked and unlocked conditions; and
 - A key cylinder extension for locks keyed both sides or keyed stop side shall be provided.

3.5 Detention Mechanical Locks

- a. For detention access panels and cuff passes—mechanical operation:
 - Lock is a door-mounted deadbolt;

- Bolt is retracted manually by paracentric (lever tumbler; mogul-pin tumbler) key on outside only;
 - Door strike shall be provided; and
 - Hollow metal lock mounting, escutcheon, and security screws shall be provided.
- b. For swinging doors—mechanical operation:
- Lock is a door-mounted, paracentric key deadlocking latch bolt with three hardened steel pins;
 - Bolt is retracted manually by paracentric key on outside and/or inside;
 - Hollow metal lock mounting, escutcheon, and security screws shall be supplied;
 - Door strike shall be provided; and
 - Galvanized case and cylinder shields at exterior installations shall be provided.

3.6 Electromechanical-Locking, Electromechanical-Door-Movement, Sliding Door Device Assemblies

- a. These assemblies are operated from a remote-control panel that activates electric motors to unlock sliding doors and motorized rack-and-pinion drive mechanisms to open and close doors. Doors lock in open position and deadlock when closed. Provide factory-wired cable harness with plug connectors for each motor unit.
- b. Each door can be individually unlocked locally or from a remote panel—or unlocked from a remote panel with other doors as a group. In an emergency or if power fails, each door can be manually operated from a pilaster release adjacent to receiving jamb of each door operated by paracentric key; doors shall not relock in any position.
- c. The electric key switch is operated by paracentric key and shall provide electric control of detention sliding door operation at door location, where indicated.

3.7 Detention Door Hardware

The hardware listed below is the minimum requirement for detention doors; additional hardware may be required. Coordinate hardware selection with the sheriff’s office.

- a. Detention hinges shall be cast stainless steel leaves with integral security studs, nonremovable stainless steel pins, stainless steel ball bearings, three knuckle with hospital tips.
- b. Concealed door closers shall have full hydraulic, rack-and-pinion action with high-strength cast iron cylinder.
- c. Concealed door position switches shall be a mortise installation overhead mounting with switch contacts housed in the door frame and actuating magnet mortised into the top of the door.
- d. Keeper switches shall be a mortise installation with limit-monitoring switch housed in the door frame. All manual locks shall use keeper switches.

**DIVISION ONE:
DESIGN CRITERIA**

- 1 General Principles
- 2 Courthouse Organization
- 3 Site Design
- 4 Courthouse Security
- 5 Court Set
- 6 Jury Facilities and Court Administration
- 7 Special Services
- 8 IN-CUSTODY DEFENDANT RECEIVING, HOLDING, AND TRANSPORT**
- 8.A Objectives
- 8.B Planning Criteria
- 8.C Functional Overview
- 8.D Program Components
- 8.E Technical Criteria**
- 8.F Electronic Detention Control System
- 9 Public Spaces
- 10 Building Support Services

Where possible, cell plumbing fixtures shall not be located adjacent to courtroom partitions. The cell toilet fixture shall have secure plumbing readily serviceable by a technician from outside the cell.

- e. Push plates shall be 3/16" thick stainless steel 32" wide × 16" high with 7/8" lip projection at bottom. Attach with stainless steel security rivets.
- f. Pull-loops shall be cast bronze satin chrome plated with a dimension of 8-3/4" long × 12" clearance.
- g. Pull-flush shall be cast bronze satin chrome plated with a dimension of 4" wide × 5" high × 1" deep.
- h. Doorstops shall be black silicone rubber 2" diameter, mounted on a 5/8" × 2-1/2" steel shank for permanent attachment in grout-filled masonry or concrete.
- i. Door cuff passes shall be 16" long × 5" high with 10 Series lock and continuous hinge. Cuff passes shall be flush with the door face.
- j. For cylinders, keys, and keying, the detention locks shall incorporate two separate keying systems: one for lever tumbler (paracentric) and one for pin tumbler (mogul cylinder) locks. Each keying system's keys shall be die stamped for identification. For all individual key designations, three keys each shall be provided. For each master key designation, four keys each shall be provided.

4. Detention Hollow Metal Frames

- a. Fabricate frames from 12-gauge steel, with mitered corners continuously welded through head inside corner and miter ground smooth.
- b. The manufacturer shall provide all frames with approved jamb anchors, floor knees, plaster boxes, removable angle spreaders, and door silencers.
- c. All frames are to be grouted solid with frame anchors tied to rebar. All glazing stops and fasteners are to be installed on the non in-custody side of the frame. The frame finish is to match the wall finish on that side of the frame.

4.1 Detention Hollow Metal Frame Types

Detention hollow metal frame types include:

- Controlled swing/slider door with or without sidelight;
- Noncontrolled door with or without sidelight;
- Borrowed light frame; and
- Control room borrowed light frame.

4.2 Detention Benches

- a. Detention benches shall be provided at all holding cells and other areas where detention seating may be required. All benches must meet ADA requirements for height and depth.
- b. The metal bench can be part of the metal wall panel detention system and should be constructed to meet the wall panel requirements. The bench should come primed and need its final painting to be done in the field.
- c. The concrete top with masonry base shall be constructed out of a minimum 4" thick concrete and minimum 6" concrete masonry unit base grouted solid and reinforced. The concrete top shall be finished with sealer/hardener, and the finish of the masonry base shall match the wall finish surface.

5. Miscellaneous Detention Equipment

5.1 Detention Equipment Types

- a. Paper pass shall be provided with a built-in bottom made from stainless steel. The size will be 16" long × 10" wide × 2" high × 1-1/2" deep. It shall have a factory finish.
- b. Pistol lockers shall be made up of six compartment lockers with 3/16" shell and doors. Compartments shall be lined with 1/8" felt with swing-out compartment doors on continuous hinges. Provide each compartment with snap locks, each compartment individually keyed and master keyed. The unit comes primed and will require final painting in the field.
- c. A gun locker with a 3/16" shell and doors shall be provided in the armory and shall be capable of holding a minimum of six rifle-type weapons. The compartment shall have a felt lining and a secure door that is keyed. The unit comes primed or with a factory finish. Confirm gun locker location, size, and quantity, and provide details for backing and surrounding finish trim, if recessed.

5.2 Detention Access Panels

- a. Fire-rated detention access panels are to be rated for 90 minutes. The frame shall be constructed out of 16-gauge cold-rolled steel with 1" wide surface-mounted trim. The door shall be constructed out of 14-gauge cold-rolled steel with 2" of fire-retardant insulation enclosed in sheet metal. Provide a continuous piano hinge and an automatic self-latching door closure. The panels come primed and will require a final field painting.
- b. Nonrated detention access panels are to have a 3" × 2" × 3/16" steel angle frame with 1" × 1" × 1/8" angle stops on three sides. Door construction is to be 3/16" steel with 1-1/4" flange on all four sides. Equip each panel with two hinges. The panels come primed and will require a final field painting.
- c. Provide safety chain on swing-down ceiling-type detention access panels.
- d. Do not locate detention access panels in holding cells or other areas where in-custodies may be left alone.

6. Security Glazing

6.1 Security Glazing Locations

Locations for security glazing shall include:

- Detention doors;
- Detention glazed frame;
- Control room;
- Attorney-client interview; and
- Court dock area.

6.2 Security Glazing Types

- a. See table 8.1 for locations and type. In the holding cells, an effort shall be made to provide laminated polycarbonate glazing. Based on supply chain availability, glass-clad polycarbonate glazing may be approved by the Judicial Council.
- b. Glass-clad polycarbonate glazing shall be manufactured to comply with the following requirements (see table 8.1 for locations and type):

DIVISION ONE: DESIGN CRITERIA

- 1 General Principles
- 2 Courthouse Organization
- 3 Site Design
- 4 Courthouse Security
- 5 Court Set
- 6 Jury Facilities and Court Administration
- 7 Special Services

8 IN-CUSTODY DEFENDANT RECEIVING, HOLDING, AND TRANSPORT

- 8.A Objectives
- 8.B Planning Criteria
- 8.C Functional Overview
- 8.D Program Components
- 8.E Technical Criteria
- 8.F Electronic Detention Control System

- 9 Public Spaces
- 10 Building Support Services

- Consisting of a layer of strengthened glass, a polycarbonate core, and a layer of strengthened glass.
 - Bullet resistance: H. P. White TP 500 Level A, Weapon .38 Special (three shots).
 - Forced-entry resistance: H. P. White TP 500 Level II and ASTM F1915 Grade 2.
 - Tinting film at control rooms.
- c. Laminated polycarbonate glazing shall be manufactured to comply with the following requirements:
- Consisting of a layer of polycarbonate mar-resistant outer layer, a polycarbonate core, and a layer of polycarbonate mar-resistant outer layer.
 - Bullet resistance: H. P. White TP 500 Level A, Weapon .38 Special (three shots).
 - Forced-entry resistance: H. P. White TP 500 Level I and ASTM F1915 Grade 2.

7. Security Light Fixture Types

- a. Maximum-security light fixtures can be either recessed or surface mounted with a 12-gauge one-piece seamless doorless unit and a prismatic polycarbonate lens. Recessed fixtures must maintain the continuity of the security ceiling and not be removable. The light fixture comes with a factory finish. These light fixtures shall be located at all cells, all attorney interview rooms, and the court dock area.
- b. Medium-security light fixtures can be either recessed or surface mounted with a 14-gauge one-piece seamless doorless unit and a prismatic lens. Recessed fixtures must maintain the continuity of the security ceiling and not be removable. The light fixture comes with a factory finish. These light fixtures shall be located at all in-custody circulation areas and other areas where in-custodies have access.
- c. Architectural-grade fixtures can be recessed or surface mounted and come with a factory finish. These light fixtures can be used in areas where in-custodies have no access, such as administration areas.

8. Security Plumbing Fixture Types

- a. A standard rear-wall-mounted chase-accessible unit shall be installed at all in-custody areas where an accessible unit is not required. The unit shall be constructed out of a 14-gauge, type 304 stainless steel cabinet and toilet bowl. Include a toilet paper holder and a penal hemispherical bubbler. The unit comes with a factory finish. The unit shall also be provided with an electronic water usage controller, to allow for the unit's solenoid to be controlled to prevent vandalism or excessive flushing. The electronic water usage controller shall be inaccessible to the in-custody defendants and managed by the facility management staff. The cell toilet fixture shall have a secure plumbing chase inaccessible to in-custody defendants but readily serviceable by a technician from outside the cell.
- b. An accessible rear-wall-mounted chase-accessible unit shall be installed at all in-custody areas where an accessible unit is required. The unit shall be constructed out of a 14-gauge, type 304 stainless steel cabinet and toilet bowl. Include a toilet paper holder, an antiflood device, a penal hemispherical bubbler, and a grab bar assembly. The unit comes with a factory finish. The cell toilet fixture shall have a secure plumbing chase

inaccessible to in-custody defendants but readily serviceable by a technician from outside the cell.

- c. In medium or large court buildings, provide a sewage grinder system to all waste lines that connect to detention toilet fixtures. This system is typically located outside the building perimeter.
- d. Architectural-grade plumbing fixtures such as toilets and lavatories can be used in all areas where in-custodies have no access, such as administration areas. These fixtures come with a factory finish.
- e. Provide floor drains in all holding areas per the plumbing code, with detention drain covers and fasteners. Detention-grade floor drains shall be provided outside the door of each in-custody holding cell.

9. Security Sprinkler Head Types

- a. Provide detention-grade, ceiling-mounted sprinkler heads in all in-custody-accessible areas. Sprinkler heads must meet Compliance Services and Assessments, LLC (CSA) standards for suicide prevention and be located a minimum of 8' above the finish floor. The sprinkler heads come with a factory finish. Tyco Raven institutional sprinkler heads shall be the basis of design and pricing, with smooth underside and no protruding elements.
- b. Provide non-detention-type sprinkler heads in all areas where in-custodies have no access, such as administration areas.

10. Security Mechanical Grille Types

- a. Use wall- and ceiling-mounted grilles in all in-custody-accessible areas. Provide a risk-resistant grille with a nonvision core consisting of a 3/16" faceplate with louvers, vertical mullions, sleeve, and four-sided mounting frame. The grilles come with a factory finish.
- b. Provide non-detention-type grilles in all areas where in-custodies have no access, such as administration areas.
- c. Provide detention duct bars at all openings larger than 5" x 5". Duct bars are to be tool-resistant 7/8" diameter steel bars spaced so that no opening is bigger than 5" in diameter.
- d. Provide security bars at all openings and/or penetrations of secure perimeter envelope larger than 5" x 5". Security bars are to be tool-resistant 7/8" diameter steel bars spaced so that no opening is bigger than 5" in diameter.

11. Security Sealant Types

For more information on sealants, see table 8.2.

- a. Security joint sealant shall be a two-component, premium-grade, polyurethane-based elastomeric sealant.
- b. Security epoxy resin gap filler (low-mod gel) shall be a two-component, 100 percent solids, moisture-tolerant, low-modulus, nonsag, paste-consistency epoxy resin binder.

12. Tamper-Proof Metal Fasteners

- a. Use Torx-head (star design with center pin) security fasteners. Finish shall match that specified of the item anchored.

DIVISION ONE: DESIGN CRITERIA

- 1 General Principles
- 2 Courthouse Organization
- 3 Site Design
- 4 Courthouse Security
- 5 Court Set
- 6 Jury Facilities and Court Administration
- 7 Special Services

8 IN-CUSTODY DEFENDANT RECEIVING, HOLDING, AND TRANSPORT

- 8.A Objectives
- 8.B Planning Criteria
- 8.C Functional Overview
- 8.D Program Components
- 8.E Technical Criteria
- 8.F Electronic Detention Control System

- 9 Public Spaces
- 10 Building Support Services

Table 8.2 Sealant Matrix

LOCATIONS	ALL CELLS, INTERVIEW & CONTROL ROOMS	CORRIDORS & COURT DOCK AREAS	ADMIN, STAFF & COURTROOM AREAS
Detention Hollow Metal Frames	SGF	SGF	SGF
Arch. Door & Window Frames	SJS	SJS	LJS
Mech. Grilles/Diffusers	SGF	SJS	LJS
Water Closets & Lavatories	SGF	N/A	LJS
Sprinkler Heads/Plumbing	SGF	SGF	N/A
Security Light Fixtures	SGF	SJS	N/A
Exposed Conduit/Raceways	SGF	SJS	N/A
Switch/Outlet	SGF	SJS	N/A
In-custody Duress Plates	SGF	SJS	LJS
Misc. Detention Equip. (Mirrors)	SGF	N/A	N/A
Interior Wall Systems at Base	SGF	SGF	SGF
Wall & Ceiling Joint	SGF	SJS	N/A
Intercom Call Stations	SGF	SJS	LJS

LJS = latex joint sealants. These are typical architectural sealants.

SJS = security joint sealant.

SGF = security epoxy resin gap filler.

N/A = not applicable.

- b. Fabricate removable tamper-proof fasteners to allow removal only by tools produced by the fastener manufacturer or another licensed fabricator specifically for individual tamper-proof fastener design. Limit size and shape variations such that no more than six tools are required for each type of tamper-proof fastener used on a project.
- c. Provide tamper-proof metal fasteners at all central and court holding areas where in-custodies have access.

13. Detention Toilet Accessories

- a. Use grab bars with underslung plate to prevent suicides.
- b. Provide a recessed toilet paper holder if it is not part of the toilet fixture.
- c. Use a detention mirror with embedded mounting plate.
 - Mirror frame dimension shall be 12-1/2" × 16-1/2", fabricated from 16-gauge mild steel. The 5/16" × 1" mirror frame is to be chrome plated. Mirror opening shall be 10-1/2" × 14-1/2", and mirror shall be made of 20-gauge stainless steel polished for high reflectivity.
 - Embedded mounting plate is to be constructed of 1/4" plate steel with two 11-gauge × 3" wide bent steel anchors with minimum 1" bend. Embedded plate shall be drilled and tapped for security fasteners.
 - For accessible mirrors, use either two mirrors or one longer mirror for both applications.

14. Detention Door Signage

- a. Provide low- or no-VOC paint, exterior alkyd gloss enamel on interior and exterior ferrous surfaces.
- b. Provide 6" high numbers on the face of all controlled and monitored doors within the central and court-secure perimeters.

- c. Provide 6" high numbers on both sides of the face of all doors that are in circulation areas within the central and court-secure perimeters.

8.F ELECTRONIC DETENTION CONTROL SYSTEM

1. Overview

The electronic detention control system (DCS) consists of integrated electronic subsystems that provide holding area monitoring and control from a detention control room (DCR) and from alternative locations where designated in larger facilities, such as a security operations center (SOC). The DCS's electronic subsystems include programmable logic controls, video surveillance, intercom, and a distributed antenna system. The systems are designed to enhance manual processes and staff safety while maintaining a secure and protective environment for in-custody defendants awaiting trial. See table 8.3.

Table 8.3 Electronic Detention Control Requirements

	Locking—Local	Locking—Remote	Door Interlock	Cameras	Video Recording	Audio Monitoring	Audio Communication	Call Button	Monitoring and Control	Card Access	Card and PIN Access	Gate Control	Duress Buttons
Secure Driveway				R	R		R			R		R	
Sally Port—Vehicle	R		R	R	R	R	R	R					R1
Sally Port—Man Door	R		R	R	R	R	R	R		R1			
Holding Cell—Group	R		D	P	R	R	R		R				
Holding Cell—Individual	R		D	P	R	R	R		R				
Courtroom Holding Vestibules	R		R	R	R	R	R		R				R1
Courtroom Holding Cells	R		R	R	R	R	R		R				
Interview Rooms	R		D	D	R1			R	C				
Elevator	R		R	R	R	R	R		R				
Stairwell	R		R1	R	R	R	R		R				
Corridor	R		R1	R	R	R	R		R				R1
Armory	R			R	R						R		
Holding Control	R		R1						R	R			R1
Auxiliary Control				M	M								
Remote Holding Control		R1							R	R			

R = required.

R1 = required as applicable.

P = partial requirement.

D = discretionary.

M = monitoring only.

C = control.

DIVISION ONE: DESIGN CRITERIA

- General Principles
- Courthouse Organization
- Site Design
- Courthouse Security
- Court Set
- Jury Facilities and Court Administration
- Special Services
- IN-CUSTODY DEFENDANT RECEIVING, HOLDING, AND TRANSPORT**
 - Objectives
 - Planning Criteria
 - Functional Overview
 - Program Components
 - Technical Criteria
 - Electronic Detention Control System
- Public Spaces
- Building Support Services

2. Transport Driveway

- a. Transport vehicles delivering in-custody defendants access the vehicle sally port through a secure driveway. Provide sliding or swinging gates and barrier arm gates to control secure driveway access and egress. Provide for remote control of gates from the DCR or from a card reader located at the secure driveway.
- b. Provide sensors and programming used during vehicle gate entry and exit sequences to detect vehicles and prevent them from being stranded or trapped between vehicle control points. Sensors employed include in-ground vehicle detector loops, photoelectric beams, and leading-edge gate and barrier arm sensors.

3. Transport Driveway Entry

When a transport vehicle approaches the secure driveway, the driver communicates with the DCR either from the vehicle or from a pedestal-mounted intercom to request access. Alternatively, the driver may use a card reader for automated entry. A vehicle detection loop shall be provided to detect vehicles, enable the gate card reader, and call up adjacent surveillance cameras. Entrance gate card readers are otherwise deactivated. Vehicle pedestals shall be provided with single- and dual-height pedestal heads to accommodate a variety of vehicles, and vehicle types must be coordinated at each site to ensure that appropriate security pedestals are provided.

The DCR monitors secure driveway surveillance cameras and gate status and controls vehicle gates from a DCS touchscreen computer. When the DCR grants secure driveway access, the entrance gate and barrier arm open and the transport vehicle enters. The barrier arm and entrance gate close immediately after the transport vehicle has cleared its respective safety sensors and entered the secure driveway.

4. Transport Driveway Exit

When a transport vehicle approaches the secure driveway exit gate, it shall pass over a vehicle detector loop, which opens the gate. The barrier arm and vehicle gate shall close after the transport vehicle has cleared its respective safety sensors and exited the driveway. The DCR can remotely control the exit gate and barrier arm via the DCS.

5. Vehicle Sally Port

Vehicle sally port entry and exit sequences shall employ sensors and programming to detect vehicles and prevent them from being stranded or trapped between vehicle control points. Sensors employed shall include in-ground vehicle detector loops, photoelectric beams, and leading-edge door sensors.

6. Vehicle Sally Port Entry

- a. The transport driver communicates with the DCR to request entry on approach to the vehicle sally port. An in-ground vehicle detection loop shall be located at the sally port entrance to detect vehicles and call up and display an entry surveillance camera in the DCR. The DCR operator may manually call up vehicle sally port cameras via the DCS.
- b. The DCR monitors sally port surveillance cameras and doors and controls sally port doors from a touchscreen computer. When sally port access is requested, the DCR confirms whether sally port doors are secure. If sally port doors are secure, the sally port may be opened to allow transport vehicle access. If any sally port door is not secure, no other sally port door can be opened. The entry door may be closed after the transport vehicle has cleared the door safety sensors and entered the sally port. If a safety sensor is activated while the door is closing, the door shall stop and reverse to the

open position, and the DCS shall generate an alarm. The door may be closed after safety sensors are cleared.

- c. *Open, stop, and close* manual override door controls shall be provided in a locked and monitored enclosure at the sally port door. The *open* function opens the door, the *stop* function stops the door in its current position, and the *close* function closes the door.

7. Vehicle Sally Port Exit

The transport vehicle driver communicates with the DCR to request exit from the vehicle sally port.

- a. The DCR monitors sally port surveillance cameras and doors and controls sally port doors from a touchscreen computer. When sally port exit is requested, the DCR confirms whether sally port doors are shown as secure on the DCS touchscreen computer. If sally port doors are secure, the sally port may be opened to allow transport vehicle exit. If any sally port door is not secure, no other sally port door can be opened. The exit door may be closed after the transport vehicle has cleared the door safety sensors and exited the sally port. If a safety sensor is activated while the door is closing, the door shall stop and reverse to the open position, and the DCS shall generate an alarm. The door may be closed after safety sensors are cleared.
- b. *Open, stop, and close* manual override door controls shall be provided in a locked and monitored enclosure at the sally port door. The *open* function opens the door, the *stop* function stops the door in its current position, and the *close* function closes the door.

8. Pedestrian Sally Port

When sally port access is requested, the DCR operator confirms whether sally port doors are secure. If sally port doors are secure, the sally port may be opened to allow officer access. If any sally port door is not secure, no other sally port door can be opened. After the officer accesses the sally port, manual doors are closed by the officer, and motorized doors are closed via the DCS.

9. Central Holding Door Operation

Central holding door types include corridor doors and holding cell doors, either swinging or sliding, as defined in 8.E, Technical Criteria.

9.1 Door Operation Process

- a. When an officer communicates with the DCR by intercom requesting central holding door access, a graphic of the door shall be automatically displayed on the DCS touchscreen display, and the door surveillance camera shall be automatically displayed on a video monitor.
- b. When an officer communicates with the DCR by other means, the DCR operator selects the appropriate graphic map icon from the DCS touchscreen, which shall display a graphic map of the door location on the touchscreen and the relevant surveillance camera feed on a video monitor.
- c. The DCR monitors central holding surveillance cameras and doors and controls central holding doors from a DCS touchscreen computer. When central holding door access is requested, the door shall be able to be opened from the DCR to allow officer access to the corridor or holding cell. After the officer accesses the central holding door, manual doors are closed by the officer, and motorized doors are closed via the DCS.

DIVISION ONE: DESIGN CRITERIA

- 1 General Principles
- 2 Courthouse Organization
- 3 Site Design
- 4 Courthouse Security
- 5 Court Set
- 6 Jury Facilities and Court Administration
- 7 Special Services

8 IN-CUSTODY DEFENDANT RECEIVING, HOLDING, AND TRANSPORT

- 8.A Objectives
- 8.B Planning Criteria
- 8.C Functional Overview
- 8.D Program Components
- 8.E Technical Criteria
- 8.F Electronic Detention Control System

- 9 Public Spaces
- 10 Building Support Services

9.2 Card Reader–Controlled Detention Doors (Card In/Out)

- a. When the DCS is in night mode, central holding perimeter doors may be controlled by card readers to facilitate cleaning, maintenance, and inspection. Provide card reader control through an interface between the access control system and the DCS. In no case shall a card access control system be used for primary control of operation of in-custody detention areas.
- b. In DCS day mode, the holding area perimeter door shall be locked and closed. In this mode, the DCS shall reject unlock signals from the access control system.
- c. For DCS night mode, the entry and exit sequence of operation shall function as follows:
 - Door is locked and closed.
 - On a valid entry or exit card read, the access control system signals the DCS to unlock the door and bypass door and lock position sensor alarms.
 - After the door unlocks and is opened, the DCS detects the *open* door status and releases the latch-bolt to relock the door when closed.
 - When the door is closed and locked, the DCS detects the *closed* door status and rearms door and lock position sensors.

10. Court Holding Vestibule

Court holding vestibule doors include the secure elevator door, cell doors, and courtroom sound lock doors. Court holding vestibule doors are monitored and controlled from the DCS touchscreen computer.

- a. When a CSO requests in-custody transport to a courtroom, the in-custody shall be transported to the court holding vestibule in the secure elevator.
- b. When a CSO communicates by intercom, a graphic of the court holding vestibule shall be automatically displayed on the DCS touchscreen display, and a vestibule surveillance camera feed shall be automatically displayed on a video monitor.
- c. When a CSO communicates by other means, the DCR operator selects an appropriate graphic from the DCS touchscreen, which shall display a graphic map of the vestibule on the touchscreen and a vestibule surveillance camera feed on a video monitor.
- d. When the DCS confirms that all court holding vestibule doors are secure, the secure elevator door may be opened through the DCS touchscreen. If any holding vestibule door is not secure, the secure elevator door shall not be able to be opened from the DCS. When the DCR confirms that other court holding vestibule doors are secure, the cell door may be opened through the DCS touchscreen. If other holding vestibule doors are unsecured, the cell door may not be opened.
- e. When the DCR confirms that other court holding vestibule doors are secure, the courtroom sound lock door may be opened from the DCS touchscreen display.
- f. If other holding vestibule doors are unsecured, the courtroom sound lock door may not be opened. After the officer accesses the court holding door, manual doors are closed by the officer, and motorized doors are closed via the DCS.

11. Secure Interview Rooms

Call buttons located in the holding area interview rooms provide notification to the DCR that an in-custody is ready to be escorted back to his or her cell. These doors are monitored and controlled as a central holding door. The CSO should have the ability to control both sides of the secure interview room at the courtroom.

12. Secure Circulation and Elevators

- a. Secure elevators are controlled from DCS touchscreen computers. The DCS monitors elevator door and floor status and controls floor selection and door operation. The DCS touchscreen shall incorporate a virtual elevator return panel that displays elevator location and status and duplicates the elevator return panel controls in each cab.
- b. When an officer communicates with the DCR by intercom requesting secure elevator access, a graphic map of the elevator floor and virtual return panel shall be automatically displayed on the DCS touchscreen computer, and the elevator surveillance camera feed shall be automatically displayed on a video monitor.
- c. When an officer communicates with the DCR by other means, the DCR operator may select an appropriate graphic map from the DCS touchscreen computer, which shall display a graphic of the elevator floor and virtual return panel on the touchscreen and the elevator surveillance camera feed on a video monitor.
- d. When the elevator is clear and secure, the DCR operator selects the requested floor. If the court holding vestibule is secure, the elevator door icon may be selected to open the door. If any court holding vestibule door is unsecured, the elevator door shall not be able to be opened. Secure elevator doors must not automatically open upon arrival to a floor.
- e. When in-custody passengers enter the elevator, the DCR operator closes the elevator door and selects a destination floor from the DCS touchscreen computer. The touchscreen shall display the elevator location while in transit.
- f. When the elevator arrives at the selected floor, the touchscreen and surveillance camera displays shall be automatically updated to view the selected floor.
- g. If the court holding vestibule is secure, the elevator door icon may be selected to open the door. If any court holding vestibule door is unsecured, the elevator door shall not be able to be opened until secure. After all persons have exited, the elevator door is closed from the DCS.

13. Holding Control

13.1 DCS Workstations

- a. Locate multiple DCS workstation positions at the DCR for redundancy. DCS workstation positions include a modular workstation desk, DCS touchscreen and video surveillance system computers, video surveillance system monitors, and an intercom master station.
- b. The workstation positions must also support control room equipment required by other sections of the *Facilities Standards*.

13.2 Unified Control

- a. DCS computers shall be capable of controlling all holding areas to eliminate operational conflicts between workstations.
- b. DCS computers shall be capable of providing unified control when independent control is not required.

DIVISION ONE: DESIGN CRITERIA

- 1 General Principles
- 2 Courthouse Organization
- 3 Site Design
- 4 Courthouse Security
- 5 Court Set
- 6 Jury Facilities and Court Administration
- 7 Special Services

8 IN-CUSTODY DEFENDANT RECEIVING, HOLDING, AND TRANSPORT

- 8.A Objectives
- 8.B Planning Criteria
- 8.C Functional Overview
- 8.D Program Components
- 8.E Technical Criteria
- 8.F Electronic Detention Control System

- 9 Public Spaces
- 10 Building Support Services

13.3 Independent Control

A dedicated juvenile holding DCS computer shall be provided at facilities requiring independent juvenile holding area control. Provide a fully functional designated juvenile DCS touchscreen computer capable of providing unified control, with operational control limited to the juvenile holding area.

13.4 Day and Night Mode

- a. For day mode, when the DCS locks all holding area doors, limit holding area access only through the DCS touchscreen control or with a key.
- b. For night mode, provide an interface between the access control system and the DCS to control select central holding perimeter doors and holding area doors by card reader. The system shall allow DCS to unlock designated holding area interior doors to facilitate cleaning, maintenance, and inspection.

13.5 Detention Office Monitoring

Detention remote viewing stations may be required at holding area support offices to monitor holding area cameras. Detention office DCS computers do not provide holding area control.

13.6 Fail-Over Holding Control

- a. In larger facilities, you may be required to provide additional fail-over DCS control stations at alternative locations, such as an SOC, to ensure holding area control redundancy and continuity if DCS operation is not possible from the DCR.
- b. Locate fail-over equipment to maintain and ensure holding area privacy and in areas where public viewing of detention surveillance cameras is not possible.

14. Operational Descriptions and Installation Criteria**14.1 DCS Core Equipment**

- a. Provide core DCS equipment, including file server, central processing unit, touchscreen interfaced computers, PLCs, intercom exchange, intercom master stations and substations, and a distributed antenna system for two-way radio communication.
- b. Provide DCS network communications that utilize a converged building Transmission Control Protocol (TCP)/Internet Protocol (IP) network including virtual local area networks to provide secure DCS communications.
- c. The PLC and intercom servers, integrated with the court facility video surveillance system (VSS) headend equipment, form the DCS. Systems integration shall be via the court network and provide seamless monitoring, control, and operation of detention areas from the DCR and other designated locations.
- d. DCS integration with the video surveillance system shall provide automated camera call-up and display based on DCS commands, intercom substation calls, and holding area alarms.
- e. Integrate the DCS with secure driveway gates and barrier gate arms to provide gate control from the DCR. The DCS gate position sensor alarms monitored by the card access control system shall be bypassed while the gates are under DCS control.
- f. Rack-mount the DCS file server and intercom exchange server in an MDF or IDF room on the same floor as the DCR.

14.2 DCS Programmable Logic Controller

- a. Programmable logic controller shall be provided via standardized PLCs. PLCs are the only acceptable means of providing DCS monitoring and control of detention doors. PLCs shall be tailored to each facility's size and unique requirements. PLCs interface all DCS system inputs and outputs for operator control from DCS touchscreen computers.
- b. For local PLCs, the central holding area PLC equipment shall be located outside the holding area perimeter. Locate the PLC server in a fully enclosed and locked equipment rack. Wall-mount local (central holding) PLCs, power supplies, interface cabinets, and network connections in the same room as the PLC and intercom servers.
- c. For remote PLCs, wall-mount remote (i.e., court holding) PLCs, power supplies, interface cabinets, and network connections in an IDF room on the same level as the remote holding area they control.
- d. For PLC inputs, include vehicle and pedestrian door position monitoring, latch bolt position monitoring, gate position and safety sensor monitoring, secure elevator floor status and door position monitoring, and inputs from interfaces to other systems.
- e. For PLC outputs, include vehicle and pedestrian door control, secure elevator call and floor select control, secure elevator door control, vehicle gate control, and outputs to interfaces with other systems.

14.3 DCS Touchscreen Interface

Locate the DCS touchscreens on the workstation furniture monitor tree with the VSS monitors so that they are easily accessed from a seated or standing position.

14.4 DCS Door Monitoring

- a. Provide holding area door latch monitor switches to confirm that doors are latched.
- b. Provide holding area door position monitoring with triple-bias high-security detention-grade magnetic door position switches.
- c. Provide commercial-grade surface-mounted position switches to monitor vehicle door position.
- d. Provide commercial-grade surface-mounted position switches to monitor vehicle gate position.
- e. Door monitoring circuits must be home run from each door position switch to a PLC input via an interface termination cabinet in the same room as the PLC equipment. Door monitoring and lock status may share the same PLC input circuit.

14.5 DCS Lock Control

- a. Provide PLC outputs that control DCS locks at sally ports, central holding, secure circulation, and courtroom holding areas.
- b. PLC outputs switching 120VAC locks shall be National Electrical Code Class 1-rated electrically isolated relay circuits to protect PLC outputs and shall have individually fused disconnect terminal blocks to prevent a short circuit on one door lock circuit from affecting any other doors on the same branch circuit.
- c. Shield and isolate all connections to ensure a "finger safe" maintenance environment.

DIVISION ONE: DESIGN CRITERIA

- 1 General Principles
- 2 Courthouse Organization
- 3 Site Design
- 4 Courthouse Security
- 5 Court Set
- 6 Jury Facilities and Court Administration
- 7 Special Services

8 IN-CUSTODY DEFENDANT RECEIVING, HOLDING, AND TRANSPORT

- 8.A Objectives
- 8.B Planning Criteria
- 8.C Functional Overview
- 8.D Program Components
- 8.E Technical Criteria
- 8.F Electronic Detention Control System

- 9 Public Spaces
- 10 Building Support Services

14.6 DCS Video Surveillance System

- a. Include in the DCS video surveillance system client computers, monitors, and cameras as an extension of the court facility VSS. Refer to chapter 4, Courthouse Security, for specific information regarding the court facility VSS.
- b. Video surveillance monitoring shall be password protected to prevent unauthorized viewing and control of detention cameras. Authorized monitoring of detention cameras outside detention areas must not be observable by the public.
- c. Cameras in common detention areas and secure elevators must be vandal resistant. Cameras in detention cells must be high-security detention type. Cameras must be installed in compliance with the requirements of this chapter. In all other respects, detention-area cameras must be compatible and consistent with the building VSS design.
- d. VSS client computers must be located in secure cabinets within the DCR modular workstation furniture. VSS monitors will be located on a monitor tree, oriented to allow easy viewing and to minimize operator fatigue. Large-format monitors mounted on walls are also acceptable.
- e. The VSS system must provide camera call-up at DCR touchscreen computers using a graphic icon for each camera.

14.7 DCS IP-based Intercom System

- a. Include in the intercom system a rack-mounted intercom exchange and modular expansion chassis equipment rack mounted in an MDF or IDF room on the same level as the DCR.
- b. The intercom substations shall use Power over Ethernet network connections from MDF and IDF rooms to each intercom field device.
- c. The intercom system shall provide call initiation from the DCS touchscreen computers, master stations, and substations for two-way voice communications between master stations and substations.
- d. The intercom system shall provide monitoring of substations from DCS touchscreen computers and master stations.
- e. The intercom system shall provide notification of call button activation at master stations and DCS touchscreen computers.
- f. The intercom system shall provide annunciation of substation calls at DCR touchscreen displays with a graphic icon and audible notification. Intercom substation calls may be placed from the DCR touchscreen computer by selecting a graphic substation icon on the touchscreen.
- g. The intercom system shall interface with VSS for automatic display of cameras viewing the calling substation each time a call is initiated from that substation.
- h. In sally port, central holding, secure circulation, and courtroom holding area intercom substations, incorporate one-touch push-button operation, vandal-resistant construction, and integral tamper alarms.
- i. Locate sally port, central holding, secure circulation, and courtroom holding area detention door intercom substations preferably in the detention door frames.

- j. Locate intercom master stations adjacent to DCR touchscreen monitor at DCR modular workstation furniture, and incorporate an alphanumeric display and programmable push-button keypad.

14.8 DCS Workstations

- a. Modular or systems furniture shall be provided at DCS workstation locations that are secure or located in a DCR. Workstation monitors shall be uniform in size and specification and located on a monitor tree.
- b. Detention-grade furniture shall be provided at DCS workstation locations that are unsecured or located within a detention area. Equipment and desk accessories shall be minimized and shall be securely attached to the furniture.
- c. Project requirements should include early and periodic review of the detention furniture with BSCC. Moveable, temporary, or breakable furniture (e.g., plastic chairs) that can be tampered with, thrown, or broken for use as a weapon or provide a risk of ligature is subject to BSCC inspection and approval. Furniture mockup is recommended.

15. Infrastructure Wire and Cable

- a. Protect DCS wire and cable in metallic raceway, conduit, enclosed cable tray, or enclosed cable ladder, where exposed, readily accessible, or inside walls. Plastic raceway is unacceptable.
- b. All TCP/IP network cabling and connectivity shall be in accordance with chapter 17, Network and Communication Systems, and chapter 18, Audiovisual Systems.
- c. For point-to-point cabling:
 - Low-voltage power cabling shall be two-conductor, 18 American Wire Gauge (AWG), stranded and unshielded. Typical applications include 24-volt direct current lock power.
 - Alarm point cabling will be one twisted pair, 18 AWG, stranded and unshielded. Typical applications include door contacts and latch monitoring.
- d. VSS Cameras
 - Interior IP camera cabling shall be in accordance with chapter 17, Network and Communication Systems, and chapter 18, Audiovisual Systems.
 - Analog cameras shall use unshielded twisted pair (UTP) interfaces to transmit camera and control signals over a network cabling infrastructure.
 - Secure elevator cameras shall utilize converters for IP cameras to transmit camera signals via coaxial or twisted pair within the traveler cable.
 - Exterior camera signal cabling shall be fiber optic unless the routed distance is within the maximum length allowed in chapter 17, Network and Communication Systems, for copper cable.

16. Infrastructure Power

- a. Normal power shall be provided for DCS components with a low-voltage power supply incorporating a battery backup power source.
- b. For detailed uninterruptible power supply (UPS) requirements, see chapter 15, Electrical Criteria.

**DIVISION ONE:
DESIGN CRITERIA**

- 1 General Principles
- 2 Courthouse Organization
- 3 Site Design
- 4 Courthouse Security
- 5 Court Set
- 6 Jury Facilities and Court Administration
- 7 Special Services
- 8 IN-CUSTODY DEFENDANT RECEIVING, HOLDING, AND TRANSPORT**
- 8.A Objectives
- 8.B Planning Criteria
- 8.C Functional Overview
- 8.D Program Components
- 8.E Technical Criteria
- 8.F Electronic Detention Control System
- 9 Public Spaces
- 10 Building Support Services

DRAFT

DIVISION ONE: DESIGN CRITERIA

9

PUBLIC SPACES

SECTION	TOPIC	PAGE
9.A	Objectives	9.2
9.B	Primary Building Entrance	9.2
9.C	Public Lobby	9.2
9.D	Courtroom Public Waiting Areas	9.5

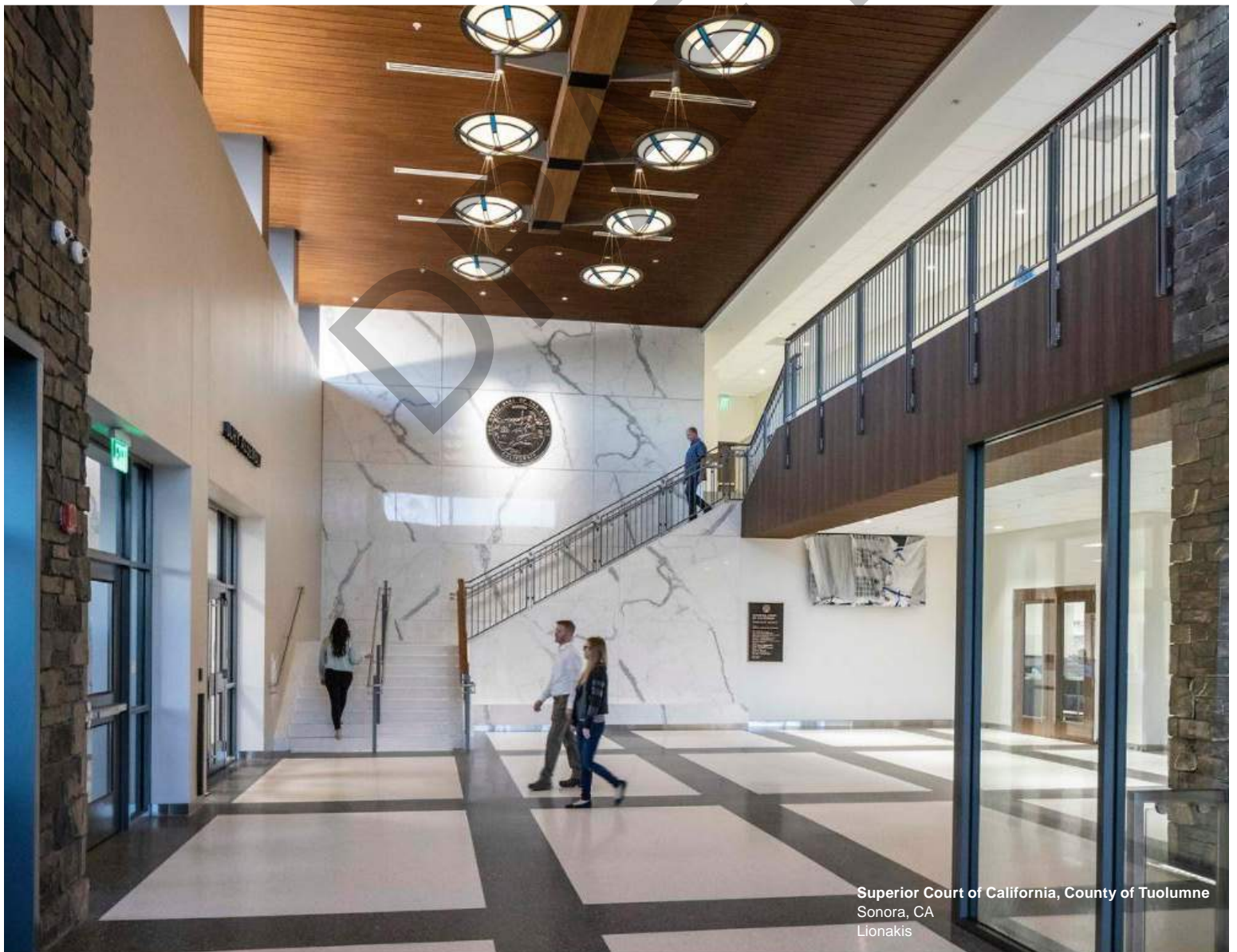

Superior Court of California, County of Tuolumne
Sonora, CA
Lionakis

Public spaces provide courthouse visitors with a first impression of the justice system and the court facility.

Public Courthouse Spaces

- Primary Building Entrance
- Public Lobby, Including Security Station and Information Counter
- Courtroom Public Waiting Areas

9.A OBJECTIVES

Planning and design of public spaces are critical to the successful operation of a courthouse. Public spaces should provide simple and clear movement of visitors and staff into and throughout the courthouse, while limiting access to non-public zones. Public spaces should also provide an open and spacious experience for users—who are often under stress—and convey the importance and authority of the courts.

Strategically placed, clear, and legible graphics and signage—visible on entry—will provide first-time visitors with information about where to find various functions and how to get there. Wayfinding techniques shall provide visual cues about the location of important public spaces and services.

The court facility must maintain a safe and secure environment for all people and property. Court security includes active and passive measures, encompassing design, technology, and operations. See chapter 4, Courthouse Security.

9.B PRIMARY BUILDING ENTRANCE

The front door of each court building has important symbolic and functional attributes. This main ceremonial entrance is the single point of entry for staff, visitors, and the public.

- a. Provide a single primary entry with universal access.
- b. Provide an attractive and user-friendly environment as a first impression to court visitors and staff.
- c. Design the entrance to accommodate peak-hour lines of prospective jurors and courthouse visitors through the entrance and entrance doors.
- d. Because lines may extend out the entrance door, provide outside protection from inclement weather, including sun, wind, and rain. Some climates may require a vestibule. Refer to chapter 11, Architectural Criteria.
- e. Building entries, especially the main public entry, must accommodate persons with disabilities in the same manner as the general public. Entry doors shall meet the door closer requirements of applicable codes. Power-assist doors or balanced doors shall be provided. Power-assist doors are preferred because they can be used when needed but are a universally accessible solution.

9.C PUBLIC LOBBY

1. Lobby Requirements

The public lobby serves as the focal point for the building and provides visual orientation to the other areas through visual cues and signage. See figure 9.1.

- a. Provide a public lobby sized for a queuing area sufficient to accommodate the volume of people entering the courthouse and weapons screening stations. Give attention to integrating the security screening stations into the lobby design to avoid the appearance of an intrusion or afterthought.
- b. Provide security cameras throughout public areas, with special emphasis on weapons screening to record the public entering the facility and receiving their belongings once they have gone through weapons screening.
- c. Provide clear signage and graphics immediately upon arrival in the courthouse public lobby. Many courthouse visitors will require directions to courtrooms or hearing rooms.



Figure 9.1 Public Lobby, Superior Court of Siskiyou County, Yreka

- d. Provide large, easily readable court calendar monitors. Areas where courtroom assignments are posted must be accessible without impeding the security screening process or blocking public circulation paths.
- e. Provide climate and glare control for building management staff. Consider finish materials to control the glare throughout the space.

2. Security Screening Station

- a. Building users and staff shall enter the facility through a public entry screening station. See figure 9.2. Screening of the public occurs in the building lobby. Provide one security screening station, or lane, for full-time operation. See figure 9.3. Provide additional lanes as required to operate during peak usage—in mornings and after lunch, for example, during high-volume jury return flow. The number of lanes is determined based on a metric used by the Judicial Council planning team in conjunction with the court during early design stage.



Figure 9.2 Screening Station, Sutter County Superior Courthouse, Yuba City

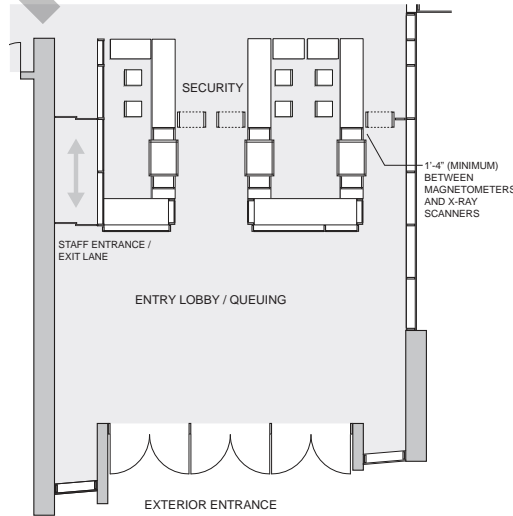

Figure 9.3 Screening Station Diagram

DIVISION ONE: DESIGN CRITERIA

- 1 General Principles
- 2 Courthouse Organization
- 3 Site Design
- 4 Courthouse Security
- 5 Court Set
- 6 Jury Facilities and Court Administration
- 7 Special Services
- 8 In-Custody Defendant Receiving, Holding, and Transport

9 PUBLIC SPACES

- 9.A Objectives
- 9.B Primary Building Entrance
- 9.C Public Lobby
- 9.D Courtroom Public Waiting Areas

- 10 Building Support Services

During the early planning and design phases, involve the sheriff's department or court security officers to ensure compliance and cooperation from planning through design and occupancy.

- b. Screening stations shall include space for the following:
 - An interior or covered area for queuing of the projected peak volume of people entering the building. Distance between the security screening station and the building entrance is recommended to be at least 20 linear feet.
 - A magnetometer, or metal detector, through which visitors pass for detection of metal objects. The opening shall be 32" clear to accommodate wheelchairs or mobility devices.
 - An x-ray scanner for screening contents of visitor briefcases, handbags, and personal possessions, paired with sufficient project-specific roller-table assemblies for the input and output of packages. There shall be a minimum of 1'4" distance between magnetometers and x-ray scanners.
 - Where multiple screening lines are required, a ratio of one magnetometer per pair of package screening units (1:2), subject to confirmation with a project-specific security operations program.
 - A table or counter for secondary inspection of scanned items.
 - A magnetic-wand inspection area.
 - Security staff posts to assist individuals through the magnetometer screening and x-ray scanning. In multiportal screening areas, a third security post may be needed to oversee the screening process and assist security staff. Provide power, data, and voice communications to the security post.
- c. Magnetometers, x-ray scanners, and other equipment shall not be affixed to built-in casework to allow for ease of equipment replacement when needed.
- d. Design the screening area to be consistent with the court public spaces and project a positive first impression to court visitors. Do not make screening equipment the main focus of the space. Provide a casework screen for the scanning position, constructed of durable materials to withstand the stress of a high-traffic area, and lined with nonricochet, bullet-resistant material that will absorb multiple firings of a large-caliber handgun.
- e. The accessible path of travel shall include the lobby security screening area. Wheelchair users shall not travel a separate and nonequivalent path through the screening process area. Persons with disabilities shall pass through a magnetometer, along with the general population. Space must be provided to allow bypass of the magnetometer for people with implanted medical devices that may be affected by magnetic fields.
- f. In some cases, it may be necessary to provide gun lockers for law enforcement officers entering the facility, consistent with local security procedures.
- g. Design each security screening area to allow visual observation by security staff of all public exits to ensure that individuals entering the building do not circumvent the screening process. Directionally sensitive motion-detection systems with audiovisual alarms or electronic turnstiles may be used to deter entry of individuals through the exit lanes.
- h. Locate staff-only entrances or exits at a staffed security screening station only, to avoid compromising overall building security and increasing security costs.

3. Information Counter

- a. A clearly identified information display screen with an optional desk space shall be used to provide direction and basic information to individuals unfamiliar with the court facility or court system. The desk shall be provided if the court plans to have reception staff in the lobby. Refer to figure 9.4. The information screen must be located in a highly visible place near the main entrance but beyond the screening area. Design the information area consistent with the public spaces. The screen shall display the courthouse map and court calendar.
- b. The information area must be used in conjunction with directional signage to provide courthouse visitors information about location of services.
- c. If a kiosk is used, it may be an automated system with touchscreen technology or a combination of automated signage with a staff member so that the kiosk still provides information if the staff member is not present. If the counter is staffed, provide adequate accessible workspace. Staff may be volunteers.

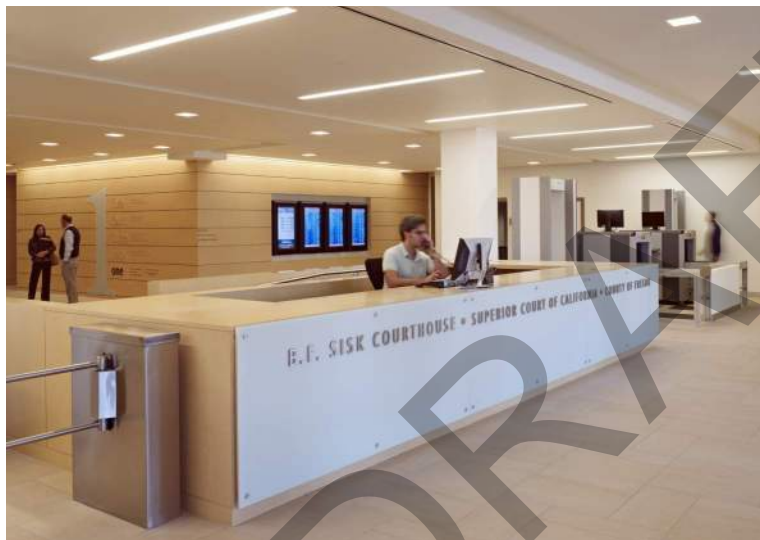

Figure 9.4 Information Display Screens Beyond Information Desk, B.F. Sisk Courthouse, Fresno

9.D COURTROOM PUBLIC WAITING AREAS

- a. Public waiting areas shall include sufficient comfortable seating and be located near areas of highest public use, with easy access to restrooms and water fountains. The water fountains shall be combination units for drinking and bottle filling and shall be ADA compliant. Provide natural light in waiting areas, if possible.
- b. Corridors may be used as public waiting areas if they are wide enough to accommodate bench seating and if a vestibule with a sound lock is provided at courtroom entrances.
- c. Waiting areas shall be proportional to the population served. Family law, arraignment, traffic, and juvenile courts require larger public waiting areas.

DIVISION ONE: DESIGN CRITERIA

- 1 General Principles
- 2 Courthouse Organization
- 3 Site Design
- 4 Courthouse Security
- 5 Court Set
- 6 Jury Facilities and Court Administration
- 7 Special Services
- 8 In-Custody Defendant Receiving, Holding, and Transport
- 9 PUBLIC SPACES
- 9.A Objectives
- 9.B Primary Building Entrance
- 9.C Public Lobby
- 9.D Courtroom Public Waiting Areas
- 10 Building Support Services

DRAFT

10

DIVISION ONE: DESIGN CRITERIA

BUILDING SUPPORT SERVICES

SECTION	TOPIC	PAGE
10.A	Janitor Closets	10.2
10.B	Loading Dock	10.2
10.C	News Media Functions	10.3
10.D	Mailroom	10.3
10.E	Maintenance Shops and Office	10.3
10.F	Storage	10.3
10.G	Mechanical Equipment Enclosures	10.4
10.H	Fire Alarm and Emergency Communication System Control Room	10.4



Superior Court of California, County of Mono
Mammoth Lakes, CA
Mark Cavagnero Associates

Building support services ensure that necessary routine maintenance and operational functions occur on a daily basis within the court facility. Support services include deliveries, collection and removal of trash or recycling, and storage of fixtures and equipment.

The character and size of building support spaces shall be determined during programming and early design phases, with input from the Facilities Services building operations staff.

10.A JANITOR CLOSETS

Provide janitor closets on each floor of the court building, except in small facilities or on floors with limited occupied spaces. Include a service sink, tool racks, water-tight wall covering with high-impact resistance, and wall-mounted shelving. All janitor closets should be separately ventilated and exhausted, negatively pressurized to adjacent spaces. Access to janitor closets may be from within public restrooms, but this is not the preference.

In large facilities, provide a janitorial storage room for central inventory of supplies. Locate the room near staff locker rooms and the management office.

10.B LOADING DOCK

- a. Large facilities require a raised loading dock to accommodate delivery, trash, and recycling trucks, as determined by the program. Some facilities may use an on-grade loading area equipped with a motorized platform dock lift. Large interstate trailer rigs need not be accommodated in the loading dock, but a staging area shall be provided so that all deliveries can be scanned or examined before entering the building.
- b. The building location within the site circulation system shall allow easy delivery and efficient distribution of goods throughout the facility:
 - Locate the loading dock near the freight elevator but away from general office areas of the court.
 - Locate air intake ducts to avoid intake of fumes from idling trucks.
- c. Access from the street must be through a restricted vehicle circulation system. The driveway, loading dock, loading dock apron, and exterior staging areas must be within the security perimeter and fully enclosed by fencing.
- d. Provide closed-circuit television to monitor the driveway, loading dock, loading dock apron, and exterior staging area. Provide a telephone or other annunciation system at the gateway to the service driveway. If the gate is remotely operated, provide a manual backup system. Refer to chapter 4, Courthouse Security.
- e. Office supplies can be delivered on an as-needed basis. Provide space for pallet delivery and storage near the loading dock.
- f. Dedicate one truck bay within a secure loading area to trash and recycling. This area will include collection and compaction bins and locked, covered roll-off containers.
 - Include a covered area for temporary storage of delivered supplies, equipment, and recyclable materials.
 - Provide a file shredding area near the loading dock. If this process is contracted out, provide a secure area to store materials awaiting pickup.

10.C NEWS MEDIA FUNCTIONS

If requested by the court, the courthouse must accommodate the media, inside and outside the facility. For technical requirements, refer to chapter 17, Network and Communication Systems, and chapter 18, Audiovisual Systems.

1. Interior Media Area

If requested by the court, provide an interior space for use by news media personnel, off a public corridor, not necessarily near the courtrooms, with appropriate power, data, and telecommunications support systems, including audio, video, or other feeds to the main distribution frame. The news media room may be multipurpose, but must be available for the news media in courthouses, especially during high-profile cases.

2. Exterior Media Area

If requested by the court, designate an exterior area with parking for multiple satellite trucks. If possible, the area should face south for satellite exposure. The location can be beyond building security standoff. For urban areas where no parking can be designated for satellite trucks, provide an exterior connection box for video and audio accessibility on the south side of the building or at the loading dock.

10.D MAILROOM

Most facilities receive daily mail and packages through the public entry, where an x-ray machine may scan them. A large facility may require a dedicated room for receiving and opening mail, with x-ray package screening and biohazard control capabilities.

Locate the mailroom and mail opening room near the central receiving or loading dock and near a service or freight elevator, to allow staff to transport mail to other parts of the building.

10.E MAINTENANCE SHOPS AND OFFICE

Provide an office for court-based maintenance staff. The office shall be sized to accommodate workstations for project and facilities management staff and space for visitors. Provide furnishings for storing and reviewing building plans and for reference catalog shelving. Locate a staff restroom for easy access by maintenance staff. Locate the office in the basement or in a nonpublic location.

In large facilities, locate a maintenance shop on the ground floor, near the freight elevator. Provide walls that minimize noise transmission. Also, provide a lunchroom for custodial workers.

10.F STORAGE

In medium and large facilities, provide a furniture storage area near the freight elevator. Provide shelving for attic stock. Building supplies and materials, such as carpet, shall be stored there. Locate this storage area adjacent to the maintenance shop and office.

DIVISION ONE: DESIGN CRITERIA

- 1 General Principles
- 2 Courthouse Organization
- 3 Site Design
- 4 Courthouse Security
- 5 Court Set
- 6 Jury Facilities and Court Administration
- 7 Special Services
- 8 In-Custody Defendant Receiving, Holding, and Transport
- 9 Public Spaces
- 10 BUILDING SUPPORT SERVICES
- 10.A Janitor Closets
- 10.B Loading Dock
- 10.C News Media Functions
- 10.D Mailroom
- 10.E Maintenance Shops and Office
- 10.F Storage
- 10.G Mechanical Equipment Enclosures
- 10.H Fire Alarm and Emergency Communication System Control Room

Refer to chapter 17, Network and Communication Systems, for information on telecommunications and server equipment rooms.

Refer to chapter 20, Fire Protection Criteria.

10.G MECHANICAL EQUIPMENT ENCLOSURES

- a. Mechanical and electrical equipment, outside of the nominal building envelope, shall be protected from weather and environmental elements within an architectural equipment enclosure that allows suitable access for maintenance personnel. An evaluation shall be conducted for prevalent site elements such as wind, sand, and rain to determine enclosure requirements. An equipment enclosure on a building roof shall be integrated with the overall building design and comply with other sections of these standards. Enclosures in the form of penthouses are preferred, but not required, depending on the size and type of equipment. If a penthouse is not provided, exterior-grade equipment and visual screens shall be provided.
- b. An evaluation shall be conducted to determine the potential for the migration of Legionella between adjacent rooftop cooling towers and the cooling tower in the project. Cooling towers shall be enclosed if the evaluation deems it necessary.
- c. Equipment enclosures on a building roof shall be accessible via a permanent dedicated industrial stair from the top occupied building floor to the roof. It is preferable but not required for the stair to terminate inside the equipment enclosure. The stair shall be wide enough to afford access for maintenance personnel carrying hand tools or small parts. Ladders shall not be employed to provide access to equipment enclosures.
- d. Air-handling unit outside-air intakes, relief air, and exhaust air shall be ducted directly to the outside of the roof equipment enclosure. Toilet (or other product-conveying) exhaust fans should not be located within the roof equipment enclosure.
- e. Emergency generator sets (see 15.C, Emergency and Standby Power Systems) are generally exempt from the above enclosure standard, if the equipment is in the building or vault. Equipment that needs to be located outside shall be screened, but not enclosed, per above. That equipment includes:
 - Water backflow and detector check valves;
 - Irrigation controllers;
 - Utility company electrical transformers; and
 - Battery energy storage systems, if photovoltaic and energy management systems are included in the project.

10.H FIRE ALARM AND EMERGENCY COMMUNICATION SYSTEM CONTROL ROOM

Emergency communication system control equipment that is installed in non-high-rise buildings must be located within a room separated from the remainder of the building by not less than a one-hour fire resistance rated fire barrier with one-hour fire resistance rated opening protection. This room must be located after consultation with the authorities having jurisdiction (fire department) and be approved by the Judicial Council. The room must be a minimum of 100 square feet, with a minimum dimension of 8'.

DIVISION TWO: TECHNICAL CRITERIA

- 11 Architectural Criteria
- 12 Structural Criteria
- 13 Mechanical Criteria
- 14 Building Management System Criteria
- 15 Electrical Criteria
- 16 Lighting Criteria
- 17 Network and Communication Systems
- 18 Audiovisual Systems
- 19 Acoustical Criteria
- 20 Fire Protection Criteria

DRAFT

DIVISION TWO: TECHNICAL CRITERIA

11

ARCHITECTURAL CRITERIA

SECTION	TOPIC	PAGE
11.A	Objectives	11.2
11.B	Architectural Criteria	11.2
11.C	Building Elements: Exterior Construction	11.2
11.D	Building Elements: Interior Construction	11.9
11.E	Signage	11.17



Courthouses are public buildings emblematic of our judicial system. As such, they should use architectural elements and materials that are dignified, yet practical, and durable enough to withstand sustained public use.

Architectural criteria provide performance standards for selected architectural components, building assemblies, and finishes.

11.A OBJECTIVES

The performance standards and criteria listed in this chapter provide functional solutions to objectives listed in chapter 1, General Principles: functional usefulness, physical durability, maintainability, accessibility, sustainability, and energy efficiency.

11.B ARCHITECTURAL CRITERIA

California court facilities shall use practical and durable materials and finishes in all elements, and exhibit consistency in the design and use of materials throughout. The performance of architectural elements shall be consistent with the functional lifetime defined in chapter 21, Life Cycle Cost Analysis, and the selection of elements, systems, or materials shall be consistent with the construction budget and the imperative to control overall maintenance and operation costs of the building over its lifetime. Minimize variation in the number of materials used in a building.

11.C BUILDING ELEMENTS: EXTERIOR CONSTRUCTION

Design the exterior building envelope—including roofs, exterior walls, foundations, retaining walls, and door and window assemblies—to be weatherproof. Design to exclude leaks and other defects for all moisture protection systems, including exterior sealants, vapor barriers, underslab moisture barrier systems, exterior cladding systems, roofing, and waterproofing. All window designs must anticipate water infiltration and condensation and provide means to direct water to the exterior and allow it to escape.

1. Building Enclosure Commissioning (BECx)

- a. The purpose of BECx shall be to ensure integrity of four critical barrier systems of the building envelope: water, thermal, vapor, and air barriers. Do not use one barrier to serve for all four barrier systems, so that over time a failure of one system will not compromise all four systems.
- b. The project shall achieve air tightness to the extent required by the California Energy Code.
- c. A commissioning authority or agent (CxA) shall be responsible for BECx plan development, thorough review of progressive design drawings and specifications, review of building envelope value engineering efforts, and shall participate in inspections and testing during the construction phase and one-year warranty review.
- d. The standard for BECx shall be ASTM E2813, Standard Practice for Building Enclosure Commissioning. The standard test for air infiltration shall be ASTM E3158, Standard Test Method for Measuring the Air Leakage Rate of a Large or Multizone Building, or ASTM E779-19, Standard Test Method for Determining Air Leakage Rate by Fan Pressurization. In addition, the CxA shall specify as appropriate other standards for shop and/or field-testing of building envelope systems.

2. Wind Analysis

The forces of wind and weather shall be considered in architectural design based on specific project site conditions. A pedestrian-level wind analysis may be required to determine wind effects on the court building and surrounding buildings, sidewalks, the plaza, and entrances and to determine the need for a main entry vestibule. The effects of wind should also be

considered in the selection of entry door systems and hardware to ensure that doors will securely latch. The recommendations of a wind analysis shall be addressed by the architectural design. Snow and ice accumulation analysis may be required for court buildings in cold regions of the state. An air-quality wind analysis may be required to determine the optimum location of air intakes and exhaust stacks, but in all cases, building exhausts should be located away from building entries and ventilation air intakes.

3. Exterior Building Walls

The exterior wall design shall present a consistent image, character, and permanence. Scoring, control joints, and other wall plane relief shall be considered and incorporated into the design. The building cladding system requires high-quality, long-lasting, durable components that can accommodate movement, are designed for low maintenance, and have a functional lifetime as defined in required tool 1, table T1.1. The use of anti-graffiti coatings is encouraged at locations vulnerable to graffiti and where suitable for the substrate.

3.1 Moisture and Damp Proofing

- a. Provide an exterior envelope system, including roofing, that is a complete weather- and moisture-proof assembly that will prevent infiltration into the building's occupied or unoccupied areas.
 - Design the building exterior systems to prevent the introduction or long-term growth of mold or other pathogens that could adversely affect the indoor environmental quality or work environment.
 - Design exterior wall systems that provide two distinct lines of protection against water penetration and one line of protection against air infiltration.
 - Provide a complete moisture- and damp-proofing system at all concrete slabs on grade, retaining walls, and other below-grade structures. No wooden elements shall be exposed to rain.
- b. Specifications shall include a section for moisture mitigation before flooring installation, if required based on relative humidity (RH) testing. All new interior concrete substrates shall be tested per the current edition of the ASTM F2170 test method using in situ probes as a means of conducting relative humidity testing of the concrete slabs.

If the RH test results indicate a saturated slab condition, only a two-component resin-based membrane-forming moisture mitigation system that meets the full intent of the current edition of ASTM F3010 shall be allowed. The product requirements shall have a vapor permeance no greater than 0.1 grain per hour per square foot per inch of mercury (0.1 grain/hour/ft²/inch Hg) (perm) when the product is tested in accordance with ASTM E96 when applied at the recommended thickness designated by its manufacturer.

3.2 Barrier Walls and Drainage Plane Walls

The defining feature of a barrier wall is that protection from sun, water, and wind is provided at the single outermost surface of the wall, whereby the system that faces the environmental forces is the same system that repels water. By contrast, a drainage plane or cavity wall has the primary water-resistant weather line behind the exterior surface system, which provides the environmental protection, and a secondary water barrier.

Traditional barrier walls rely on mass to absorb moisture and evaporate it slowly to the exterior and on physical shielding—such as roof overhangs, window setbacks, and drip edges—to protect vulnerable joints from weather exposure.

DIVISION TWO: TECHNICAL CRITERIA

11 ARCHITECTURAL CRITERIA

- 11.A Objectives
- 11.B Architectural Criteria
- 11.C Building Elements: Exterior Construction
- 11.D Building Elements: Interior Construction
- 11.E Signage
- 12 Structural Criteria
- 13 Mechanical Criteria
- 14 Building Management System Criteria
- 15 Electrical Criteria
- 16 Lighting Criteria
- 17 Network and Communication Systems
- 18 Audiovisual Systems
- 19 Acoustical Criteria
- 20 Fire Protection Criteria

- a. Contemporary surface barrier walls shall have the redundancy features of a drainage plane wall and shall not rely solely on the surface material or coatings, as well as sealant joints, to keep water at the exterior. Typical exterior materials include aluminum and glass curtain wall systems, ceramic tile, brick, precast concrete panels, concrete masonry units, composite metal panels, and cement plaster. Weather enclosure performance can be problematic with contemporary barrier walls designed with the exterior surface as the single water-resistant barrier, because of their reliance on superior construction craftsmanship to maintain a consistently watertight surface. Because the consequences of leakage through the exterior of court buildings are unacceptable, surface barrier walls shall be designed with a second line of protection against water penetration (i.e., sheet flashing or other weather-resistive barrier (WRB)) behind the surface material so that exterior walls of new court buildings are in effect designed as drainage plane or cavity wall systems, regardless of the primary exterior surface material.
- b. Drainage plane walls shall provide internal drainage by using separate surfaces, or planes, for water and environmental protection. The water-protection layer, made up of a WRB and flashings inside the wall behind the exterior finish, provides an initial weather protection barrier. These walls recognize the inevitability of water entry past the outermost exterior surface. Components of a drainage plane wall shall include:
 - Exterior veneer and seals, which shed most water and protect the WRB from sun and excessive water exposure.
 - Air space, which separates the inner and outer walls and provides a drainage pathway and drying of veneer anchors and weather barriers.
 - Sheet flashing or other WRB, which is a continuous membrane located behind the exterior surface veneer, with all joints and penetrations sealed against water infiltration. This membrane serves as the primary water-resistant weather line in a drainage plane wall system.
 - Flashings shall be located at all openings and wall penetrations that are transverse to the WRB, extend beyond the veneer, slope to drain, and pan up at inboard edges.

3.3 Exterior Cladding Systems

Life cycle cost analysis shall be used to determine the cladding system for the exterior façade of a courthouse building. Precast concrete panels and curtain walls are generally acceptable cladding systems for high-rise buildings. For low-rise structures, cement plaster and tilt-up concrete are acceptable construction systems. The system selection shall be predicated on maintainability, durability, and efficiency.

Careful attention shall be paid to the design of the cladding system when cement plaster is used. Cement plaster exterior walls shall function as modified drainage plane walls. Conventional exterior Portland cement-based plaster cladding is an allowable cladding system for a court building of one or two stories. Use of cement plaster cladding for buildings greater than two stories requires special considerations and Judicial Council approval.

A building clad with exterior plaster must be completely weather-resistive before the installation of cement plaster. Completely weather-resistive barriers include all surfaces that are to be covered by the plaster; all penetrations, such as windows and

doors; and all terminations, such as parapets and the base of walls. Two-layer WRB for exterior plaster cladding is required. The choice of WRB material will depend on project conditions, including sheathing material.

3.4 Flashing

Concealed flashing systems that cannot be easily replaced shall be durable and made of stainless steel, copper, or other metal not subject to corrosion. Flashing systems consistent in material, detail, scale, and quality with the facility design shall be provided. If flashings are exposed, they shall be designed using noncorrosive materials that are consistent with the design intent. Flashing systems should be removable when installed adjacent to other systems requiring periodic inspection and/or replacement (i.e., flashing systems adjacent to roofing terminations). Designers shall coordinate with manufacturers to ensure overall system performance.

3.5 Expansion Joints

Develop the structure to limit movement and suit the requirements for expansion joints. Expansion joints should be designed to allow for all anticipated building movement, plus a safety factor of 25 percent, without resulting in any damage to the joint. Where required, design the expansion joints to be minimally visible and watertight. Joint cover assemblies shall meet all code requirements for impact, loading, and fire protection.

3.6 Windows and Doors

- a. The best-proven institutional-grade window systems shall be provided. Glazed entry systems shall be constructed of finished aluminum or other metal systems. All glazing shall be insulated units for optimum thermal and acoustic performance, tinted or coated as required. Windows shall be fixed.
- b. Architectural metal and glass curtain walls are a special class of drainage plane wall, with pathways, flashings, and sealants internal to the framing elements. Architectural curtain walls may be designed as drainage plane walls, with internal seals, gutters, and drainage channels that function as the primary water penetration weather line. For this reason, the engineering, detailing, testing, and construction of glass and metal curtain walls for California court buildings shall follow the highest recommended industry practices.
- c. Public entrances require doors that are easy to operate and securely latch in a variety of environmental conditions. Balanced swinging doors, power-assisted swinging doors, or power-activated sliding doors are appropriate for courthouse public entries. Certain site environmental conditions may require vestibules to address site environmental conditions and to maintain interior comfort and cleanliness.
- d. Provide aluminum, stainless steel, or other approved metal institutional-grade door systems with matching frames for public entries. Painted aluminum frames and doors are not allowed for high-volume entrances. Provide flush panel metal doors with welded steel heavy-duty matching frames and institutional-quality hardware and finishes for service and staff doors and frames. Hardware on exterior doors shall be stainless steel.

3.7 Shading and Glare Control

Control glare and heat gain at all work areas and interior spaces. The glazing in the public lobby shall be mitigated for temperature and glare control so that security screeners and any other staff can work and see monitors in comfort, and security

**DIVISION TWO:
TECHNICAL CRITERIA**

11	ARCHITECTURAL CRITERIA
11.A	Objectives
11.B	Architectural Criteria
11.C	Building Elements: Exterior Construction
11.D	Building Elements: Interior Construction
11.E	Signage
12	Structural Criteria
13	Mechanical Criteria
14	Building Management System Criteria
15	Electrical Criteria
16	Lighting Criteria
17	Network and Communication Systems
18	Audiovisual Systems
19	Acoustical Criteria
20	Fire Protection Criteria

cameras can produce quality photographs. Consider exterior sunshades and window treatments to help mitigate the temperature and control glare.

3.8 Protection of Building Entrances

Protect building entries from exposure to weather. Provide exterior canopies, building recesses, or overhangs at all exterior entrances to protect doorways from exposure to rain and snow.

3.9 Exterior Stairs and Ramps

- a. Often the entry levels of court facilities are raised above street level and require universal access via permanent stairways and ramps serving all courthouse users. Provide a system of guardrails and handrails, as required by code, of stainless steel, bronze, or other permanent material that has a design and finish consistent with the facility design. Steel with epoxy finish coating can be used for guardrails and handrails not subject to high-volume use.
- b. Provide skate stoppers on ramps and benches to discourage skateboarding on the site. Identify exterior concrete items such as skate stoppers and shotcrete finishes, where appropriate, on the plans and specifications.

3.10 Walk-Off Mats and/or Grilles

Walk-off mat or grille systems are required to improve indoor air quality through the reduction of dirt and dust tracked into the building and of maintenance of indoor floor coverings. Provide a system of exterior and interior walk-off mats and/or grilles flush with the floor surface directly in front of the main entry doors and immediately after entering the public lobby. Mats shall be removable, cleanable, and replaceable. Grilles shall be constructed from corrosion-resistant durable materials, such as stainless steel, and the assemblies shall include a recessed catch basin with removable grilles to allow for cleaning of the catch basin. Minimum dimensions of walk-off mats and/or grilles shall be the width of the doorway and 10' total in length in the direction of travel, which can be split between the interior and exterior sides of the doors. The design should follow the American National Standards Institute / National Floor Safety Institute B101.6 Standard Guide for Commercial Entrance Matting in Reducing Slips, Trips and Falls.

3.11 Exterior Flagpoles

Provide two flagpoles, to accommodate a State of California flag and a U.S. flag, near the courthouse public entrance. One pole must provide for two flags to be flown at the same time (the Prisoner of War flag is required to be flown on certain dates).

So that the flag may be displayed at all times, it shall be properly illuminated during the hours of darkness. The design shall consider light pollution reduction strategies.

3.12 Dedication Plaque and/or Cornerstone

Provide a dedication plaque and/or cornerstone, with relevant project information and dates, that is permanently attached to the building. A cornerstone is appropriate for a prominent exterior location near the building entry, whereas a dedication plaque could be located either on the exterior or at a prominent interior location in the lobby or other public space.

4. Roofs

4.1 Low-Slope Roofing System

- a. The roof shall be weathertight and provided with a positive drainage that will effectively dispose of rainwater. The roof shall be insulated so that the heat transfer values from roof to occupied area comply with the California Building Code. Low-sloped roofs shall provide a minimum slope in accordance with the manufacturer's warranty for the specified roof system, but a slope of 1/4" per foot measured along the valleys is the minimum required slope to drain. Roof drainage slopes may be achieved by the elevations of the roof structure or with built-up fill material under the membrane.
- b. The type of warranty coverage must be determined during the initial contract negotiation due to the cost and construction impact that may result from high prevalent wind speeds. The type of warranty shall cover a high quality of continuous-membrane roofing and flashing system with compatible components that will not permit the passage of liquid and will withstand—without failure—wind loads, building movement, flotation loads, thermally induced movement, and exposure to weather. The selected roofing system should have an ASTM E108 and a manufacturer's warranty for a minimum period of 30 years. Fully adhered ASTM D6754-10 single-ply roofing is an acceptable system for low-slope roofs.
- c. The roof membrane will be replaced occasionally over the lifespan of the building. To facilitate reroofing, relatively large uninterrupted roof planes are preferred. Flashing assemblies at curbs and roofing terminations should be removable and reinstallable (i.e., a two-part system with removable reglet and counterflashing) to maintain the integrity of the overall building envelope weather line after a roofing replacement. Mechanical and electrical rooftop equipment and rooftop screens shall be designed to permit reroofing in the future. Curbs and equipment bases on roofs shall be a minimum of 8" high to allow adequate space for roof membrane terminations and flashing systems.
- d. Extreme low-odor, low volatile organic compound, fluid-applied systems are encouraged for roof upgrades on existing facilities. A 20-year warranty is required for whichever system is chosen. If restoration is not possible, default to roof replacement. Fully adhered ASTM D6754 single-ply roofing is an acceptable system, in addition to the other types of thermoplastic single-ply roofing permitted by California Building Code section 1507.12.
- e. Roof drains shall be recessed below the roof level to form a collection basin; roof drain bodies shall be a two-part cast iron type that allows the waterproof membrane to be clamped between drain body parts so that water infiltrating the roofing layers can drain into the system.
- f. Provide additional protection at walking surfaces for rooftop service routes.

4.2 Rooftop Equipment

Rooftop equipment shall be kept to a minimum. Locate equipment in rooftop penthouses (preferred) or behind visual screens. Integrate the location, size, and finish of rooftop penthouses and visual screens with the architectural design. Install critical rooftop equipment to permit roof system replacement without unreasonable disruption of equipment operation. Satellite antennae and telecom equipment shall be located on the roof, and a point of entry into the building and a distribution pathway to a central intermediate distribution frame shall be considered when

DIVISION TWO: TECHNICAL CRITERIA

11 ARCHITECTURAL CRITERIA

11.A Objectives

11.B Architectural Criteria

11.C Building Elements:
Exterior Construction

11.D Building Elements:
Interior Construction

11.E Signage

12 Structural Criteria

13 Mechanical Criteria

14 Building Management
System Criteria

15 Electrical Criteria

16 Lighting Criteria

17 Network and
Communication Systems

18 Audiovisual Systems

19 Acoustical Criteria

20 Fire Protection Criteria

Balance the need for security with the need for openness, transparency, and natural light.

Provide a quality work environment that is conducive to and suitable for performing the required tasks of the building occupants.

establishing a roof location for this equipment. Refer to chapter 15, Electrical Criteria, for additional requirements.

4.3 Roof Access

Provide an interior permanent dedicated industrial stair (not a ship's ladder) and access hatches to the roof of all court facilities with a roof slope of less than 3:12. This stairway can be an extension of the building exit stair system. Provide access to the roof via the freight elevator, if the roof includes significant mechanical equipment that requires regular maintenance or the transport of heavy replacement parts. Maintenance worker safety shall be a prime design consideration in the development of roof access and roof parapets. The rooftop access shall be of sufficient size to allow the transport of required tools, small equipment, and materials. Rooftop access shall be drawn early in design for early installation.

5. Building Maintenance

All roofs that will have regular maintenance, or on which exterior maintenance equipment will operate, shall have around the entire perimeter parapets or guardrails that comply with the building code.

All elevated areas without parapets or guardrails shall have safety anchorages (a secure point of attachment that complies with the California Building Code, for lifelines, lanyards, or other fall-protection deceleration devices) within 6' of the edge. Exterior balconies are not permitted.

Roofs with a slope greater than 3:12 shall have safety anchorage integrated into adjacent eaves or gable end walls to facilitate maintenance work.

5.1 Window Washing and Façade Access Equipment

- a. Design the building exterior to accommodate safe and cost-effective exterior maintenance procedures. Building maintenance operations include, but are not limited to, window cleaning, caulking, metal polishing, reglazing, and general maintenance on building surfaces. Buildings exceeding 130 feet in height are required by code to have an in-place window washing system permanently mounted on the building. Shorter buildings may have other options available for providing façade access from the ground. Both operational and equipment costs shall be considered in determining the most cost-effective system in accordance with the building's design and the frequency of the exterior maintenance schedule.
- b. Provide features necessary for maintenance-worker safety in accordance with occupational safety codes and regulations. Where necessary, provide required davits and sockets, tie-offs, guardrails, and relocatable, motorized platforms to reach the exterior on all building elevations. Provide a clear path around the base of the building at the ground level for ground-rigged maintenance platforms that need to be rigged to or transferred between the roof-mounted davits. For low-rise buildings, provide a clear path at ground level for motorized articulated lifts to reach all exterior windows. California regulations applicable to façade access equipment can be found in California Code of Regulations, title 8, article 5 (Window Cleaning), section 3281 et seq., and article 6 (Powered Platforms and Equipment for Building Maintenance), section 3292 et seq.

5.2 Bird Roosting and Nesting Control

Design exterior façades and roof overhangs to inhibit bird roosting and nesting. Provide means of preventing bird roosting or nesting on horizontal surfaces greater

than 6" deep, especially in protected or covered areas. The design shall inhibit bird species known to nest in the underside of overhangs and soffits. Consider sloped surfaces to deter birds perching.

11.D BUILDING ELEMENTS: INTERIOR CONSTRUCTION

1. Interior Building

1.1 Daylighting

Provide natural light to all primary public waiting areas and the main lobby. Plan and design interior spaces to allow glare-free natural light at work areas wherever possible. Develop methods to share glare-free natural light through the use of interior glazing, sidelights, borrowed light, and light wells. Consider the solar orientation of the building, and provide methods of shading and glare control on façades with excessive solar exposure. In areas of excessive solar exposure that will not be mitigated by shading and glare control on the façade, provide window coverings. See 11.D.1.13 for window covering requirements.

1.2 Workplace Environment

Standards for lighting, acoustics, heating, ventilation, air-conditioning, and other building systems shall be applied to enhance the work environment and to support a sustainable design objective. Design spaces to reduce energy and materials consumption.

1.3 Floor-to-Floor Heights

The standard floor-to-floor, or slab-to-slab, dimension for multistory courthouses shall be 14' to 16'. Refer to 2.C, Area and Volume Definitions, for requirements for relative building volume.

1.4 Plenum Spaces

- a. Provide space above all finished ceiling areas for the heating, ventilation, and air-conditioning (HVAC) supply and return distribution; electrical distribution; mechanical equipment; fire sprinkler systems; voice, data, and low-voltage cables; and other devices. Size plenum spaces to allow for future modification of these systems.
- b. Coordinate the size, access, and clearance requirements of systems located in plenum spaces with the depth of structural elements to allow required clearances for all systems to all parts of the building.
- c. Provide access to all plenum spaces for servicing all components. Provide access to plenum spaces above courtrooms for maintenance of utilities and modification of cabling and outlets, which serve the floor above.

1.5 Interior Partitions

- a. The minimum standard for steel studs in multilayered gypsum wallboard assemblies is 20 gauge, unless a lighter gauge is required for acoustical reasons.
- b. Comply with the manufacturer's recommended criteria for deflection and span with interior pressure loading based on tested industry standards.
- c. Provide fire- and smoke-rated interior partitions, where required, in accordance with accepted industry-standard tested assemblies and approved manufacturers' designs for assemblies satisfying the test criteria.
- d. Provide a system of concealed, permanent, secure, and appropriately designed backing, supports, and anchorages for all handrails, wall-hung cabinets, court

DIVISION TWO: TECHNICAL CRITERIA

11 ARCHITECTURAL CRITERIA

11.A Objectives

11.B Architectural Criteria

11.C Building Elements:
Exterior Construction

11.D Building Elements:
Interior Construction

11.E Signage

12 Structural Criteria

13 Mechanical Criteria

14 Building Management
System Criteria

15 Electrical Criteria

16 Lighting Criteria

17 Network and
Communication Systems

18 Audiovisual Systems

19 Acoustical Criteria

20 Fire Protection Criteria

Integrated Interior Design

The design professional shall select the size, color, style, and finishes of movable furniture and equipment and integrate and coordinate them with the other interior elements.

seals, and other surface-mounted fixtures, equipment, systems, and building specialties.

- e. Provide corner guards, where required.
- f. Refer to chapter 19, Acoustical Criteria, for additional partition requirements.

1.6 Ceilings

- a. Ceilings shall be designed for optimal visual, lighting, and acoustic performance. Refer to chapters 16, Lighting Criteria, and 19, Acoustical Criteria.
- b. Custom ceilings are not permitted. Ceilings throughout the courthouse shall be specified off-the-shelf for easy replacement and maintenance.
- c. Integrate required technical features with the use of ceiling soffits, coffers, and materials to accommodate acoustic materials, lighting, sprinklers, speakers, cameras, projectors, and projection screens.
- d. Design ceilings of chambers, offices, and conference rooms to integrate acoustic panels, lighting, and HVAC supply and return grilles.
- e. Ceiling panels shall have a positive connection that engages the wood panel to the metal framing of the soffit. Screw connections shall be installed through the panel from below. Aluminum Z strips supported by wood, plastic shims providing spacing, and adhesive glue may be used in addition to mechanical fasteners, but not by themselves, for adequate structural connection to the panel.

1.7 Public and Private Toilet Rooms

- a. Public toilet rooms are heavily used and require durable, washable, and easily maintained materials and finishes. To avoid flooding, all toilet rooms should have floors sloped to a drain with primer. Minimum finishes and features include:
 - Coved ceramic tile floors;
 - Glazed ceramic tile wall surfaces up to a minimum 4' wainscot height (consider full-height tile on walls);
 - Solid-surface countertops;
 - Undercounter-mounted lavatories;
 - Stainless steel or monolithic plastic floor-mounted and braced institutional-quality toilet stall dividers and doors, and wall-hung urinal screens;
 - Institutional-quality toilet fixtures and stainless steel toilet accessories;
 - Wall-mounted mirrors behind the lavatory tops;
 - A diaper-changing table in each restroom; and
 - Semigloss-painted washable wall and ceiling surfaces.

Solid surface is an acceptable finish for countertops, but materials requiring a multitude of joints (e.g., ceramic tile) are not, because of the ongoing maintenance implications of cleaning surfaces with joints. Dark-colored grout and caulking shall be used for ceramic tile floors and walls, for maintainability.

- b. Avoid combo units for the toilet seat cover, tissue, and receptacle because they may affect the Americans with Disabilities Act (ADA) required grab bar

clearance. Provide toilet accessories in a noncorrosive, durable material (such as stainless steel) that are readily serviceable and consistent with the building design.

- c. For high-volume public restroom entries, consider the use of doorless vestibules with integrated sound and visual screening.
- d. Provide one shower and changing area (for each gender) in a staff toilet room off the private corridor on the first floor or lower level of the building. The dressing area shall have wall-mounted hooks.

1.8 Elevators

- a. Vertical transportation strategy depends on project requirements and design parameters. If the project contains more than one floor or level change, the building shall include vertical conveyance systems. Courthouses typically require three elevator systems: public, private (staff), and detention (in-custody defendants). Staff elevators shall have an average interval of less than 30 seconds (wait time of 18–20 seconds), public elevators shall have an average interval of less than 40 seconds (wait time of 24–26 seconds), and both elevator groups shall have a handling capacity of 15 percent of the building population to be served. All passenger elevators must meet the design requirements of the building code for access by persons with disabilities and emergency personnel. If high-volume areas are located at any other level than the first, provide extra capacity to move large numbers of people to and from that level.
- b. If the project contains more than one floor or level change, a shared or dedicated elevator for staff, freight, and service is required for deliveries, staff vertical movement, trash transport, document transport, and building maintenance. Staff elevators can double as a freight or service elevator in smaller courthouses, but in larger court buildings, a dedicated service elevator is preferred, with its own vestibule on every floor. Provide at least one public and one staff building elevator large enough to accommodate a paramedic’s stretcher; this may be the service elevator, in buildings with a dedicated service elevator. Use of an elevator for paramedic stretcher may be accomplished by changing the door mechanism of a regular elevator to open to one side instead of opening from the middle. Elevators for in-custody defendants may require an independent control system if their operation is remotely controlled from the central holding control room.
- c. Hydraulic elevators are permitted for two- or three-story facilities, but traction elevators are preferred. Facilities that are four stories or taller shall have traction elevators.
- d. Braille lettering and audio signals shall be provided at elevators and where required by code. Passenger elevator car interiors shall have durable and vandal-resistant finish materials consistent with the building design. Cab wall and ceiling panels shall be replaceable. One cab in the building shall have the capacity to accommodate extra-long deliveries such as rolls of carpet; this may be the service elevator cab. A typical car interior ceiling height is 9’ to 10’.
- e. The following criteria shall be met by the design firm:
 - Confirm if 1” mesh and ladders are required in elevator pits.
 - Confirm if separation is required for in-custody elevators.

DIVISION TWO: TECHNICAL CRITERIA

11 ARCHITECTURAL CRITERIA

- 11.A Objectives
- 11.B Architectural Criteria
- 11.C Building Elements:
Exterior Construction
- 11.D Building Elements:
Interior Construction
- 11.E Signage
- 12 Structural Criteria
- 13 Mechanical Criteria
- 14 Building Management
System Criteria
- 15 Electrical Criteria
- 16 Lighting Criteria
- 17 Network and
Communication Systems
- 18 Audiovisual Systems
- 19 Acoustical Criteria
- 20 Fire Protection Criteria

- Coordinate duress button with judges' elevators during design and construction.
- Do not run any foreign services (that do not serve the elevators) through the elevator machine room.
- Coordinate card access with elevator stops and interior, and define function and operation.

1.9 Stairs

- Provide convenient stairs that encourage walking to other floors in support of the sustainable design objective by reducing demand on the elevator systems. Communicating stairs can be provided in both the public areas and the private circulation system.
- Required exit stairs may be designed to encourage use by staff for normal circulation unless restricted by the California Building Code, with materials and finishes similar to those in the private corridors and introduction of natural lighting, when appropriate.
- Provide a public connecting stair to access high-volume public uses (such as public counters and self-help center) on the second and third floors of courthouses, in addition to elevator access. Design and finish open stairways that connect public lobbies to the upper floors in harmony with materials used in the public lobby. Preengineered steel stair and railing systems are acceptable for exit and communicating stairs but not for high-volume public stairs. Stair treads and intermediate landings shall either be pan-type and filled with concrete or terrazzo or have dimensional stone paving; channel or flat-plate stair stringers are acceptable. Provide architectural railings for communicating stairs; a manufacturer's standard railing system might be adaptable for this purpose.

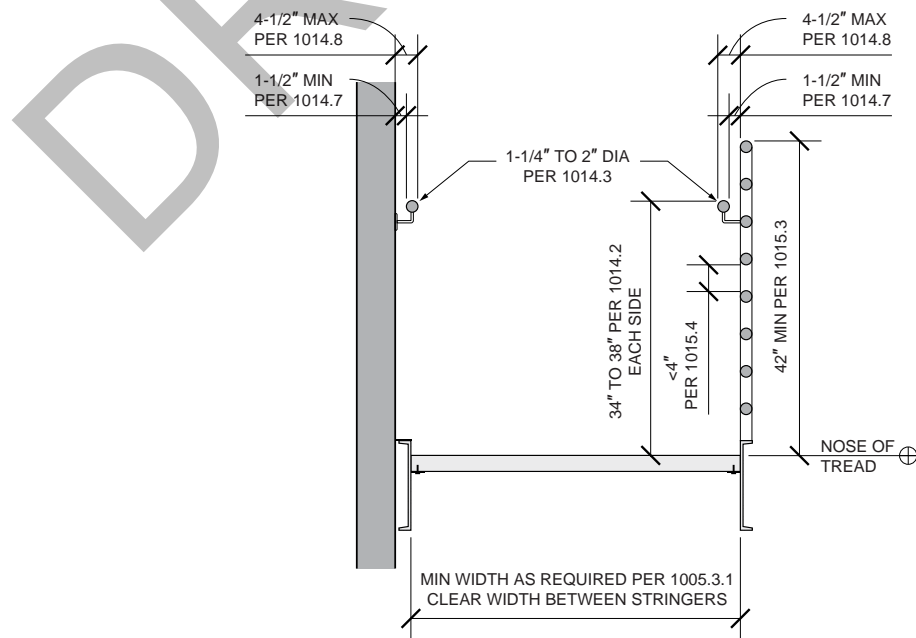

DIA = diameter.
 Note: Code citations refer to sections of chapter 10 of the California Building Code.

Figure 11.1 Egress Width Measurement Method

- d. All staircases shall meet the California Building Code requirements. The required egress width for stairways shall be measured as shown in figure 11.1.

1.10 Doors Frames and Hardware

- a. Provide one-piece, welded steel door frames at permanent locations requiring oversized or heavy doors or having significant traffic, including courtrooms.
- b. Provide prefinished aluminum door frames in partitions subject to periodic remodeling. Tempered glass, full-height, 12" to 18" wide sidelights or glazed doors may be provided at private offices and conference rooms, except in judicial chambers, jury deliberation rooms, and offices that require privacy.
- c. Provide flush solid core doors for typical interior conditions, where allowed by fire codes. Door construction shall meet or exceed Architectural Woodwork Institute (AWI) premium grade for courtrooms; custom grade for chambers, courtroom entrances, and private offices; and paint grade for all other doors. Courtroom public entrances may have stile and rail doors with glass vision panels. Courtroom entry doors may have vision panels allowing a view into the courtroom, but the courtroom vestibule doors off the public corridor should be solid.
- d. All hardware provided shall be institutional grade. Pins and hinges on all doors located on corridors, lobbies, and other public spaces shall be installed on the secure side of the door or shall be fixed. Latches and locksets shall be full mortised type; locks shall have removable key cylinders. Locks shall be grand-mastered and master-keyed. Provide multiple keys for every lock type. Certain locks off-master shall be specified. Hardware specified for courtroom use shall be of the highest quality and shall be selected for quiet, acoustically optimal operation. Selected doors require electric locksets or strikes and proximity-reader card-key locking systems. Provide heavy-duty institutional-grade door closers in public areas, especially in high-traffic areas.

1.11 Courtroom Platforms

Raised platforms in courtrooms shall be of a construction method that does not require underfloor fire sprinklers. Handrails, if required at stairs and/or ramps, shall be discreet and integrated into courtroom design.

1.12 Flooring

- a. Subfloors: New and existing concrete subfloors must meet the requirements of ASTM F710, Standard Practice for Preparing Concrete Floors to Receive Resilient Flooring.
- b. Carpet: Consistent with the expected functional lifetime, select carpet that is durable and low maintenance. Carpet must be eligible for recycling by the supplying mill or fiber producer to an existing operational third-party certified recycling center. Specify carpet appropriate to the traffic expected in the space. Broadloom carpet is not permitted. Carpet tiles should be a minimum standard size of 24" square and a maximum of 36" square.

The minimum specification basis of carpet and carpet tile design is as follows:

- Fiber/Yarn: 100 percent Antron Lumena solution-dyed type 6,6 nylon.
- Construction: Tufted, level or multilevel loop pile, cut and loop, or tip shear, as long as product passes minimum Texture Appearance Retention Rating (TARR) of 4 out of 5 on the TARR scale.
- Pile Weight: Minimum 16 ounces per square yard.

**DIVISION TWO:
TECHNICAL CRITERIA**

11	ARCHITECTURAL CRITERIA
11.A	Objectives
11.B	Architectural Criteria
11.C	Building Elements: Exterior Construction
11.D	Building Elements: Interior Construction
11.E	Signage
12	Structural Criteria
13	Mechanical Criteria
14	Building Management System Criteria
15	Electrical Criteria
16	Lighting Criteria
17	Network and Communication Systems
18	Audiovisual Systems
19	Acoustical Criteria
20	Fire Protection Criteria

If ambient noise is a concern, consider a cushion-backed carpet tile. When higher acoustical values are required in a space, specify carpet that will adequately perform a dual role of a floor covering and a versatile acoustic aid. Products must meet the Carpet and Rug Institute standards for indoor air quality. Carpet on ramps or courtroom platforms shall meet wheelchair access requirements.

- c. **Impervious Flooring:** Public corridors and lobbies that carry significant foot traffic and provide major circulation pathways throughout the building shall have extremely durable, slip-resistant materials that require low maintenance. Life cycle cost analysis shall be used to determine material options, such as terrazzo and manufactured tile.
- d. Horizontal embedded conduits in slabs on metal deck are not permitted.
- e. Hydronic mechanical rooms shall not be located over water-damage-sensitive areas such as intermediate distribution frame (IDF) or main distribution frame (MDF) rooms. If it is unavoidable:
 - Make the floor and base cove and all penetrations through them watertight.
 - Add floor drains to prevent any significant water depth.
 - Prevent any pooling of water on the floor.

1.13 Window Coverings

- a. Provide window coverings appropriate for visual screening and glare control in work areas and courtrooms. Courtrooms with skylights, windows, or borrowed light require window coverings to prevent glare and visual distractions and to allow light control during audiovisual presentations.
- b. Consider the method of operation for window coverings in terms of its appropriateness for the function of a space. Manually operated shades may be provided for private offices and open office work areas, but not public corridors and lobbies. In public areas, motorized shades are permitted. Synchronized, motorized shades are not permitted. The controls for the shades shall be at ADA-accessible height and secured such that only authorized personnel may operate them.
- c. Consider the exterior image of the building when selecting the color and materials of window coverings, to provide an image consistent with interior and exterior design intent.

2. Modular Furniture and Workstations

Modular systems furniture (MSF) is composed of freestanding partition panels, worktops, files, components, and integrated circuitry and access raceways for provision of electrical power, voice, and data cabling. The building shall be designed to allow for flexible rearrangement of MSF and connection to building systems. The electrical, telecommunications, and data systems and the capacities must be designed to ensure compatibility with MSF design requirements.

2.1 High-Density Files

Where required, provide a mobile high-density filing system. Locate the system on the ground floor or an adequately reinforced floor structure, near the public office clerk's counter. Coordinate high-density filing systems with building structure for distribution of gravity loads and seismic bracing requirements as a function of the height and configuration of the system. Specify fixed rows for every six movable

rows or as determined by the Judicial Council to allow access to multiple rows of files. Provide a locking feature for confidential files. Specify seven-shelf-high cars. The filing system shall be accessible to persons with disabilities and shall be coordinated with structural slab depressions so that the base of the filing system is flush with adjacent finished floor elevation. Use of a motorized system may be acceptable for infrequently accessed files.

2.2 State Seal

Provide the official seal of the State of California in each courtroom, in metal or composite material, with a minimum size of 32" in diameter. Choose the material to avoid glare on the seal. The appearance and location must reflect the dignity of the court.

2.3 Flagpoles

Provide two flagpoles and holders in each courtroom, to accommodate a State of California flag and a U.S. flag. Flagpoles may be wall or floor mounted. Their location shall not interfere with bench accessibility.

3. Interior Finishes and Materials

The *Facilities Standards* specifies four levels of interior architectural finishes corresponding to a component’s target functional lifetime, required use, architectural importance, durability requirements, and surrounding interior context. Brief descriptions of example interior finish levels are provided below for reference; however, the designers shall propose finishes for each project. See table 11.1 for suggested finishes for the four levels.

- Level I Interior Finishes: Specified for building components with long functional lifetimes and high aesthetic importance. Level I finishes have quality, long-term durability; ease of maintenance and cleanliness; and ability to sustain aesthetic appeal over a long period.
- Level II Interior Finishes: Specified for high-volume public service areas with midrange functional lifetimes and increased architectural importance. Level II finishes offer midrange durability, yet require regular maintenance and refurbishment, such as occasional repainting.
- Level III Interior Finishes: Specified for building components with midrange functional lifetimes and moderate architectural importance. These finishes require regular repair, maintenance, and refurbishment, such as repainting.
- Level IV Finishes: Specified for building components that may have long functional lifetimes. These are typically utility or support areas that have relatively low architectural importance. Level IV finishes are durable and maintainable.

4. Architectural Woodwork for Courtrooms

4.1 Veneer Panels and Casework

- a. Provide hardwood veneer panels with solid hardwood trim and edge banding, with shop-applied stain, and finish with three coats of transparent sealer per AWI premium-grade requirements. Wood from a certified sustainable source is preferred. A solid wood base to match courtroom panels or a metal base may be used in public spaces and chambers.
- b. Courtroom built-in components may include the judge’s bench; courtroom clerk’s, court reporter’s, and court security officer’s stations; jury box; public bench seating; counsel tables, rails, and gates; and an accessible lectern. (Note that the bench seating, counsel tables, and lectern may be standard modular

**DIVISION TWO:
TECHNICAL CRITERIA**

**11 ARCHITECTURAL
CRITERIA**

- 11.A Objectives
- 11.B Architectural Criteria
- 11.C Building Elements:
Exterior Construction
- 11.D Building Elements:
Interior Construction
- 11.E Signage

- 12 Structural Criteria
- 13 Mechanical Criteria
- 14 Building Management
System Criteria
- 15 Electrical Criteria
- 16 Lighting Criteria
- 17 Network and
Communication Systems
- 18 Audiovisual Systems
- 19 Acoustical Criteria
- 20 Fire Protection Criteria

Table 11.1 Notes

* Arraignment courts may have a combination of carpet and hard surface flooring. Hard surface flooring might be appropriate under spectator bench seating.

† Painting and gypsum board are appropriate above the wainscot level in corridors and in combination with other materials in courtrooms. Painted gypsum board is standard above tile in toilet room walls.

Signage

Grouping too many signs in one place (e.g., at entries, in lobbies, and in corridors) is unsightly, may confuse first-time visitors, and may decrease the dignity of the facility.

Maintain brief, clear, and polite messages in signage.

Table 11.1 Finish Matrix

	FLOOR						WALLS						CEILING				METAL		
	Premium Carpet	Manufactured Tile or Terrazzo	Midgrade Carpet	Ceramic Tile	Vinyl Composition Tile (VCT)/ Linoleum	Sealed Concrete	Paneling (Wood Veneer)	Premium Acoustic Wall Panels	Ceramic Tile	Painted Gypsum Board	Premium Base (Metal)	Rubber Base	Architectural Soffits	Premium Acoustic Panels	Midgrade Acoustic Panels	Painted Gypsum Board	Exposed Structure	Premium Clear-Coated Metal	Painted Metal or Stainless Steel
Level I																			
Courtroom* †	•	•	•				•	•	•	•	•		•	•			•	•	
Public Lobby	•	•					•	•		•	•		•	•	•	•		•	•
Public Corridor	•	•	•	•	•		•		•	•			•	•	•	•		•	•
Public Restroom†				•					•	•	•	•				•			•
Level II																			
Jury Assembly Room			•							•	•	•	•	•	•	•			•
Clerk's Public Counter		•	•							•		•	•	•	•				•
Self-Help Center		•	•							•		•	•	•	•				•
Child Waiting Area			•	•	•					•	•	•	•	•	•				•
Level III																			
Judicial Officer Private Office	•	•								•	•		•	•					•
Staff Office/Workstation			•							•	•				•				•
Jury Deliberation Room			•							•	•				•				•
Conference Room			•							•	•	•	•						•
Employee Breakroom					•					•	•				•				•
Staff Toilet				•	•					•	•				•				•
Restricted Corridor			•							•	•				•				•
Restricted Communicating Stair			•	•	•	•				•	•					•			•
Copy Room					•					•	•				•				•
Level IV																			
Loading Dock						•						•						•	
Emergency Egress Stair						•						•						•	
Mechanical Rooms						•						•						•	
Telecom Equipment Room						•						•						•	
Storage					•	•				•	•					•		•	
Janitor Closets					•	•						•						•	

furniture customized to match the courtroom finish.) Modular furniture with a built-in pony wall may be permitted at the discretion of the Judicial Council.

- c. All courtroom desktop work surfaces, whether modular or custom-built, shall be wood or solid surface.
- d. All veneer panels shall be positively attached to supporting elements. Adhesives or frictional resistance due to the effect of gravity are not considered positive attachments.

4.2 Cabinets and Casework

Provide (at a minimum) AWI premium-grade plastic laminate casework with ADA-compliant base cabinets and plastic laminate tops.

11.E SIGNAGE

Clear, legible, and strategically placed graphics and signage are essential design elements for a court facility. Signage directs visitors and staff to where they need to go and contributes to a positive experience in the courthouse by orienting users and minimizing confusion. Signage is particularly important in courthouses that house multiple court functions or a high volume of court users.

1. General Requirements

- a. An integrated, complementary, and comprehensive signage program shall address both code-required signage (such as exit signs, exiting plans, and room numbers) and non-code-required signage (building directories, notices). The graphics and signage programs shall be developed during early design stages to integrate signage with the design concept, functional program, and building circulation zones. Attractive, legible signs showing directions and information shall be incorporated into the design of all public areas. Locations for uniform static and dynamic signage should be considered in the early design stages and based on precedents such as completed, well-functioning court projects. Additionally, electronic displays of graphical information—especially information that changes frequently—offer an orderly and flexible solution for the changing needs of certain spaces.
- b. All signage must meet the requirements of the Americans with Disabilities Act and the most recently adopted provisions of the California Building Code regarding accessibility. As appropriate for community needs, courthouse signage should be accessible in English and in other common languages (e.g., Spanish) to direct persons who come to court and are limited English proficient (LEP). The Judicial Council requires various wayfinding strategies for both static and electronic signage to assist LEP users. Employ National Center for State Courts requirements and best practices from around the state in courthouse design and in the use of signage and wayfinding strategies to enhance access for LEP court users. Incorporate language access considerations in courthouse design and the use of technology to augment the court’s ability to provide information in multiple languages. An ongoing language access signage and technology grant program is available to trial courts that are interested in obtaining funding to support their courthouse signage and/or technology initiatives.
- c. Ideally, signs should use pictograms to establish consistency across all courts. English should be used for basic information and instructions and prominent multilingual posting of public notices and informational court materials. A discussion should take place early on with the court and the Judicial Council team to determine if multilingual signs are appropriate.

**DIVISION TWO:
TECHNICAL CRITERIA**

11	ARCHITECTURAL CRITERIA
11.A	Objectives
11.B	Architectural Criteria
11.C	Building Elements: Exterior Construction
11.D	Building Elements: Interior Construction
11.E	Signage
12	Structural Criteria
13	Mechanical Criteria
14	Building Management System Criteria
15	Electrical Criteria
16	Lighting Criteria
17	Network and Communication Systems
18	Audiovisual Systems
19	Acoustical Criteria
20	Fire Protection Criteria

- d. All signage shall be designed and placed to discourage vandalism and thievery. Signs shall not be easily removable in public areas.
- e. Number rooms logically and consecutively to enable court users, including visually impaired persons, to make assumptions about where their destination is located. Public room numbers shall be sequential and predictable. Base courtroom labels on a predictable sequence, not the internal administrative department labels. For example, a second-floor courtroom shall be labeled Courtroom 200 or Room 200, not Division 200 or Department 4. Room numbering from floor to floor shall be consistent. Assign room numbers early in design and obtain the court's approval.
- f. Position room label signage at doorways, where court users, including sight-impaired persons, expect to find information. Locate signage of building management rooms, which are not accessible to the public, in different areas than accessibility signage. For example, locate electrical closet room numbers above the door, rather than to the side.

2. Signage Specifics

The following guidelines shall apply to signage and graphics in various locations within the building.

2.1 Building Entry

- a. Clearly mark the courthouse entrance with signs indicating that all persons and articles entering the facility are subject to search, that no weapons of any kind are allowed within the facility or on the grounds of the facility, and that violators are subject to fine and arrest.
- b. Restrict all other signage at entry to preserve a unified and attractive façade.
- c. The signs at entry must include the State of California seal, court name, address, accessible symbol, and hours of operation. If some functions, such as traffic payment windows, are located before the screening area, provide directional signage.
- d. The dedication plaque shall match the style of the other signs at the building entry.
- e. Maintain legibility of signs containing letters during the day and nighttime. Take into account any shadow patterns with changing light conditions.

2.2 Building Directory

Locate a building directory near the main public entrance. The directory shall contain a diagram listing all major building components. This directory shall be located in an area seen by the public after they have been screened and may be integrated into an information desk. Provide smaller directories at each elevator lobby with information about various occupancies on that floor. Provide a directory before security screening if there are functions located outside the screening area.

2.3 Court Calendar Postings

Provide digital monitors to display the court calendar in the public lobby after screening. Calendar information may also be displayed at courtroom entries. This display shall be uniform in appearance; postings shall be limited to the display area. Electronic calendars should be standard practice at entries and courtrooms.

2.4 Public Notice Boards

A consistent, controlled system of wall-mounted notice boards shall be used throughout the facility to allow public postings. All computer-generated signs, handwritten signs, and notices will be restricted to these areas. Provide public

notice boards in consistent public locations to prevent staff from taping signs to walls. Design of these places for temporary information should be integrated architecturally with the overall interior space.

2.5 Courtroom Entry Signage

All signs outside courtroom doors shall be of uniform appearance and integrated with calendar information displays. The courtroom numbering system may be displayed at the top or side of the entry door and in the largest font size possible. ADA requirements shall also be met. Architects and engineers shall consider displaying the names of the judges as part of the electronic display. All other signage will be posted in the electronic display below the judge’s name, according to the needs of the court. Consideration should be given to creating a display panel that will allow paper inserts—easily printed by the court. No signage shall appear on courtroom doors. The designer shall work with court representatives to minimize signage.

Examples of court-specific entry signage (which could be displayed electronically) include the following:

- “Calendar Postings”
- “Jurors and Witnesses Please Remain in Hallway Until Called”
- “Before Entering With Children, Please See Court Staff”
- “Closed Hearing”
- “No Cell Phones or Beepers, Please”

2.6 Courtroom Signage

Provide a consistent, controlled signage system within the courtroom to prevent individual postings by court personnel. The courtroom shall include the State of California seal, not the county seal, behind the judge’s bench.

Examples of court-specific signage include the following:

- “No Communication With Inmates” (posted on the dock inside the courtroom facing the audience or in an area seen by the public after they are in audience seating)
- Jury seat numbering
- Courtroom conduct
- Typical questions for jurors

The Judicial Council’s *Courthouse Naming Policy* (eff. May 11, 2009; rev. July 21, 2023) affects signage, including naming of court buildings. Regardless of whether an individual’s name is used, the building identification sign shall include “Superior Court of California, County of [county].” The dedication plaque shall be added to the building after construction completion. The year and date of dedication shall not be placed in the building signage in advance.

2.7 Other Signage Considerations

- a. Provide a consistent, controlled system of other signs, such as restricted access warnings, directional signs, signs designating services for persons with disabilities, and procedural guides. If high-volume functions, such as the jury assembly room and the public counter, are not immediately visible from the entry lobby, clearly displayed graphics shall be prominently displayed to guide users to these areas.

DIVISION TWO: TECHNICAL CRITERIA

11 ARCHITECTURAL CRITERIA

- 11.A Objectives
- 11.B Architectural Criteria
- 11.C Building Elements: Exterior Construction
- 11.D Building Elements: Interior Construction
- 11.E Signage

- 12 Structural Criteria
- 13 Mechanical Criteria
- 14 Building Management System Criteria
- 15 Electrical Criteria
- 16 Lighting Criteria
- 17 Network and Communication Systems
- 18 Audiovisual Systems
- 19 Acoustical Criteria
- 20 Fire Protection Criteria

- b. Visible “No Smoking” signs must be provided to alert the public not to smoke within 20’ of an entrance.
- c. Wayfinding directional signs shall be installed in the stairwells.
- d. Any photographs or artwork displays in the courthouse shall meet all the copyright law requirements.

DRAFT

DIVISION TWO: TECHNICAL CRITERIA

12

STRUCTURAL CRITERIA

SECTION	TOPIC	PAGE
12.A	Objectives	12.2
12.B	Structural Systems	12.2
12.C	Criteria for Service Loads	12.2
12.D	Criteria for Rare Loads	12.4
12.E	Life Cycle Cost Analysis	12.6
12.F	Quality Assurance	12.7
12.G	Fire-Resistive Ratings of Structural Elements	12.7



Family Justice Center Courthouse, County of Santa Clara
San Jose, CA
Zimmer Gunsul Frasca LLP

Structural design goals for new trial court facilities shall reflect functional and programmatic needs, adaptability for future technology, and the ability to withstand potential damage and to minimize impact on disruption of building services and operations from disasters and rare events.

The Judicial Council shall determine the regional importance and any performance objectives above code expectations for all new facilities.

This chapter describes general and technical criteria for structural systems in new Judicial Council buildings.

12.A OBJECTIVES

1. Strength and Serviceability

The structure shall have the strength to support the intended occupancies, including level floors of adequate flatness, stiffness, and vibration control from environmental and internal sources.

2. Adaptability

The structure shall be adaptable to changes of use and occupancy, allowing for the installation of new information technology or mechanical, electrical, and plumbing systems resulting from changing technology. Adaptability features include gravity systems that have capacity to accommodate most nonspecialized courthouse occupancies, that enable local strengthening, and that facilitate additional floor and wall penetrations.

3. Performance in Rare Events

Most Judicial Council facilities incorporate specialized features that will not allow relocation to alternative spaces without considerable preparation and alteration. Therefore, it is important to estimate the nature of damage that could be caused by rare but possible events such as high wind, fire, extreme snow and rain, flood, and seismic activity, and the possibility the building will not be available for reoccupancy for an extended length of time.

Except as noted below, the “A” chapter amendments to the California Building Code by the Division of the State Architect—Structural Safety (DSA-SS) and the Department of Healthcare Access and Information (HCAI) do not apply to Judicial Council projects.

4. Prefabrication and Modular Technologies

Consider prioritizing prefabrication of structural elements and use of modular techniques to accelerate construction timelines and enhance project erection efficiency. This objective aims to optimize construction efficiency, minimize onsite labor requirements, and ensure timely project completion while upholding high quality standards.

12.B STRUCTURAL SYSTEMS

There are no specific limitations on use of gravity and lateral load-resisting structural systems other than as prescribed by the California Building Code (CBC). The structural engineer shall submit written documentation to the architect describing how the recommended gravity load and lateral load system will respond to the performance objectives.

Structural components, systems, and methods of design not specifically recognized by the CBC are permitted under approved requests for alternative means of compliance. Criteria for such components or systems shall be reviewed by one or more peer reviewers acceptable to the Judicial Council and shall be submitted to the council for approval in accordance with provisions established by the CBC.

12.C CRITERIA FOR SERVICE LOADS

The following criteria and performance goals shall apply to court facilities.

**DIVISION TWO:
TECHNICAL CRITERIA**

11 Architectural Criteria

12 STRUCTURAL CRITERIA

- 12.A Objectives
- 12.B Structural Systems
- 12.C Criteria for Service Loads
- 12.D Criteria for Rare Loads
- 12.E Life Cycle Cost Analysis
- 12.F Quality Assurance
- 12.G Fire-Resistive Ratings of Structural Elements

13 Mechanical Criteria

14 Building Management System Criteria

15 Electrical Criteria

16 Lighting Criteria

17 Network and Communication Systems

18 Audiovisual Systems

19 Acoustical Criteria

20 Fire Protection Criteria

1. Gravity Loads

Court facilities shall be designed for the live loads established by the CBC. Live loads shall be based on the use and room occupancy of the building area under consideration and shall consider movable partitions in open office locations.

Superimposed dead loads shall include, but are not limited to, mechanical, electrical, plumbing, solar, and fire-protection equipment and distribution systems; ceilings and suspended soffits; raised floors, ramps, platform assemblies, built-in partitions, finishes, and cladding; and telecom, audiovisual, and fire alarm equipment and distribution systems.

2. High-Density Files

Areas that support high-density files shall be designed for a 250-pounds-per-square-foot live load.

3. Floor Vibration: Human Comfort

Floors shall be designed to limit the floor acceleration by controlling floor vibration from footfall to achieve acceptable human-comfort performance levels. The recommended criteria in table 12.1 are based on the dynamic response of floor systems to walking excitation. The acceleration limits are based on American Institute of Steel Construction (AISC) *Design Guide 11*. The floor system shall be considered satisfied if the peak acceleration, a_p , due to walking excitation as a fraction of the acceleration of gravity, g , does not exceed the acceleration limit, a_0/g , for the appropriate room occupancies as shown in table 12.1.

Table 12.1 Human Comfort Performance Levels
Floor Vibration Acceptance Criteria (AISC) Recommended Values of Parameters and a_0/g Limits

BUILDING OCCUPANCY	CONSTANT FORCE, P_0	DAMPING RATIO, β	ACCELERATION LIMIT, $a_0/g \times 100\%$	QUALITATIVE PERFORMANCE LEVEL
Typical Use and Occupancy	65 lb	0.05	0.5%	Slightly Perceptible
Courtroom	65 lb	0.05	0.5%	Slightly Perceptible
Jury Assembly	65 lb	0.05	0.5%	Slightly Perceptible
Offices	65 lb	0.05	0.5%	Slightly Perceptible
General Assembly	65 lb	0.02	1.5%	Distinctly Perceptible
Corridors	65 lb	0.02	1.5%	Distinctly Perceptible
Monumental Stair	92 lb	0.01	1.5%	Distinctly Perceptible
Footbridge – Indoor	92 lb	0.01	1.5%	Distinctly Perceptible
Footbridge – Outdoor	92 lb	0.01	5.0%	Strongly Perceptible

Notes: Peak acceleration, a_p , due to walking excitation:

$$\frac{a_p}{g} = \frac{P_0 \exp(-.35f_n)}{\beta W}$$

P_0 = Constant force representing the excitation, pounds.

f_n = Fundamental natural frequency of a beam or joist panel, a girder panel, or a combined panel, as applicable, modal damping ratio, and effective weight supported by the beam or joist panel, girder panel, or combined panel, as applicable.

β = Modal damping ratio.

W = Effective weight supported by the beam or joist panel, girder panel, or combined panel, as applicable.

ASCE = American Society of Civil Engineers

NSC = nonstructural seismic coordinator

4. Floor Vibration: Equipment

Vibration from equipment will be controlled locally by isolation under the direction of others, such as the mechanical engineer, acoustical consultant, or equipment supplier. The structural engineer shall confirm with the architect that the structure requires nothing special to minimize vibrations from sources other than footfall.

12.D CRITERIA FOR RARE LOADS

1. Earthquake

Seismic performance of all new Judicial Council facilities is intended to be higher than that of buildings designed in accordance with prescriptive code provisions. This performance will be achieved through design and quality assurance.

The Judicial Council may designate specific buildings to be designed for enhanced seismic performance. *Enhanced seismic performance* refers to controlling earthquake damage to a building in order to limit the expected loss of use of the building after an earthquake. *Enhanced seismic performance* is required for high-rise court buildings assigned to Seismic Design Category E.

2. Risk Category

The CBC requires all buildings and structures to be assigned to a risk category, ranging from I (low hazard to human life, unoccupied structures) to IV (buildings and other structures that are deemed essential and must remain operational). Risk category is used to determine importance factors (as defined in the CBC) for amplifying loads and enhancing seismic responses; ensuring that ductile, lateral force-resisting systems are used in areas of high seismicity; and controlling building deformations in relation to buildings' and structures' uses and risk to human life and safety.

All new court facilities will be assigned to Risk Category III unless an alternative risk category is established for the project.

3. Seismic Design Category

All structures are assigned to a seismic design category based on mapped seismic acceleration parameters and risk category. Seismic design categories range from A (no seismic hazard) to F (extreme seismic hazard on essential services buildings). A seismic design category is used to ensure that the selected ductile structural systems are detailed for seismic activity resistant design.

All new court facilities shall be assigned to Seismic Design Category D minimum, regardless of mapped or site-specific acceleration parameters.

4. Normal Seismic Performance: Structural Components

Normal structural seismic performance objectives must be met by thorough conformance with the principles and provisions of the CBC using either mapped seismic acceleration parameters or site-specific seismic ground motions.

5. Normal Seismic Performance: Nonstructural Components

- a. Acceptable performance of nonstructural components and systems shall be achieved by implementing CBC requirements during the design and construction phases.
- b. For nonstructural components, the design team is encouraged to specify preapproved standards such as:

- DSA Interpretation of Regulations (IR) 25-2.13, for metal suspension systems for lay-in panel ceilings;
- DSA IR 25-3.13, for suspended gypsum board ceilings; and
- HCAI Preapproved Details.

6. Enhanced Seismic Performance: Structural Components

- Enhanced seismic performance requires a performance-based seismic design process such as that outlined in FEMA P-58. The structural engineer shall work jointly with the Judicial Council, other design professionals, and other stakeholders to identify desired building performance objectives at the outset of a project. Upon selection of performance objectives, designs must be developed, and performance assessments completed for the proposed structural systems.
- Analysis and design methods shall explicitly account for nonlinear behavior of the designated lateral force-resisting system's members and connectors using procedures such as the nonlinear static procedure or the nonlinear dynamic procedure stated in American Society of Civil Engineers' Standard ASCE 41 and/or FEMA P-58.
- Seismically isolated systems and damping systems may be used to provide enhanced seismic performance.
- The Judicial Council will review and approve the enhanced seismic performance design criteria and may appoint an independent peer review team to evaluate the proposed criteria and analysis methods.

7. Enhanced Seismic Performance: Nonstructural Components

When enhanced seismic performance is required by the Judicial Council, the amendments to the CBC by the DSA-SS that pertain to nonstructural components shall be adhered to.

The design team is encouraged to use and specify preapproved standards.

8. Nonstructural Seismic Coordinator

For all projects, the project's registered design professional in responsible charge shall act as the nonstructural seismic coordinator (NSC). The NSC shall establish and coordinate design criteria and performance specifications for nonstructural components during the design phase. In addition, the NSC shall identify equipment critical to continued building function and occupancy, as specified by the CBC and the Judicial Council, and shall assist the Judicial Council to determine requirements for prequalification of such equipment.

During the construction phase, the NSC shall coordinate delegated design teams and review deferred approval submittals before submission to the authority having jurisdiction. The NSC shall be the project architect or project structural engineer, or may be an independent registered design professional retained by the registered design professional in responsible charge.

9. Blast

See chapter 4, Courthouse Security, for blast criteria.

10. Wind

Wind design shall be in accordance with the CBC, unless otherwise specified by the Judicial Council. Because of enhanced performance objectives or siting conditions, the Judicial Council may select certain buildings for site-specific wind studies. Such an analysis will

DIVISION TWO: TECHNICAL CRITERIA

11 Architectural Criteria

12 STRUCTURAL CRITERIA

- 12.A Objectives
- 12.B Structural Systems
- 12.C Criteria for Service Loads
- 12.D Criteria for Rare Loads
- 12.E Life Cycle Cost Analysis
- 12.F Quality Assurance
- 12.G Fire-Resistive Ratings of Structural Elements

13 Mechanical Criteria

14 Building Management System Criteria

15 Electrical Criteria

16 Lighting Criteria

17 Network and Communication Systems

18 Audiovisual Systems

19 Acoustical Criteria

20 Fire Protection Criteria

Life cycle cost analysis (LCCA) is a useful indicator in evaluating total ownership cost of design alternatives over a 25-year-or-greater useful life of the facility and identifies cost alternatives. See 1.A, Functional Usefulness, Physical Durability, and Maintainability, for more information.

determine design parameters for the structural system, exterior cladding, roof systems, ornamentation, and pedestrian-level wind environment. Wind analysis and modeling shall be based on local climate, wind environment, and orientation of critical wind direction in compliance with the CBC.

11. Flood, Snow, and Rain

Parameters for design for flood, snow, and rain loading shall be in accordance with requirements of the local jurisdiction in which the court facility is to be constructed.

12.E LIFE CYCLE COST ANALYSIS

1. Objectives

Selection of building components, materials, and structural systems must take into account long-term capital cost impacts of estimated losses resulting from expected earthquakes and other rare and damaging events.

Loss estimates shall be evaluated using life cycle cost analysis (LCCA). The Judicial Council will consider analysis estimates in determining acceptability of design alternatives along with other factors. Refer to chapter 1, General Principles, for overall project life cycle cost analysis objectives and methodologies.

2. Methodologies and Standards

- a. The LCCA methodology (refer to tool 1, Life Cycle Cost Analysis) should be able to synthesize hazards, fragilities, and consequences to provide measurable and useful estimates of capital losses and impacts due to business interruption. The LCCA should be able to estimate benefit-cost analysis and the total cost of ownership for design options and alternatives. The LCCA should be based on known and established methods and techniques, including simulations to estimate probable losses at various confidence levels for individual event scenarios or over a considered time frame.
- b. Seismic risk assessments should be developed using tools that have been validated for intended use, with due consideration in the interpretation of results based on limitations of programs, methodologies, assumptions, and variables.
- c. Selection of LCCA programs and tools shall be reviewed with the Judicial Council before implementation.

3. Seismic Hazard Risk Assessment

- a. In estimating losses from expected earthquakes, the LCCA shall be based on probabilistic performance-based seismic hazard risk assessments. The LCCA should consider losses resulting from the following:
 - Structural damage
 - Nonstructural damage
 - Damage to building contents
 - Disruption of building functions (loss of use)
 - Long-term environmental impacts
- b. Estimates of the total cost of ownership and benefit-cost ratios may be used to provide relative comparisons of alternative options with respect to a baseline option. Project cost estimation should be used to establish the baseline option costs with respect to

alternative option costs in evaluating design options in the LCCA. Comparative results should be used to evaluate overall cost impacts and architectural tradeoffs resulting in consideration of various structural system configurations and options. These options may include comparisons such as normal versus enhanced seismic performance objectives, use of moment frames versus braced frames, impact of column size on floor plan and program, impact of beam depth on typical floor-to-floor height, and steel versus concrete construction alternatives. See 1.A, Functional Usefulness, Physical Durability, and Maintainability, for more information on life cycle cost analysis.

4. Environmental Impacts

Sustainable design strategies (see 1.D, Sustainable Design) shall also utilize life cycle cost analysis to assess relative environmental impacts of selected structural system options and alternatives. LCCA is a useful tool in determining lowest-cost structural system alternatives in the consideration and implementation of “state-of-the-practice” sustainable and environmental design principles. For structural systems, analysis is emphasized for *embodied energy*, or the life-cycle raw material extraction, transport, manufacture, assembly, installation, disassembly, and deconstruction and/or decomposition that make up the base building’s materials.

12.F QUALITY ASSURANCE

- a. The registered design professional in responsible charge shall prepare a statement of special inspection that complies with the provisions of the CBC. This statement shall be inclusive, covering all special inspections and tests—both structural and nonstructural—required for the project. A comprehensive list of special inspections and tests shall be included in the working drawings deliverable by the registered design professional.
- b. Structural observation is required for all new court facilities. The registered design professional in responsible charge shall prepare a schedule identifying the phases of construction to be observed.

12.G FIRE-RESISTIVE RATINGS OF STRUCTURAL ELEMENTS

The architect, fire-protection consultants, and structural engineer shall coordinate to clearly identify the fire-resistive ratings of all structural elements required to have a rating by the current California Building Code, volume 2, part 1, chapters 6 and 7.

DIVISION TWO: TECHNICAL CRITERIA

11 Architectural Criteria

12 STRUCTURAL CRITERIA

- 12.A Objectives
- 12.B Structural Systems
- 12.C Criteria for Service Loads
- 12.D Criteria for Rare Loads
- 12.E Life Cycle Cost Analysis
- 12.F Quality Assurance
- 12.G Fire-Resistive Ratings of Structural Elements

13 Mechanical Criteria

14 Building Management System Criteria

15 Electrical Criteria

16 Lighting Criteria

17 Network and Communication Systems

18 Audiovisual Systems

19 Acoustical Criteria

20 Fire Protection Criteria

DRAFT

13

DIVISION TWO: TECHNICAL CRITERIA

MECHANICAL CRITERIA

SECTION	TOPIC	PAGE
13.A	Objectives	13.2
13.B	HVAC Criteria	13.3
13.C	Humidification and Water Treatment	13.11
13.D	Mechanical Requirements for Specific Spaces	13.11
13.E	Plumbing and Piping Systems Criteria	13.13
13.F	Insulation	13.17
13.G	Thermometers and Gauges	13.18

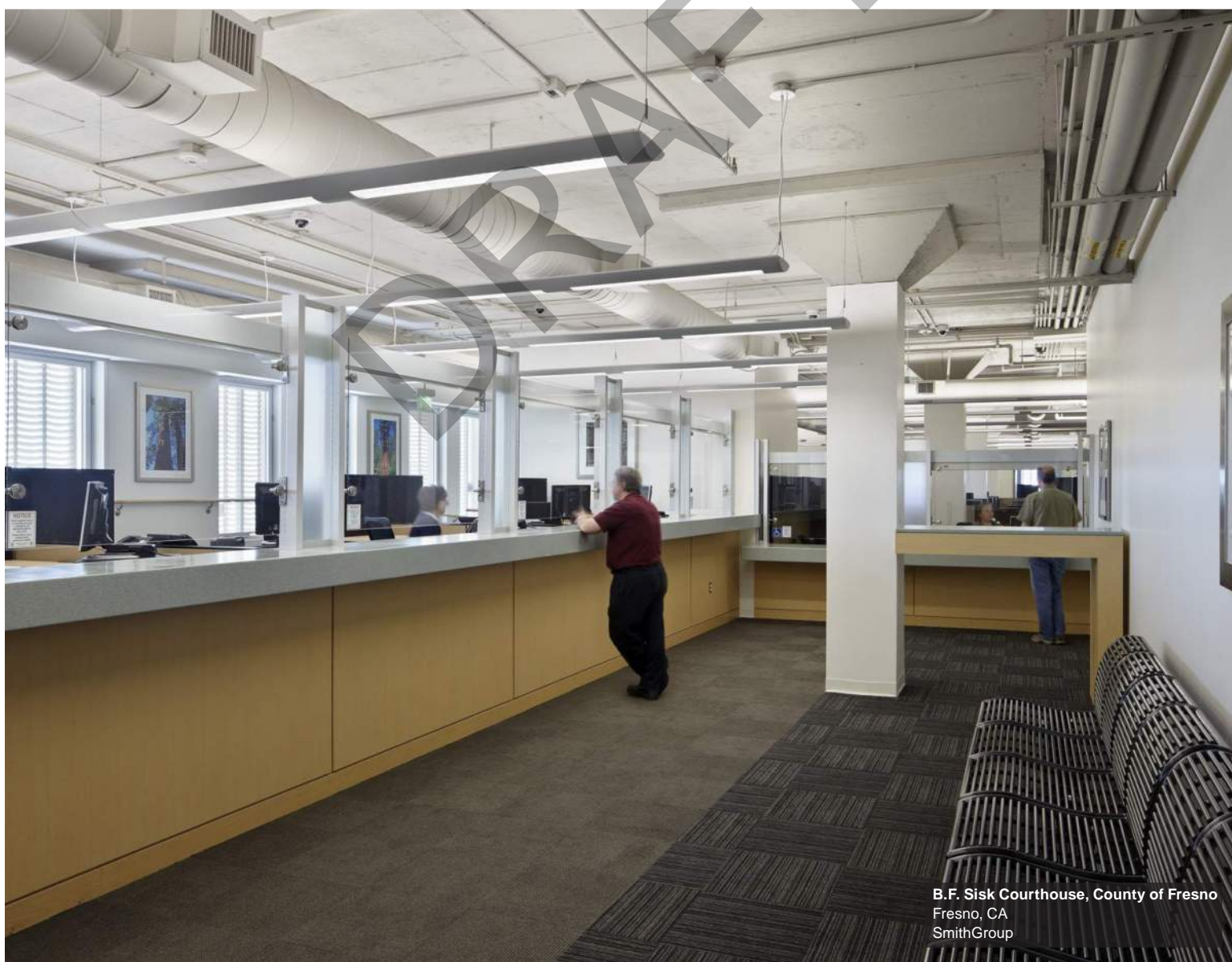

B.F. Sisk Courthouse, County of Fresno
Fresno, CA
SmithGroup

This chapter identifies the program and criteria for heating, ventilation, and air-conditioning (HVAC), plumbing, and piping systems.

Maintainability and reliability are essential requirements of the Judicial Council for facility operations.

13.A OBJECTIVES

The conservation of energy and natural resources shall be weighed against the initial construction cost and future operating cost when incorporating the mechanical concepts into the design to ensure that the project's goals focus on the total life cycle operating costs of the facility. Design mechanical systems to meet building performance objectives, including sustainability and energy conservation, maintenance and reliability, and flexibility for changes.

1. Performance

The design solutions shall not sacrifice the basic needs of one program area to optimize another. Instead, the mechanical designs must optimize the program to ensure attainment of all critical performance goals.

2. Sustainability and Energy Conservation

The design of mechanical systems shall combine with other component designs to produce a building that meets the project's programmed sustainability and energy-efficiency goals, as referenced in chapter 1, General Principles.

3. Maintenance and Reliability

Maintainability and reliability are essential requirements of the Judicial Council in facility operations. The design and installation of all mechanical equipment shall provide sufficient clearance to allow easy maintainability, including space for removal and replacement of filters in ceiling equipment, boilers, chillers, cooling towers, pumps, motors, building automation controllers, fire and life-safety dampers, and air-handling equipment. Systems shall have reliability over the functional lifespans listed in tool 1, Life Cycle Cost Analysis.

4. Flexibility for Change

Design systems to provide for the range of loads anticipated to support the use of all principal spaces in the court building.

5. Standby Capacity

Standby capacity shall be designed into mechanical systems, enabling continuous operation during repair or replacement of a failed piece of equipment or components. Unless otherwise noted, standby units shall be sized based on an N+1 approach. The N+1 approach provides for one additional unit sized to meet the largest unit of the given equipment type. Standby capacity is mandated only in the case of systems serving equipment identified as critical to the life-safety and communication systems in the building program. For example, depending on size of the main distribution frame (MDF) room (specifically for medium and large courthouse projects), consider using coolant distribution units that are server-rack mounted. Doing so will reduce the physical size of an airside cooling solution, which will also reduce impact on the environment—acoustic impact, congestion above ceiling, and valuable floor space for floor-mounted computer room air-conditioning units—outside the room.

6. Rational Analysis

A rational analysis shall be performed and a report prepared to establish minimum requirements for the design, installation, and acceptance testing of smoke control systems that are intended to provide a tenable environment for the evacuation or relocation of occupants. The report, and associated design, complying with the California Building Code, shall be submitted with the construction documents to the authority having jurisdiction.

13.B HVAC CRITERIA

1. Indoor Design Conditions

See table 13.1 for requirements.

2. Temperature Control Zone

Target the interior temperature control zone size to avoid exceeding 1,500 gross square feet for open areas, or a maximum of three enclosed offices. Corner offices shall be independent zones. Provide independent zones for each courtroom, chambers suite, jury deliberation room, entrance lobby, mailroom, staff lounge, conference room, child waiting area, and equipment rooms. Provide a zone map for review by the Judicial Council before any associated heating, ventilation, and air-conditioning (HVAC) design.

3. Air Distribution

3.1 System Requirements

- a. Based on size and complexity of the building, air distribution systems may consist of air-handling units (AHUs), central direct expansion (DX) air conditioners, variable refrigerant flow (VRF) systems, or built-up central air-handling systems, with the decision based on the life cycle cost analysis (LCCA) and whole-building cost analysis.
- b. AHUs provide flexible zone control through use of multiple smaller units. AHU casing construction details are included in table 13.3, at the end of this chapter. Central systems shall incorporate components similar in quality to those in table 13.3.
- c. Systems shall be designed for turndown to ensure that short-cycling during shoulder seasons does not occur.
- d. Design air ventilation rates shall comply with the latest adopted version of ASHRAE Standard 62.1, Ventilation for Acceptable Indoor Air Quality, and California Code of Regulations, title 24. Thermal comfort conditions shall comply with the latest version of ASHRAE Standard 55, Thermal Environmental Conditions for Human Occupancy. Demand control ventilation using carbon dioxide (CO₂) sensors per occupancy zone shall be applied appropriately as defined by the building code occupancy classification per individual programmed space.
- e. Demand ventilation controls shall maintain CO₂ concentrations less than or equal to 600 parts per million plus the outdoor air CO₂ concentration in all rooms that require CO₂ sensors by code.
- f. If used, variable air volume (VAV) terminal boxes selected shall be pressure-independent and Air-Conditioning, Heating, and Refrigeration Institute's AHRI Standard 880 certified. VAV terminal boxes and their associated building management system (BMS) controllers shall be located in an accessible manner for replacement and maintenance. VAV terminal boxes shall incorporate Belimo or approved equal direct digital control actuator, including a five-year warranty.
- g. All terminal ceiling diffusers or booted-plenum slot diffusers shall be specifically designed for VAV air distribution. Booted-plenum slots shall not exceed 5' in length unless more than one source of supply is provided. Diffuser spacing selection shall be based on the predominant air volume range.

DIVISION TWO: TECHNICAL CRITERIA

11 Architectural Criteria

12 Structural Criteria

13 MECHANICAL CRITERIA

13.A Objectives

13.B HVAC Criteria

13.C Humidification and
Water Treatment

13.D Mechanical Requirements
for Specific Spaces

13.E Plumbing and Piping
Systems Criteria

13.F Insulation

13.G Thermometers and
Gauges

14 Building Management
System Criteria

15 Electrical Criteria

16 Lighting Criteria

17 Network and
Communication Systems

18 Audiovisual Systems

19 Acoustical Criteria

20 Fire Protection Criteria

Important References

ASHRAE Standards 55, 62.1, and 90.1

EISA = Energy Independence and Security Act of 2007

NEC = National Electrical Code

NEMA = National Electrical Manufacturers Association

NFPA = National Fire Protection Association

SMACNA = Sheet Metal and Air Conditioning Contractors' National Association

Table 13.1 Indoor Design Conditions

ROOM TYPE	HEATING DESIGN TEMP	COOLING DESIGN TEMP	DESIGN OCCUPANT DENSITY	DESIGN POWER DENSITY
Lobby	72°F	75°F	Per CA Mech. Code	W/SF
Conference Rooms	72°F	75°F	Per CA Mech. Code	2.0 W/SF
Offices	72°F	75°F	Per CA Mech. Code	1.2 W/SF
Break Rooms	72°F	75°F	Per CA Mech. Code	1.5 W/SF
Waiting Rooms	72°F	75°F	20 SF/person	1.5 W/SF
Public Gallery/Passage	72°F	75°F	50 SF/person	0.5 W/SF
Public Toilet Rooms*	72°F	75°F	Indirect Thru Exhaust Makeup	0.5 W/SF
Holding Cell/Room*	72°F	75°F	Per CA Mech. Code	0.5 W/SF
Transformer/Switchgear Room	N/A	95°F	N/A (normally unoccupied)	Project Specific
IDF Rooms	N/A	75°F	N/A (normally unoccupied)	Project Specific
MDF Room	N/A	75°F	N/A (normally unoccupied)	Project Specific
UPS Room	77°F	77°F	N/A (normally unoccupied)	Project Specific
Janitor Closets*	N/A	75°F	Indirect Thru Exhaust Makeup	N/A
Copy Rooms	72°F	75°F	Indirect Thru Exhaust Makeup	Project Specific
Kitchens	72°F	75°F	Per CA Mech. Code	2.5 W/SF
Coffee Stations	72°F	75°F	Per CA Mech. Code	1.5 W/SF
Storage (<150 SF)	N/A	N/A	N/A	N/A
Storage (≥150 SF)	N/A	N/A	150 SF/person	N/A
Courtroom	72°F	75°F	Per CA Mech. Code	0.5 W/SF
Jury Services	72°F	75°F	20 SF/person	1.0 W/SF
Jury Deliberation Rooms	72°F	75°F	20 SF/person	2.0 W/SF
Judicial Chambers	72°F	75°F	150 SF/person	1.2 W/SF

Notes:

This table lists initial suggested values only—actual values to be verified by design team. Suggestions do not override code requirements.

Suggestions are intended for preliminary HVAC analysis only and may differ from those used by other design disciplines.

Suggestions are independent of task lights and audio/visual loads.

* 100% outside air; once-through air only.

W/SF = watts per square foot.

IDF = intermediate distribution frame.

UPS = uninterruptible power supply.

Table 13.2 Maximum Allowable Duct Velocities

NOISE CRITERIA	MAXIMUM ALLOWABLE DUCT VELOCITY (FPM)	
	MAIN	BRANCH
20	1,000	500
25	1,000	800
30	1,300	1,100
35	1,500	1,200
40	1,800	1,400

fpm = feet per minute.

- h. Ensure that the Air Diffusion Performance Index values remain above the specified manufacturer’s minimum. Diffusers shall be high-entrainment type (3:1 minimum) to maximize air velocity at low flow rates.
- i. All motors that are operated with variable-speed drives shall be provided with inverter-duty motors with Class F insulation per the National Electrical Code (NEC) and the National Fire Protection Association (NFPA) and shall include motor shaft grounding assemblies.
- j. Ductwork construction shall comply with Sheet Metal and Air Conditioning Contractors’ National Association (SMACNA) duct construction standards and shall be installed per the SMACNA duct cleanliness standard for new construction. The ductwork shall meet the acoustical requirements outlined in table 13.2 per maximum allowable duct velocities.
- k. Leakage testing shall be performed on all ductwork constructed greater than 3” pressure class in accordance with the SMACNA *HVAC Air Duct Leakage Test Manual* and all ductwork associated with the smoke control system (if applicable). Use minimum SMACNA seal class A for all ductwork. SMACNA leakage class for 2” and less shall be 16 for rectangular and 8 for round ductwork. SMACNA leakage class for 3” and higher shall be 4 for rectangular and 2 for round ductwork.
- l. Fabricate ductwork from galvanized steel, stainless steel, and/or aluminum sheet metal, depending on applications. Use low volatile organic compound duct sealant with Environmental Protection Agency listings. A factory-made Underwriters Laboratories’ (UL) Class 1 listed acoustical flex duct may be used for low-pressure ductwork connected to air devices and shall be installed in accordance with the SMACNA HVAC Duct Construction Standards: Metal and Flexible.
- m. For plenum and ducted returns, no more than 1,000 cubic feet per minute (cfm) shall be collected at any one return grille. When deemed necessary, all plenums shall be sealed airtight with respect to the exterior wall and roof slab or ceiling deck to avoid creating negative air pressure in exterior wall cavities that would allow intrusion of untreated outdoor air. All ductwork shall be insulated per the California Energy Code.
- n. Before building occupancy and after all interior finishes have been installed, install new filtration media and perform a building flush-out as outlined in the LEED Indoor Environmental Quality (EQ) credit: Indoor Air Quality

**DIVISION TWO:
TECHNICAL CRITERIA**

- 11 Architectural Criteria
- 12 Structural Criteria

13 MECHANICAL CRITERIA

- 13.A Objectives
- 13.B HVAC Criteria
- 13.C Humidification and Water Treatment
- 13.D Mechanical Requirements for Specific Spaces
- 13.E Plumbing and Piping Systems Criteria
- 13.F Insulation
- 13.G Thermometers and Gauges

- 14 Building Management System Criteria
- 15 Electrical Criteria
- 16 Lighting Criteria
- 17 Network and Communication Systems
- 18 Audiovisual Systems
- 19 Acoustical Criteria
- 20 Fire Protection Criteria

Important References*ASHRAE Handbook—
Fundamentals*

The climate zone at the project location, as assigned by the California Energy Commission's California Building Climate Zones, should be the basis for all calculations, as defined in the California Code of Regulations, title 24.

For information on life cycle cost analysis, see chapter 1, General Principles.

Assessment. In addition, perform the air testing outlined in the credit and provide to the Judicial Council the results that satisfy the credit requirements.

- o. Test and balance all systems by an Associated Air Balance Council (AABC) or National Environmental Balancing Bureau (NEBB) certified balance company.

3.2 Building Pressurization

Building pressurization shall meet the requirements of the latest version of *ASHRAE Handbook—Fundamentals*. Design the system to provide the required continuous positive pressure with respect to the outdoor environment. Principal spaces are to maintain positive pressure relative to circulation spaces; circulation spaces, building entrances, and public lobbies are to maintain positive pressure relative to the outdoors. Verification of required building pressurization shall be documented during the commissioning phase of building construction.

3.3 Air Intake and Exhaust

The placement, location, and quantity of outside air must comply with California Code of Regulations, title 24; ASHRAE Standard 62.1, Ventilation for Acceptable Indoor Air Quality; and the building security requirements. For security requirements, see chapter 4, Courthouse Security, and chapter 8, In-Custody Defendant Receiving, Holding, and Transport. The intake design shall minimize the entrainment of exhaust air. The outside air intake louvers shall be drainable stationary storm louver type with American National Standards Institute and Air Movement and Control Association (ANSI/AMCA) Standard 500-L. Inactive sections of intake and exhaust louvers shall be blanked off to eliminate outside air and particulate ingress into the building. Airflow stations shall be designed for and installed to directly measure the minimum required outside airflow into each air handling unit (see section 13.G). Furthermore, airflow station measurement and data shall be directly trended at the BMS front end for ongoing data analysis.

4. Internal Heat Gains

- a. Refer to table 13.1 for target values unless noted otherwise.
- b. Internal heat gains from all appliances (electrical, gas, or steam) shall be determined by manufacturer-provided heat gain and usage schedules, if available; heat gains from office equipment shall be based on manufacturer-provided data, if available, or the latest edition of *ASHRAE Handbook—Fundamentals*.
- c. Refer to electrical documents for the design lighting power density to be included in the associated HVAC load calculations.

5. Diversity

The designer should use diversity in sizing systems' peak capacities. The diversity factor shall be adjusted to the specific project. Diversity is defined as the concurrent zone peak loads compared to the sum of all peak building zone loads. Although the Judicial Council cannot suggest specific diversity criteria for the coincidence of weather (design cooling days), occupancy, court operation, judges' chambers, lighting, and other functions within the building, several general ideas are suggested.

- a. Diversity at the AHU (system) level is appropriate and should be taken to prevent oversizing of systems.
- b. This diversity should not be taken at the zone level.
- c. Greater diversity should be considered at the central plant or with applications of district energy.

- d. All lighting will not be assumed to be energized at the same times throughout the entire building. At least 10 percent of the lights can be assumed to be off on a system basis. Advanced lighting controls, detailed in chapter 16, Lighting Criteria, can generate even more significant savings.
- e. Court operation and occupancy will vary significantly on a monthly and weekly basis. The impact of varied occupancy should be considered based on past courthouse occupancy and performance data and project team judgment. Occupancy data shall be leveraged to determine diversity for all applicable systems before HVAC system design.
- f. Judicial chambers will likely be generally occupied, yet conference functions that support the chambers will generally share occupancy. An office occupant may also be a conference participant, so avoid double counting.
- g. Simultaneous operation of all these individual diversified operations should also be considered (further combined diversity).

6. Air-Conditioning Cooling Systems

6.1 Chilled Water Systems

- a. District-chilled water, if available, shall be used if it is determined to be economical and reliable through a life cycle cost analysis. In the LCCA, use high-efficiency chillers that do not exceed 0.585 kilowatt (kw)/ton and 0.380 integrated part load value (IPLV). Chiller refrigerant leak detection systems shall be connected to the BMS with remote alarms.
- b. The cooling system shall consist of multiple units of each equipment type, and the total plant capacity shall be 120 percent of the building cooling design load. If systems are deemed to serve critical areas, the system design shall be based on an N+1 approach as described in section 13.A.5. Redundancy analysis shall be provided for review and approval by the Judicial Council for any proposed chilled water system that will use an ice storage system. The redundancy analysis shall demonstrate that the combined cooling capacity of the chiller and the ice storage system provides a minimum of 60 percent of the design load across multiple ice charging cycles, assuming one chiller is nonoperational because of maintenance.
- c. All chillers in a facility shall use the same nonproprietary refrigerant and shall avoid use of refrigerants that do not comply with California Air Resources Board initiatives and regulations. If the operating conditions dictate, propylene glycol may be used at the required concentrations to prevent freezing. When propylene glycol is used, include a leak detection system. Ethylene glycol shall not be used. Chillers shall be equipped with variable-frequency drives when deemed appropriate based on the California Energy Commission's California Building Climate Zones as defined in California Code of Regulations, title 24. The design chilled water temperature difference (delta T) across the chillers' evaporators shall be at least 14 degrees Fahrenheit (°F). Variable supply air set point control (chapter 14, section 14.D.1) shall be applied to reduce loads and increase the efficiency of the chiller plant.
- d. All chillers shall be piped to a common chilled water header with provisions to sequence chillers online to match the load requirements. All required auxiliaries for the chiller systems shall be provided with expansion tanks, heat exchangers, water treatment, and air separators. When multiple chillers are used, automatic shutoff valves shall be provided for each chiller. Chiller condenser piping shall be equipped with recirculation and bypass control

DIVISION TWO: TECHNICAL CRITERIA

11 Architectural Criteria

12 Structural Criteria

13 MECHANICAL CRITERIA

13.A Objectives

13.B HVAC Criteria

13.C Humidification and Water Treatment

13.D Mechanical Requirements for Specific Spaces

13.E Plumbing and Piping Systems Criteria

13.F Insulation

13.G Thermometers and Gauges

14 Building Management System Criteria

15 Electrical Criteria

16 Lighting Criteria

17 Network and Communication Systems

18 Audiovisual Systems

19 Acoustical Criteria

20 Fire Protection Criteria

valves as needed to maintain incoming condenser water temperature within the chiller manufacturer's minimum requirement.

- e. Multiple cell cooling towers and isolated basins are required. The number of cells and associated capacity shall match the number of chillers. Supply piping shall be connected to a manifold to allow for any combination of equipment use. Multiple towers shall have equalization piping between cell basins. Equalization piping shall include isolation valves between each cell. Supply and return lines for each cell shall be provided with automatic isolation valves. Provide a centrifugal separation filtration system in areas deemed subject to airborne debris. Cooling towers shall have ladders and platforms as required for inspections and replacement of components. Provide stainless steel basins to reduce life cycle cost based on local water quality.
- f. Cooling tower sizing shall be on a life cycle basis, taking into consideration operational energy and water consumption rather than first cost. Cooling tower controls shall include a pH (acidity) and conductivity controller connected to the water treatment system by adding chemicals that regulate the pH in the system to prevent corrosion and scaling and to facilitate water conservation through increased cycles of concentration. Flow meters connected to the BMS control system must be specified on makeup and blowdown water lines.
- g. Pumps shall be of a centrifugal type and shall generally be selected to operate at 1,750 revolutions per minute (rpm) maximum peak efficiency. Both partial and full load must fall on stable areas of the pump curve. The number of primary chilled water and condenser water pumps shall be equal to the number of chillers. The specified pump motors shall not overload throughout the entire range of the pump curve. The pump associated with each individual cooling tower and chiller group shall be arranged with piping, valves, and controls to allow for independent, parallel operation of each chiller-cooling tower group.
- h. All motors that are operated with variable-speed drives shall be inverter-duty motors with Class F insulation per NEC and NFPA and shall include motor shaft grounding assemblies.
- i. Chilled water systems shall be submetered via British thermal unit (BTU) meters that report data back to the central BMS front end for ongoing data analysis. Real-time BTU data shall be exposed on the front end for use by building engineers.

6.2 Direct Expansion Systems

Direct expansion (DX) evaporators with condensing units are not allowed unless, in the schematic design phase, the chilled water system application does not have a favorable life cycle cost or the application requires a DX approach. The HVAC designer is required to first consider and rule out using chilled water concepts before specifying any high-efficiency DX refrigeration equipment. Water conservation efforts shall be incorporated into the LCCA when considering system alternatives.

6.3 Alternative Systems

Alternative solutions may be provided that meet the requirements and the associated energy goals of the current California Building Code. Neither active nor passive radiant chilled beams, panels, or sails are permitted.

7. Heating Systems

7.1 Requirements per Heating System

- a. Water heating systems: Low-temperature water heating is the preferred system. Supply temperatures and the corresponding temperature drops for space heating hot water systems must be set to best suit the equipment being served. The temperature drop for terminal unit heating coils shall be 30°F–40°F. Design water velocity in piping so as not to exceed 8' per second, or design pressure friction loss in piping systems not to exceed 4' of head loss per 100' of pipe, whichever pipe size is larger, and not less than 4' per second.

All boilers for hydronic water heating applications shall be condensing type, with the working pressure and maximum temperature limitation stated, and shall be installed in a dedicated mechanical room with all provisions made for chimney, flue stack, and combustion air. In general, three boilers each sized for 40 percent of the full cold start preheating load shall be provided. For installations where the ASHRAE winter design is 34°F and above, a minimum of two equally sized units at 55 percent of the full cold start preheating load shall be provided. The designer shall provide load calculations including safety factors used in final equipment selections.

All boiler emissions shall comply with local air quality regulations. The products of combustion from fuel-fired appliances and equipment shall be terminated to the outside of the building through the use of chimneys. All boilers shall be piped to a common heating water header, with provisions to sequence boilers online to match the load requirements. All required auxiliaries for the boiler systems shall be provided with expansion tanks, heat exchangers, water treatment, and air separators. Variable supply air set point control shall be applied to reduce loads and increase efficiency of boiler plant. See chapter 14, Building Management System Criteria.

Rooms housing combustion boilers or water heaters shall provide combustion air openings per California Mechanical Code, chapter 7, Combustion Air.

- b. Radiant heating systems: Radiant heating systems are not permitted.
- c. Fin-tube heating systems: When fin-tube radiation is used, the design shall incorporate individual zone thermostatic control capable of connecting to a self-contained microprocessor and an HVAC building control system.
- d. Variable volume reheat boxes: A variable air volume system with hot water reheat shall be used for zone applications. VAV shutoff boxes that incorporate zone occupancy per California Code of Regulations, title 24, may be used with air distribution systems to eliminate the need for reheat.
- e. Variable volume with fan-powered boxes: Fan-powered boxes may have water heating coils for maintaining temperature conditions in the space under partial load conditions.
- f. Water coils for heating: All zones on the perimeter and top floor of the building shall contain water coils for heating.
- g. Alternative systems: Other systems may be considered that meet current code and the energy goals of California Building Code.

7.2 General Requirements

- a. The Judicial Council requires low-temperature (condensing) hot water heating systems, with the lowest working pressure suitable for the system and a

DIVISION TWO: TECHNICAL CRITERIA

11 Architectural Criteria

12 Structural Criteria

13 MECHANICAL CRITERIA

13.A Objectives

13.B HVAC Criteria

13.C Humidification and
Water Treatment

13.D Mechanical Requirements
for Specific Spaces

13.E Plumbing and Piping
Systems Criteria

13.F Insulation

13.G Thermometers and
Gauges

14 Building Management
System Criteria

15 Electrical Criteria

16 Lighting Criteria

17 Network and
Communication Systems

18 Audiovisual Systems

19 Acoustical Criteria

20 Fire Protection Criteria

Vibration and Acoustical Isolation

Refer to chapter 19, Acoustical Criteria, which shall govern in case of conflict. Refer to and incorporate the basic design techniques described in *ASHRAE Handbook—HVAC Applications*.

maximum temperature limitation of 160°F.

- b. When steam is furnished to the building, it must be converted to hot water with a submetered heat exchanger in the mechanical room near the entrance into the building. Steam heating is discouraged inside the building, other than the conversion of steam to hot water in the mechanical room. The designer must investigate the use of district steam condensate for preheating domestic hot water.
- c. Hot water and chilled water air systems must use a four-pipe main distribution system. Dual temperature piping systems are not permitted.

8. Vibration and Acoustical Isolation

- a. Mechanical room isolation: Acoustical isolation floors shall be considered for major mechanical rooms located in penthouses or at intermediate levels of mid-rise construction.
- b. Shaft requirements: Mechanical shafts and chases shall be closed at top and bottom, as well as at the entrance to the mechanical room. Any piping and ductwork shall be isolated as it enters the shaft to prevent propagation of vibration to the building structure. All openings for ducts and piping must be sealed. Shafts dedicated to gas piping must be ventilated.
- c. Isolators: Isolators shall be specified by type and deflection, not by isolation efficiency. Specifications shall be worded so that isolation performance becomes the responsibility of the equipment supplier.
- d. Vibration control: Concrete inertia bases shall be delineated for reciprocating equipment and all pumps unless equipment is installed on slab on grade.
- e. Ductwork: The design shall delineate the methods to reduce fan-generated noise immediately outside any mechanical room. The ductwork design shall appropriately address the airborne-generated equipment noise, equipment vibration, duct-borne fan noise, duct breakout noise, airflow-generated noise, and duct-borne crosstalk noise. All ductwork connections to equipment having motors or rotating components shall be made with aligned, 6" long, double-walled UL-labeled, flexible connectors.
- f. Piping hangers and isolation: The design shall analyze the need for isolation hangers for piping to address acoustical and expansion concerns. Piping hangers and supports shall be designed in accordance with the applicable codes.
- g. Noise control in VAV systems: The system-generated sound levels at maximum flow must be carefully evaluated to ensure that acoustical performance conforms to project-specific targets. Inlet guide vanes shall be evaluated for noise in their most restricted position. Duct noise control shall be achieved by controlling air velocity using sound attenuators. Terminal units shall be selected so that design air volume is approximately three-quarters of the terminal box's maximum capacity. Volume dampers in terminal units shall be located at least 6" from the closest diffuser, and the use of grille-mounted balance dampers shall be restricted except in applications with accessibility problems and only on approval of the Judicial Council.
- h. VAV box sound attenuation: The VAV boxes and associated attenuation lining shall incorporate fiber-free insulation or foil-faced insulation duct materials. The attenuation materials shall be appropriately sealed and either covered with reinforced aluminum-laminated foil liner or coated with water-based sealant tested and approved for air erosion per UL 181 or ASTM C1071. The materials shall not promote or support the

growth of fungi or bacteria, in accordance with UL 181 and ASTM G21. All exposed edges shall be sealed with sealant approved per NFPA 90A.

13.C HUMIDIFICATION AND WATER TREATMENT

1. Humidifiers and Direct Evaporative Coolers

Courthouse spaces shall not be humidified. Direct evaporative coolers are not permitted because of maintenance and room moisture content concerns, unless approved by the Judicial Council. HVAC systems implementing an evaporative cooler to condition electrical rooms shall use only indirect or direct-indirect units to eliminate the possibility of water carryover in the HVAC system, which can damage electrical equipment.

2. Relative Humidity Controls Criteria

- a. Summer: Unless noted to the contrary in the project program, inside relative humidity is not to be directly controlled. Dehumidification is a byproduct of the cooling process.
- b. Winter: Do not add moisture to the air stream. When the program document indicates that humidification in the winter is required, the humidification equipment shall be sized to avoid condensation on inside surfaces whether visible or concealed.

3. Water Treatment

- a. A water treatment specialist must design the water treatment for closed and open hydronic systems with consideration of the operational and maintenance needs of all system equipment, including such components as boilers, chillers, cooling towers, other heat exchangers, pumps, and piping. The design must inhibit biological growth, address dissolved solids and scaling, and provide corrosion protection. Before design of the water treatment system, confirm pH, free chlorine, alkalinity, total dissolved solids, iron content, soluble copper, aerobic plate, and industry standards for *Legionella* management with the Judicial Council.
- b. As part of the water treatment plan, specify coupon racks or an equivalent electronic monitoring system for corrosion in condenser water loops, heating hot water loops, and the building main chilled water loop. The type and manufacturer of the proposed coupon racks to be installed shall be approved by the Judicial Council. The minimum quantity of coupons and frequency of inspections shall be described in the water treatment plan. Molybdenum shall not be used in Judicial Council buildings.
- c. At a minimum, two coupon racks shall be installed for each loop and used to monitor mild steel and copper.
- d. The methods used to treat the system makeup water shall have prior success in existing facilities on the same municipal water supply and follow the guidelines outlined in *ASHRAE Handbook—HVAC Applications*. The use of nonchemical water treatment is not permitted.

13.D MECHANICAL REQUIREMENTS FOR SPECIFIC SPACES

1. General Requirements

- a. For security equipment, see chapter 4, Courthouse Security. For telecommunications equipment rooms, see chapter 17, Network and Communication Systems.
- b. Holding areas shall be negatively pressurized with regard to adjacent spaces and exhausted directly outdoors.

DIVISION TWO: TECHNICAL CRITERIA

11 Architectural Criteria

12 Structural Criteria

13 MECHANICAL CRITERIA

13.A Objectives

13.B HVAC Criteria

13.C Humidification and
Water Treatment

13.D Mechanical Requirements
for Specific Spaces

13.E Plumbing and Piping
Systems Criteria

13.F Insulation

13.G Thermometers and
Gauges

14 Building Management
System Criteria

15 Electrical Criteria

16 Lighting Criteria

17 Network and
Communication Systems

18 Audiovisual Systems

19 Acoustical Criteria

20 Fire Protection Criteria

Configure mechanical rooms with clear circulation aisles and adequate access to all equipment. The mechanical rooms shall have adequate doorways or areaways and staging areas to permit the replacement and removal of equipment without the need to demolish walls or relocate other equipment.

- c. Mechanical system diffusers and grilles in public and staff areas must be secure from tampering, particularly in areas that provide some degree of seclusion and privacy (restrooms, attorney-client visitation rooms, etc.). Maximum-security detention-type grilles, secured with tamper-proof fasteners, must be provided at all areas accessible to prisoners.
- d. If required by the risk assessment, mailrooms shall be provided with once-through air that is 100 percent exhausted from the facility. Mailrooms shall be maintained under a negative-pressure condition relative to surrounding spaces.
- e. Water lines shall not be located directly above motor control centers, panels, or disconnect switches, as required by code. The mechanical rooms shall have sloped floors with floor drains in proximity to the equipment served.
- f. No water lines are permitted in the ceiling or overhead in electrical rooms, except for fire sprinkler piping protecting the room or chilled water and condenser water piping serving the dedicated cooling equipment in the room.
- g. No water lines are permitted in the ceiling or overhead in communication rooms. See chapter 20, section 20.B.11.
- h. For elevator machine rooms, a dedicated cooling or ventilating system must be provided to maintain elevator machine room temperature as required by geographical location.
- i. For emergency generator rooms, the environmental systems shall meet the requirements of NFPA 110 (Standard for Emergency and Standby Power Systems) and the combustion air requirements of the equipment to remove heat gain from equipment operation. The air supply and exhaust shall be located so that air does not get contaminated. Refer to chapter 15, Electrical Criteria, for generator requirements.
- j. For UPS-designated battery rooms, design space to accommodate battery and exhaust requirements per code.
- k. The entrances and exits at loading docks and service entrances shall be designed to reduce infiltration and collection of outside debris. Loading docks must be maintained at negative pressure relative to the rest of the building. Enclosed vehicle sally ports shall be ventilated to prevent buildup of engine exhaust fumes and transferring of fumes into the building. Sally ports shall be equipped with ventilation fans controlled by a carbon monoxide detection and control system to automatically purge the sally port when unsafe levels of carbon monoxide are detected. The carbon monoxide sensors shall be uniformly located throughout the enclosed space and near each stairwell or exit. They shall be certified by the manufacturer to be accurate within ± 5 percent of measurement, factory calibrated; to drift no more than 5 percent per year; and to require calibration no more frequently than once a year.
- l. Toilets shall have dedicated exhaust systems.
- m. Janitor and housekeeping closets shall maintain negative pressure in the rooms relative to the surrounding spaces.
- n. All copy areas shall have a localized exhaust adjacent to high-volume reproduction machinery and shall be negative in pressure to the surrounding areas.

2. Criteria for Mechanical Spaces

Service access shall be provided for equipment per manufacturer's recommendations. Access doors or panels shall be readily operable and sized to allow full access. Access doors and panels in courtrooms must be positioned so as not to impede judicial proceedings. Make provisions for removing and replacing major equipment over the life of the building, without

damage to the structure. Provide adequate access to all devices with maintenance service requirements. Provide pathways for all major equipment that cannot be maintained from floor level.

Specifically regarding housekeeping pads, they shall be at least 6" wider on all sides than the equipment they support and a minimum height of 3-1/2" above the roof level or finished floor. The pad shall be of adequate height to trap and drain condensate from heat transfer coils to the condensate drain.

13.E PLUMBING AND PIPING SYSTEMS CRITERIA

1. Pump Systems and Hydronic Heating Water

- a. Each terminal unit or coil shall be provided with isolation valves, on both supply and return lines, and a flow-indicating balance valve on the return line. Isolation valves shall be provided on all major pipe branches, such as at each floor level, building wing, or mechanical room. Each pumping system shall be provided with a standby pump and shall be configured for automatic lead/standby operation.
- b. Each boiler shall be provided with a control and piping arrangement that protects the boiler from thermal shock.
- c. Hydronic hot water space heating pumps shall be selected to operate at 1,750 rpm maximum peak efficiency. Pumps with speeds greater than or equal to 3,500 rpm shall not be selected unless project noise criteria are proven to be met with them running at high speed.
- d. Variable-volume pumping systems shall be provided for all secondary piping systems with pump horsepower (HP) greater than 5 HP.
- e. Air separators and vents must be provided on hot water systems to remove accumulated air within the system. Automatic bleed valves shall be used only in accessible spaces in mechanical rooms where they can be observed by maintenance personnel, and they must be piped directly to open drains.
- f. Manual bleed valves shall be used at terminal units and coils. Likewise, system drains shall be provided at the main system low points of the heating system and at each heating coil.

2. Piping Systems

All piping systems shall be designed and sized in accordance with *ASHRAE Handbook—Fundamentals* and *ASHRAE Handbook—HVAC Systems and Equipment*.

- a. Materials acceptable for piping systems are black steel and copper.
- b. Stainless steel is an acceptable material for domestic water lines 6" and larger. Connection points where the stainless steel connects to piping or fittings composed of other metals shall have dielectric corrosion protection.
- c. Press-connect fittings such as ProPress or the equivalent may be used, as long as they meet all other applicable code and standards requirements. When using such fittings, they shall be installed per the manufacturer's instructions, including cutting the pipe square and chamfered and fully inserting it into the fitting before pressing occurs.
- d. No polyvinyl chloride (PVC), cross-linked polyethylene (PEX), or other types of plastic pipe are permitted within the building.
- e. Low-loss design principles shall be followed.

DIVISION TWO: TECHNICAL CRITERIA

11 Architectural Criteria

12 Structural Criteria

13 MECHANICAL CRITERIA

13.A Objectives

13.B HVAC Criteria

13.C Humidification and
Water Treatment

13.D Mechanical Requirements
for Specific Spaces

13.E Plumbing and Piping
Systems Criteria

13.F Insulation

13.G Thermometers and
Gauges

14 Building Management
System Criteria

15 Electrical Criteria

16 Lighting Criteria

17 Network and
Communication Systems

18 Audiovisual Systems

19 Acoustical Criteria

20 Fire Protection Criteria

3. Piping Accessories

3.1 Isolation of Piping at Equipment

Isolation valves, shutoff valves, bypass circuits, flanges, and unions shall be provided as necessary for piping at equipment to facilitate equipment repair and replacement. Equipment requiring isolation includes boilers, chillers, pumps, coils, terminal units, and heat exchangers. Valves shall also be provided for zones off vertical risers.

3.2 Piping System and Equipment Identification

All pipes, valves, and equipment in mechanical rooms, shafts, ceilings, and other spaces accessible to maintenance personnel must be identified with color-coded bands and permanent tags indicating the system type and direction of flow for piping systems or type and number for equipment per ANSI color and labeling standards and the plumbing code.

Gas piping and sprinkler lines must be identified as prescribed by the fire code.

4. Domestic Water Supply Systems

Water hammer arrestors shall be provided per Standard PDI-WH-201 (Plumbing Drainage Institute, Water Hammer Arrestor) at every branch to multiple fixtures and on every floor for both hot and cold water. All plumbing fixtures and equipment that supply water pressure should be below the 80 psi maximum threshold per California Plumbing Code allowance (CPC § 608.2), unless provided with a pressure-reducing device.

4.1 Cold Water Service

A pressurized piping distribution system shall incorporate a separate supply line from the tap in the existing outside water main to the equipment area inside the building. The water meters furnished by the local department of public works shall meter water service inside the facility property boundaries. Incoming service shall have an approved backflow prevention device as required by code. The irrigation systems must be submetered for deduct billing of the sewer system.

The internal distribution system shall include equipment that is capable of maintaining adequate pressure and flow in all parts of the system in accordance with the plumbing code. A booster pumping system with N+1 standby capacity shall be used if the water pressure is inadequate to provide sufficient pressure at the most remote and/or highest fixture. The water pressure at the fixture shall be in accordance with the plumbing code.

4.2 Hot Water Service

Heaters using natural gas, electricity, or steam as an energy source shall generate hot water. Selection shall be supported by an economic evaluation incorporating first cost, operating costs, and life cycle costs in conjunction with HVAC energy provisions. Domestic hot water supply shall be generated at 140°F and shall be capable of providing tempered water to at least 121°F using a three-way mixing valve, before supplying to all plumbing fixtures. Heat pump water heaters shall be used where possible to save energy. Circulation systems or temperature maintenance systems shall be included. Hot water shall be available at the farthest fixture from the heating source within 30 seconds of the time of operation. Where a hot water recirculation or electric resistance heat trace wire system is installed, the branch from the recirculating loop or electric resistance heat trace wire to the fixture should not exceed 25 feet in length per the California Plumbing Code.

The application of point-of-use instantaneous hot water generators is permitted for isolated or incidental use at terminal fixtures and single-accommodation toilet rooms.

5. Sanitary Waste and Vent Systems

5.1 Waste Pipe and Fittings

A complete sanitary collection system shall be provided for all plumbing fixtures, floor drains, and kitchen equipment designed in compliance with applicable codes and standards. Piping shall be cast iron soil pipe with hub and spigot or heavy-duty no-hub joints and fittings. Coordinate drain size with fire protection design (chapter 20, Fire Protection Criteria) so full-flow drainage is provided. Gravity-drained waste piping shall slope at no less than 1/4" per foot of run unless approved by the authority having jurisdiction because of site conditions.

5.2 Floor Drains

Floor drains shall be provided in all toilet rooms, mechanical equipment rooms, locations where condensate from equipment collects, locations where emergency showers or eyewashes drain to the floor, and parking garages and ramps. Condensate piping shall be routed as required by the plumbing code. See chapter 8, section 8.E.8 for more information regarding floor drains in holding areas. In general, floor drains shall have a cast iron body type with 6" diameter stainless steel strainers for public toilets, kitchen areas, and other public areas. Provide vandal-proof fasteners for floor drains where there is public access. Equipment room areas shall require large diameter cast iron strainers, and parking garages shall require large diameter tractor grates.

Drainage for ramps shall require either trench drains or roadway inlets when exposed to rainfall and connect only to the storm drainage system, unless otherwise required on a site-specific basis. Storm drainage and sanitary sewer drainage systems should be drained separately as required by the California Plumbing Code. An automatic trap primer system shall be provided for P traps, as required by the California Plumbing Code. Power for trap primers shall include a disconnect switch. Trap guards that are International Association of Plumbing and Mechanical Officials (IAPMO) listed per the plumbing code are also an acceptable means for trap protection.

5.3 Sanitary Waste Equipment

Specific drains in kitchen areas (not employee break rooms) shall discharge into a grease interceptor before connecting into the sanitary sewer in accordance with the requirements of the state health department and local authorities. Sinks with garbage disposals may not discharge into a grease interceptor. If a sink produces grease waste, it shall not have a garbage disposal. Floor drains or trench drains in garage locations are to discharge into sand/oil interceptors, as required by the plumbing code.

5.4 Automatic Sewage Ejectors

Sewage ejectors shall be used only where gravity drainage is not possible. If sewage ejectors are required, only the lowest floors of the building shall be connected to them; fixtures on upper floors shall use gravity flow to the public sewer. Sewage ejectors shall be nonclog, screenless duplex pumps, with each discharge not less than 4" in diameter. They shall be connected to the emergency power system, if available.

DIVISION TWO: TECHNICAL CRITERIA

11 Architectural Criteria

12 Structural Criteria

13 MECHANICAL CRITERIA

13.A Objectives

13.B HVAC Criteria

13.C Humidification and Water Treatment

13.D Mechanical Requirements for Specific Spaces

13.E Plumbing and Piping Systems Criteria

13.F Insulation

13.G Thermometers and Gauges

14 Building Management System Criteria

15 Electrical Criteria

16 Lighting Criteria

17 Network and Communication Systems

18 Audiovisual Systems

19 Acoustical Criteria

20 Fire Protection Criteria

All insulation shall comply with fire and smoke hazard ratings indicated by ASTM Standard E84, the NFPA, and UL. Accessories such as adhesives, mastics, cements, and tapes shall have the same or better component ratings.

5.5 Rainwater Drainage System

Pipes and fittings shall be in compliance with local codes and sized based on local rainfall intensity. Roof drains shall be cast iron body type with high dome grates and membrane clamping rings that are manufactured as part of the assembly. Each roof drain shall have a separate overflow drain located adjacent to it. Overflow drains shall be the same drains as the roof drains except with a damming weir extension. Overflow drains shall route to discharge in an obvious location.

5.6 Plumbing Fixtures

All plumbing fixtures and faucets shall be WaterSense labeled or equal, commercial-grade type, similar to hotel-type fixtures. Provide automatic flush valves for urinals and water closets and automatic faucets in public toilet rooms. Sensors shall be self-powered hydroelectric type or have minimum three-year battery operation life. For detention fixtures, see chapter 8, In-Custody Defendant Receiving, Holding, and Transport. Water closet carriers that are 500-pound-rated shall be provided for all wall-mounted water closets. Floor-mounted carriers shall be provided for all wall-mounted urinals and lavatories. A hose bibb shall be provided in each multifixture restroom.

5.7 Leak Detection System

A leak detection system shall be considered for the plumbing and hydronic systems based on available technology and cost-effectiveness.

5.8 Commissioning

Commissioning of all water systems shall be done per chapter 14, Building Management System Criteria.

6. Fuel Piping

6.1 Natural and Propane Gas Systems

a. Service entrance: Gas piping entering the building must be protected from accidental damage by vehicles, foundation settlement, or vibration. Where practical, the entrance shall be above grade and provided with a self-tightening swing joint before gas pipe enters the building. The provision of a seismic gas shutoff valve is not required for facilities that conform to the following provisions of the building and fire codes:

- The building structure is classified as a one-hour rated classification.
- The building has an approved and operational fire sprinkler system.

b. Gas shall not be piped through confined spaces, such as trenches or unventilated shafts. All spaces containing equipment such as gas-fired boilers, chillers, and generators shall be ventilated. Vertical shafts carrying gas piping shall be ventilated. Gas meters shall be located in enclosed rooms that comply with local utility regulations.

6.2 Fuel Oil Systems

a. Fuel oil-piping systems shall use at least schedule 40 black steel or black iron piping. Fittings shall be of the same grade as the pipe material. Valves shall be bronze, steel, or iron and may be screwed, welded, flanged, or grooved. Double-wall piping with a leak detection system shall be used for buried fuel piping. Duplex fuel oil pumps with basket strainers and exterior enclosures shall be used for pumping the oil to the fuel-burning equipment.

b. No underground fuel oil storage tanks shall be installed in a courthouse

facility. Aboveground storage tanks shall be installed at ground level or higher whenever possible. The location of the storage tank’s fuel delivery port shall provide a safe, protected location for fuel delivery vehicles to park and exit. The parking and work area for fuel deliveries shall have a concrete surface.

- c. The fuel storage capacity of each generator system shall be determined by the emergency response plan requirements. Coordinate the fuel storage capacities with the requirements described in chapter 15, Electrical Criteria. The location of the generator system exhaust discharge shall be selected to minimize the potential of entrainment of exhaust fumes into the outside air intakes. Any additional external fuel tanks for the generator system shall be located adjacent to the generator in compliance with current and applicable fire code and UL listings for double containment tanks.

13.F INSULATION

1. Piping Insulation

Insulation shall be provided on all piping systems in accordance with the California Energy Code or where condensation has the potential of forming. Insulation that is subject to damage or reduction in thermal resistivity if wetted shall be enclosed with a vapor seal (such as a vapor barrier jacket).

Insulation shall have zero permeability. All exposed piping up to 8’ above finished floor shall have PVC jacketing. All insulated piping exposed to the weather shall be protected with aluminum jacketing and seams sealed.

2. Duct Insulation

Insulation shall be provided on all duct systems in accordance with the California Energy Code. All duct insulation materials used as internal insulation exposed to the airstream shall be in accordance with UL 181 or ASTM C1071 erosion tests. The materials shall not promote or support the growth of fungi or bacteria. All exposed, externally insulated ductwork shall have sealed jacketing equal to Alumaguard. All concealed, externally insulated ductwork shall have foil face jacketing. Supply air duct insulation shall have a vapor barrier jacket. The insulation shall cover the duct system with a continuous, unbroken vapor seal. Insulation shall have zero permeability.

All return air and exhaust air distribution systems shall be insulated if required by the California Energy Code. The insulation of return air and exhaust air distribution systems shall be evaluated for each project and for each system to guard against condensation formation and heat gain or loss on a recirculating or heat-recovery system, and for acoustics.

3. Equipment Insulation

All equipment—including air-handling units, chilled and hot water pumps, and heat exchangers—must be insulated in accordance with the California Energy Code.

4. Thermal Pipe Insulation for Plumbing Systems

Insulate all sanitary sewer vents terminating through the roof, if outdoor conditions justify, to prevent condensation from forming. Include a vapor barrier jacket on this insulation. All horizontal storm water piping shall be insulated from the drain body to the vertical drop, as required, to prevent condensation.

DIVISION TWO: TECHNICAL CRITERIA

11 Architectural Criteria

12 Structural Criteria

13 MECHANICAL CRITERIA

13.A Objectives

13.B HVAC Criteria

13.C Humidification and Water Treatment

13.D Mechanical Requirements for Specific Spaces

13.E Plumbing and Piping Systems Criteria

13.F Insulation

13.G Thermometers and Gauges

14 Building Management System Criteria

15 Electrical Criteria

16 Lighting Criteria

17 Network and Communication Systems

18 Audiovisual Systems

19 Acoustical Criteria

20 Fire Protection Criteria

Btu = British thermal unit

Cal/OSHA = Division of Occupational Safety and Health

CSA = Canadian Standards Association.

dBA = decibels

EMT = electrical metallic tubing

EPDM = ethylene propylene diene monomer

fpm = feet per minute

ft² = square feet

hr = hour

ID = inside diameter

MERV = minimum efficiency reporting value

TBD = to be determined

TEFC = totally enclosed, fan cooled

VFD = variable-frequency drive

VSD = variable-speed drive

WC = water column

13.G THERMOMETERS AND GAUGES

Major mechanical equipment shall be provided with instrumentation that includes Instrument Society of America (ISA) data sheets and permanent test ports to verify critical parameters, such as capacity, pressures, temperatures, and flow rates. Following are the general instrumentation requirements:

- Thermometers and pressure gauges are required on the suction and discharge of all pumps, chillers, boilers, heat exchangers, cooling coils, heating coils, and cooling towers.
- To avoid pressure gauge tolerance errors, a single pressure gauge may be installed, with a valve to sense both supply and return conditions.
- For coils with flows of less than 10 gallons per minute, provide permanent provisions for use of portable instruments to check temperatures and pressures.
- Differential static pressure gauge assemblies shall be placed across filters in air-handling units.

1. Airflow Measuring Devices

Airflow measuring grids are required for all outside air systems. Airflow measuring grids must be sized to give accurate readings at minimum flow.

2. Water Flow Measuring Devices

Water flow or energy measuring devices shall be required for each chilled water refrigeration machine, hot water boiler, and pump, as well as connections to district energy plants. Individual water flow or energy-measuring devices shall be provided for chilled water lines serving computer rooms and chilled water and hot water lines to leased spaces. Flow measuring devices shall be capable of communicating with the BMS, and trending shall be enabled per chapter 14, Building Management System Criteria. Water flow and airflow measuring devices shall confirm or validate California Energy Code and ASHRAE Standard 90.1 requirements before occupancy.

Table 13.3 AHU Matrix (Airflow Ranges >5,000 to <60,000 cfm)

AHU COMPONENT ITEMS	MINIMUM REQUIREMENTS
Filters	ASHRAE 52.2, rigid or bag filters, MERV 13, low-pressure drop, rated at 500 fpm: 0.08" WC clean, 1.0" WC dirty, >150 grams minimum dirt holding capacity
Prefilter Frames	Front- or side-loading type: galvanized steel construction, incorporating closed-cell gasket edge with permanently attached 316 stainless steel hinged or locking clips that interlock with filter header, <5% bypass leakage at 2" of static pressure
Filter Media Gaskets	Closed-cell neoprene or EPDM gasket, bonded to filter track header
Outside Air Makeup Dampers	Low-leakage control dampers
Preheat Coils (optional; to be determined [TBD])	Copper tube / copper fins; >0.049"/0.010" >6 fins/inch
Preheat Coil Drain Pan (optional; TBD)	Stainless steel 304, double sloped—no-standing-water design, >1/4"/ft minimum slope, 16-gauge construction or approved equal
Steam Humidifier Section (optional; TBD)	Stainless steel 304 grid type (DriSteem, UltraSorb, or approved equal)
Supply and/or Return Fan Systems	TBD by engineer
Supply Fan Motors: Inverter Duty Motors	Motor shaft grounding protection; this requirement is to increase the service life of the motor-associated VFDs
Supply Fan Type	Aluminum, steel, or composite airfoil type, AMCA certified—continuous welded scroll section, no bolts or screws protruding into the air stream
Fan Wheel Protection	Cal/OSHA General Industry Safety Orders, California Code of Regulations, title 8, section 3995 et seq. (Article 41, Prime Movers and Machinery)
Fan Isolation (vertical/horizontal)	>2" spring height with seismic rated captive housing
Cooling Coils Tubes	Copper tubes ≥5/8" diameter, 0.020" min. tube wall
Cooling Coil Fins	Aluminum fins (min. 0.008"), coastal locations to use copper fins: maximum of 10 fins/inch
Coil Casing	Stainless steel 304 construction
Coil Access	Field cleanable and side access removable without cutting and welding
Cooling Coil Drain Pan	Stainless steel 304, 18-gauge construction, double-sloped—no-standing-water design, >1/5"/foot minimum slope, pan extends at >1" downstream and >1" upstream of the coil face sections or approved equal
AHU Casing: Double-Wall Construction, Internal Wall Insulation, Solid Smooth Interior, Wipe-Down and Cleanable Surfaces	Aluminum or galvanized steel; manufacturer shall provide calculations certifying that internal insulation meets or exceeds a 0.0769 Btu/hr/ft ² /F; double-walled, thermal break construction with closed-cell polyurethane foam or mineral wool insulation and no exterior and interior caulked seams
AHU Door Access	Lockable doors
AHU Door Gaskets	Closed-cell neoprene or interlocking EPDM gaskets embedded along the entire door assembly

**DIVISION TWO:
TECHNICAL CRITERIA**

11 Architectural Criteria

12 Structural Criteria

13 MECHANICAL CRITERIA

13.A Objectives

13.B HVAC Criteria

13.C Humidification and Water Treatment

13.D Mechanical Requirements for Specific Spaces

13.E Plumbing and Piping Systems Criteria

13.F Insulation

13.G Thermometers and Gauges

14 Building Management System Criteria

15 Electrical Criteria

16 Lighting Criteria

17 Network and Communication Systems

18 Audiovisual Systems

19 Acoustical Criteria

20 Fire Protection Criteria

Table 13.3 continues on next page

Table 13.3 AHU Matrix (Airflow Ranges >5,000 to <60,000 cfm) *continued*

AHU COMPONENT ITEMS	MINIMUM REQUIREMENTS
AHU Flooring (1/8" minimum thickness); the design shall prevent floor "oil canning" with 200-pound single-point load over 1 square foot area	Aluminum with aluminum casing or galvanized steel with galvanized steel casing
AHU Interior Lighting	Interior light fixture, NEMA 3R housing with exterior-mounted control switch
Supply Fan Motors (TEFC) (1,200–1,800 rpm)	Label for inverter duty, high-efficiency, TEFC <2 HP, premium high-efficiency, TEFC >3 HP with sealed grease bearings
Fan Access for >20 HP Motors	Overhead support beam to allow for the removal of motor and fan assemblies
AHU Door Access	Each section—double-gasket closed-cell neoprene
AHU Under Floor Insulation	Equal to U-factor of walls
AHU Minimum Frame Rail Height	>3" height, vertical flange-to-flange edges
AHU Frame Deflection	>1/240 of overall length
Cooling Coil Velocity (design)	<475 fpm
Filter Face Velocity (design)	<475 fpm
AHU Casing Leakage	≤1.5% of total design air flow
Smoke Detector	UL/CSA-listed (low-velocity type 200–650 fpm)
AHU Test Ports	1/2" ID port with threaded cap for each access door
AHU Variable-Speed Drive (VSD) Inverter	Any of the following: Yaskawa, Danfoss, or ABB only with integral bypass assembly or approved equal
AHU Drain Pan Void Insulation	Expanded foam type or approved equal
AHU Underfloor Insulation	Compressed fiber or expanded foam type or approved equal
AHU Bottom Plate	TBD by engineer
Seismic Design (California)	Zone TBD, C-Factor >TBD
AHU Airfoil Dampers	Low-leakage type with shaft seals
AHU Coil Piping	Gasketed casing penetrations with identification labels
AHU Cooling Drain Pan Piping	Piped and sloped to exterior for connection
AHU Coil Section Drain Piping	Floor drain capped and pipe and slope to exterior with thread cap
AHU Sound Criteria (at 1 meter)	<75 A-weighted decibels (dBA) ±3
Electrical Services	TBD, 3 phase; 120 volts, 1 phase
Electrical Conduits	EMT or PVC
Electrical Safety	Manual disconnect and emergency stop button per NEC
Electrical Controls	Color-coded and numbered wiring between electrical components at designated interconnections for testing and factory commissioning (refer to chapter 14, Building Management System Criteria, for sample sensor list)

Table 13.3 continues on next page

Table 13.3 AHU Matrix (Airflow Ranges >5,000 to <60,000 cfm) continued

AHU COMPONENT ITEMS	MINIMUM REQUIREMENTS
Warranty	18 months from date of shipment from factory; 12 months from startup; 8 months from completion of onsite acceptance testing
Factory Cleaning and Packaging for Shipping	Surface wipe-down of interior, vacuum clean interior, provide protection of openings, exterior shrink-wrap for shipping, dedicated trucking to the jobsite

Notes:

Btu = British thermal unit.

Cal/OSHA = Division of Occupational Safety and Health.

CSA = Canadian Standards Association.

dBa = decibels.

EMT = electrical metallic tubing.

EPDM = ethylene propylene diene monomer.

fpm = feet per minute.

ft² = square feet.

hr = hour.

ID = inside diameter.

MERV = minimum efficiency reporting value.

TBD = to be determined.

TEFC = totally enclosed, fan cooled.

VFD = variable-frequency drive.

VSD = variable-speed drive.

WC = water column.

DRAFT

**DIVISION TWO:
TECHNICAL CRITERIA**

- 11 Architectural Criteria
- 12 Structural Criteria

13 MECHANICAL CRITERIA

- 13.A Objectives
- 13.B HVAC Criteria
- 13.C Humidification and Water Treatment
- 13.D Mechanical Requirements for Specific Spaces
- 13.E Plumbing and Piping Systems Criteria
- 13.F Insulation
- 13.G Thermometers and Gauges

- 14 Building Management System Criteria
- 15 Electrical Criteria
- 16 Lighting Criteria
- 17 Network and Communication Systems
- 18 Audiovisual Systems
- 19 Acoustical Criteria
- 20 Fire Protection Criteria

DRAFT

DIVISION TWO: TECHNICAL CRITERIA

14

BUILDING MANAGEMENT SYSTEM CRITERIA

SECTION	TOPIC	PAGE
14.A	Objectives	14.2
14.B	Building Management System	14.2
14.C	Level of Integration	14.4
14.D	Energy Conservation Design	14.4
14.E	Design Features	14.6
14.F	Commissioning	14.6



The criteria as outlined in this chapter shall be used in designing and selecting the building management system.

See chapter 17, Network and Communication Systems, for requirements to develop a technology program for each court building project.

The building management system device protocols and software will provide the following functions:

- Data collection
- Data archiving
- Data trending
- Calendar scheduling
- Programming and adjustment of system-functional set points
- Automatic and manual control of addressable field devices
- Access to building system flow diagrams, with navigation using graphical user interface (GUI)
- Energy management monitoring and curtailment
- Password reset
- Alarm-level notification

14.A OBJECTIVES

This section identifies the criteria for systems that provide integrated control, monitoring, and communication of the heating, ventilation, and air-conditioning (HVAC) and plumbing systems within a court facility. The objectives of building automation are improved occupant comfort, efficient operation of building systems, reduction in energy consumption and operating costs, and improved life cycle of utilities.

The means and content of information to be reported remotely shall be discussed with the Judicial Council and the project team. For detailed Judicial Council requirements for the building management system (BMS), see tool 6, Building Management System Guidelines.

14.B BUILDING MANAGEMENT SYSTEM

1. General Requirements

- a. The BMS shall be designed to automatically respond to local climatic conditions and energy-efficiency opportunities by providing cost-effective energy conservation measures (ECMs) while ensuring set point control.
- b. A new control system shall be nonproprietary for interoperability (meaning the ability of disparate control system devices to work together through the digital exchange of relevant information). The system will allow third-party protocol acceptance and processing of inputs from devices supplied by different vendors.
- c. The BMS depends on local area support. Consult with the Judicial Council before determining the allowable manufacturers for each project site.

2. Minimum BMS Requirements

- a. The facility local area network and device level network shall be based on industry-standard open platforms and use commonly available operation, management, and application software. All software packages and databases shall be licensed to the Judicial Council of California to allow unrestricted maintenance and operation of the BMS.
- b. The BMS system shall use the local area network (LAN), building-provided network switches, and infrastructure. All devices requiring a network connection shall be identified and added to the “Network Port Count Matrix.” A temporary network can be used to commission the system until the building network is active and connections can be transferred to the building infrastructure.
- c. All communication products shall have a BTL (BACnet Testing Laboratories) mark certifying that the product was independently tested by a third-party testing facility and complied with Building Automation and Control Network (BACnet) conformance requirements.
- d. Except for field-mounted instrumentation and devices, all BMS components shall be installed in field panels also known as temperature control panels (TCPs). Panels and enclosures shall be located only within mechanical rooms or at approved locations.
- e. Coordinate with the electrical engineer to provide power supply sources of 120 volts of alternating current to all BMS field panel locations. The selection of normal power supply or standby power supply facilities shall be based on project- and application-specific requirements. In general, BMS panels monitoring designated building-critical alarm points shall be provided with standby power supplies. Where no standby power is available in the building, the tie-in panel shall be provided with a local uninterruptible power supply.

- f. The BMS shall incorporate hardware and software resources sufficient to meet the functional requirements of the specifications.
- g. BMS installation shall use standardized iconography as part of the graphical user interface (GUI). These graphical icons shall be based on the type of equipment, must be approved by the Judicial Council at the time of system design, and shall include the following, at a minimum:
- Equipment pictorial diagrams of network component devices to provide a single-line network diagram of equipment.
 - Interactive, color-coordinated graphical status symbols
 - Component-level status notifications on demand
 - Execution of password-protected global and component-level commands
 - Multiple-level alarm notifications as defined by the user
 - Network component device fault detection and diagnosis system data and alarm collection
 - Energy and utility consumption data collection
 - Environmental data collection
 - Optional wireless communication of disparate and non-disparate systems
 - Optional seismic response data collection
- h. The BMS shall consist of a series of direct digital microprocessor controllers and have a central processing station, all interconnected by a high-speed LAN. The installation of a central processing station shall depend on building size, and this requirement shall be determined by the Judicial Council before the design proceeds.
- i. The failure of a TCP shall not affect the operation of other operating TCPs. Where information in the failed TCP is used by other TCPs, the unavailability of the information shall be alarmed, and alternative control strategies shall be automatically initiated. All required logic programming and point database facilities associated with an individual system shall reside in the same TCP to which the system input/output points are terminated.
- j. All nonproprietary energy management software and firmware shall be resident in field hardware and shall not depend on the operator's central control system terminal. Therefore, if the central control system fails, local control devices will continue to operate at the last control set point.
- k. The BAS network shall consist of an independent Ethernet ring network topology support to provide a means for the IP DDC (Internet Protocol direct digital control) controllers to continue to communicate, even if one controller or network segment within the ring network stops communicating, providing network reliability by mitigating a single point of failure in the IP/Ethernet network wiring. Refer to chapter 17, Network and Communication Systems, which discusses integrated network architecture to provide a common backbone platform for the integration of multiple systems. The control system design shall include a cabling network that complies with Telecommunications Industry Association's TIA-862, Structured Cabling Infrastructure Standard for Intelligent Building Systems. The LAN shall be Institute of Electrical and Electronics Engineers' IEEE 802.3 Standard for Ethernet over fiber or Category 6 cable with switches and routers that support 1000BASE-T gigabit Ethernet throughput.

**DIVISION TWO:
TECHNICAL CRITERIA**

- 11 Architectural Criteria
- 12 Structural Criteria
- 13 Mechanical Criteria

**14 BUILDING MANAGEMENT
SYSTEM CRITERIA**

- 14.A Objectives
- 14.B Building Management System
- 14.C Level of Integration
- 14.D Energy Conservation Design
- 14.E Design Features
- 14.F Commissioning

- 15 Electrical Criteria
- 16 Lighting Criteria
- 17 Network and Communication Systems
- 18 Audiovisual Systems
- 19 Acoustical Criteria
- 20 Fire Protection Criteria

- l. A remote or local user, with proper username and password, shall have access to monitor or control the BMS functions via a graphical interface. Native internet browser-based user interfaces must be HTML (hypertext markup language) compliant and not require plug-ins (thin clients). The system shall be capable of supporting an unlimited number of clients using a standard secure Web browser.

14.C LEVEL OF INTEGRATION

- a. The building management system shall not control the fire alarm, security, lighting, or court business systems. These systems shall have independent control panels and network interfaces. The BMS shall, however, be able to monitor the status of these systems, as required, in order to prompt emergency operating modes of the HVAC system.
- b. The control system shall be designed to use the available energy efficiently and to assist in troubleshooting the malfunction conditions of numerous addressable and non-addressable devices.
- c. The programming of the control system shall be performed from the facility operation center or remotely via a Web browser. Provide a field processing unit or Web server to access the system via a Web browser. Both require a password for access, and the latter shall have firewall protection.
- d. Ensure that installed BMSs comply with the American Society of Heating, Refrigerating and Air-Conditioning Engineers' ASHRAE Standard 135-2020, introducing BACnet/SC (Secure Connect), and the National Institute of Standards and Technology (NIST) Cybersecurity Framework.
- e. The system must include the ability to log data created by user-selectable features.
- f. The BMS shall have at least 25 percent spare memory capacity for future expansion.
- g. All new systems shall be native protocol neutral and shall use no gateways for communication with controllers.

14.D ENERGY CONSERVATION DESIGN

ASHRAE Guideline 36, High-Performance Sequences of Operation for HVAC Systems, shall be used when developing building-specific sequences of operations (SOOs). The HVAC control algorithms shall include optimized environmentally linked start/stop for equipment and shall be in accordance with the project's associated energy goals and the current California Energy Code, at a minimum. Commissioning of the SOOs on all applicable systems shall be done before building occupancy and follow LEED post-occupancy commissioning procedures.

The HVAC building control system shall have the capability to perform automatic measurement of energy consumption and to monitor performance as described in this section.

1. Energy Measurement and Demand-Response Capabilities

The HVAC building control system shall have the capability to perform automatic measurement of total energy consumption. The BMS shall have demand-response capabilities as stipulated by the California Building Code and discussed below.

- a. The BMS shall be capable of interacting with HVAC equipment to demand-limit individual cooling equipment (e.g., chiller demand limiting).
- b. Automatically adjust temperature set point by ± 4 degrees Fahrenheit in noncritical zones from a central point as necessary to demand-limit the HVAC system on receipt of a signal from the local utility provider.

- c. Return the system to its original state following a demand-response event.
- d. Provide an adjustable rate of change, and provide three operating states: Automated Demand Shed, Manual, and Disabled.
- e. Through zone-level sequences of operations, courtrooms, holding cells, and judges' chambers shall be excluded from being affected during demand-response events.

2. Energy Management via Trending

Analytics are an important element in managing the efficiency of building systems. Therefore, the following are required as part of the BMS.

- a. Electrical values such as volt (V), ampere (A), and kilowatt (kW) shall be monitored at equipment with motors.
- b. Mechanical values such as chilled water flow, temperature, and pressure; hot water flow, temperature, and pressure; equipment status; and equipment capacity shall be monitored, measured, and stored. These points shall be gathered from connected equipment, as applicable (e.g., chiller reported values), or meters, as applicable (e.g., BTU meters).
- c. All control points monitored and controlled via the system shall be archived in the local microprocessor controllers and set up to frequently be archived into the central processing station (e.g., front end) for indefinite historic data retrieval, with points naming conventions that incorporate Project Haystack data tagging (as incorporated at time of writing in proposed ASHRAE Standard 223P, Designation and Classification of Semantic Tags for Building Data).
- d. Energy management measurements shall have the capability to mark trends in both instantaneous (e.g., kW) and time-based (e.g., kWh) numbers for chillers, boilers, air-handling units, exhaust fans, and pumps.
- e. Trending of all control points used in the SOO calculations shall be provided at 15-minute intervals. These points include but are not restricted to outside air temperature (OAT), supply air temperature (SAT), return air temperature (RAT), chilled water supply and chilled water return temperatures (CWST & CWRT). During the commissioning phase of building construction, all points within the building shall be enabled for trending. All applicable points used in commissioning of the building pre-occupancy shall be able to be adjusted to 5-minute intervals for the commissioning phase and future retro-commissioning activities. After the commissioning phase of construction is completed, trends shall be reset to 15-minute intervals for a pre-agreed-on list of points.
- f. Trended points shall be exported in a single comma-separated value formatted text file (a .csv file) and written to a shared drive at one-week intervals. The collection of data shall be maintained indefinitely and archived annually, locally, on the central control system.
- g. Trending intervals shall be easily adjustable at the front end to at least 5-minute intervals for commissioning purposes and re-enabled to 15-minute intervals thereafter. Commissioning activity trending shall be stored and labeled accordingly in the same manner as normal trending log files.
- h. Trend files shall be accessible to court staff, commissioning agents, and service providers remotely. These files shall be download-able from a remote location and through the user front-end.

DIVISION TWO: TECHNICAL CRITERIA

- 11 Architectural Criteria
- 12 Structural Criteria
- 13 Mechanical Criteria

14 BUILDING MANAGEMENT SYSTEM CRITERIA

- 14.A Objectives
- 14.B Building Management System
- 14.C Level of Integration
- 14.D Energy Conservation Design
- 14.E Design Features
- 14.F Commissioning
- 15 Electrical Criteria
- 16 Lighting Criteria
- 17 Network and Communication Systems
- 18 Audiovisual Systems
- 19 Acoustical Criteria
- 20 Fire Protection Criteria

14.E DESIGN FEATURES

Specific control features and points shall be dictated by project-specific design requirements and SOOs.

- a. The following general features shall be implemented:
 - Direct digital control drill down to zone level at the front end and remotely through a browser-based interface
 - Zone-level closed-loop temperature control
 - Fault detection and diagnostics over and above the requirements for economizers set forth in the California Building Code
 - Cascading closed loop for sequencing to minimize heating and cooling
 - Variable air volume (VAV) zone cascading control (no overlapping of heating and cooling)
 - Air-handling unit controls (cascading set point reset per ASHRAE Standard 55, where applicable)
- b. Accurate direct measurement (of, e.g., differential pressure or flow station) of minimum outside air flow at the outside air damper/plenum assembly shall be provided for all air moving equipment, as applicable. Outside airflow shall be trended by the control system at 15-minute intervals.
- c. Occupant status for control, if applicable per code, shall be coordinated and interfaced with the lighting control system to avoid a double-up on status sensors.
- d. Nighttime ventilation for the purpose of building precooling or pre- or postoccupancy air changeover shall be investigated based on historic nighttime temperature swings. As applicable, nighttime ventilation shall take place when building temperature and OAT are at suitable levels to properly cool the building before occupancy.
- e. A pre- and postoccupancy building flush control sequence shall be submitted for review during the submittal review phase. This building flush sequence of operation will accommodate three total air changes, with minimal use of building heating and cooling during utility nonpeak periods.
- f. A written mechanical control intent narrative submittal shall be provided that explains the mechanical control systems in common language, for client review and response during each design phase, and revised for submittal as part of the contract documents. Selected control manufacturers shall be required to verify that their products, as submitted during the shop drawing phase, meet the control intent, or to indicate any exceptions and describe how they intend to satisfy the desired performance of their products.

14.F COMMISSIONING

1. Commissioning is a systematic process of ensuring that all building systems perform interactively according to the design intent and the owner's operational needs. It is achieved beginning in the design phase by documenting design intent and continuing through construction, acceptance, and the warranty period with actual verification of performance. The commissioning process shall encompass and coordinate the traditionally separate functions of system documentation, equipment startup, control system calibration, testing and balancing, performance testing, and training.

2. The following commissioning (Cx) process activities shall be completed for mechanical, electrical, plumbing, and renewable energy systems and assemblies, in accordance with ASHRAE Guideline 0-2013 and ASHRAE Guideline 202-2018 for HVAC&R (HVAC and refrigeration) systems, as they relate to energy, water, indoor environmental quality, and durability.
 - a. Develop the Owner’s Project Requirements (OPR)
 - b. Develop a Basis of Design (BOD)
3. The commissioning authority (CxA) must do the following:
 - a. Review the OPR, BOD, and project design.
 - b. Develop and implement a Cx plan.
 - c. Confirm incorporation of Cx requirements into the construction documents.
 - d. Develop construction checklists.
 - e. Review contractor submittals.
 - f. Develop a system test procedure.
 - g. Verify system test execution.
 - h. Maintain an issues and benefits log throughout the Cx process.
 - i. Verify systems manual updates and delivery.
 - j. Prepare a final Cx process report.
 - k. Document all findings and recommendations, and report directly to the owner throughout the process.
4. Specifications shall include commissioning services to ensure that the building delivered at the end of construction has a fully operational building management system, mechanical control sequences, sensors, and programming, all of which provide proper controls. Basic services shall include staff training for systems operation and troubleshooting.

**DIVISION TWO:
TECHNICAL CRITERIA**

- 11 Architectural Criteria
- 12 Structural Criteria
- 13 Mechanical Criteria

**14 BUILDING MANAGEMENT
SYSTEM CRITERIA**

- 14.A Objectives
- 14.B Building Management System
- 14.C Level of Integration
- 14.D Energy Conservation Design
- 14.E Design Features
- 14.F Commissioning

- 15 Electrical Criteria
- 16 Lighting Criteria
- 17 Network and Communication Systems
- 18 Audiovisual Systems
- 19 Acoustical Criteria
- 20 Fire Protection Criteria

DRAFT

DRAFT

15

DIVISION TWO: TECHNICAL CRITERIA

ELECTRICAL CRITERIA

SECTION	TOPIC	PAGE
15.A	Objectives	15.2
15.B	Electrical Criteria	15.2
15.C	Emergency and Standby Power Systems	15.9

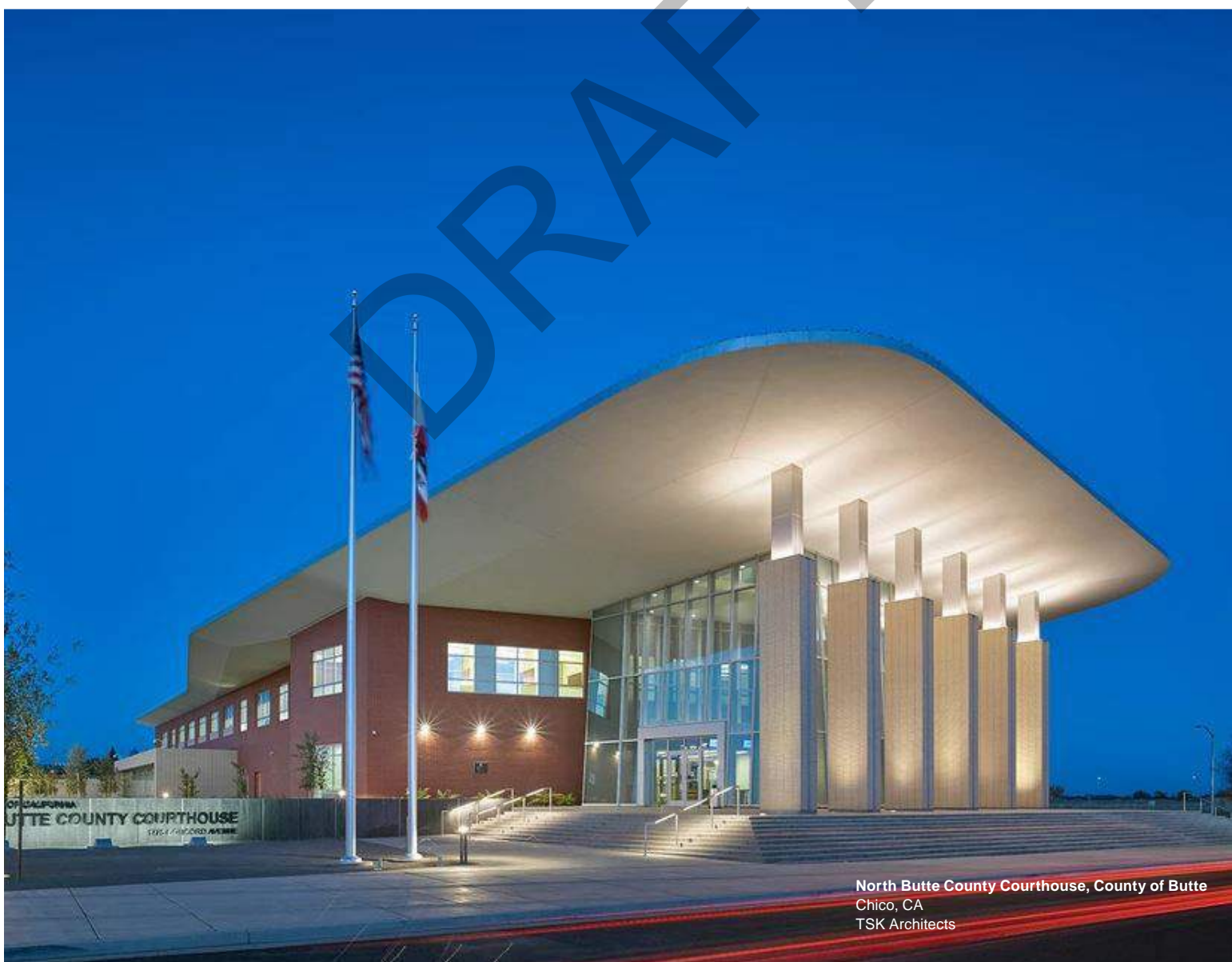

North Butte County Courthouse, County of Butte
Chico, CA
TSK Architects

Designers shall use the criteria to develop electrical power systems for new buildings, retrofit of existing buildings, and interior renovation of existing buildings.

This section defines the general and technical criteria for the building's normal power system and the emergency and standby power systems. It encompasses recommendations and minimum acceptable performance criteria for the normal power distribution system and the emergency and standby power systems.

15.A OBJECTIVES

- a. Designers shall use these criteria to develop the building's electrical power systems and emergency and standby electrical power systems, including emergency generator and uninterruptible power supply (UPS) design, and energy generation, when applicable. The electrical system design shall provide safe installation and operation of the electrical power supply and distribution through standardization of design, installation, and testing requirements, based on sound engineering principles, applicable building codes, and field experience. For renovation projects, at the schematic design phase, the designer shall identify a specific list of standards deviations that are proposed based on the existing system configurations and the extent of renovations included in the project.
- b. These criteria set the minimum acceptable requirements for design and installation of electrical power systems. Although new technologies or alternative arrangements may be used, they shall not result in a lower level of safety than prescribed by these criteria and the applicable state building codes.
- c. When the criteria are applied to interior renovations of existing structures, the designer shall provide systems that meet the design parameters of the existing power system and the requirements of these criteria, whichever result in a better system and satisfy the applicable building codes.
- d. The designer shall coordinate the requirements and configuration of the utility supply connections with the Judicial Council and the utility service providers to determine voltage, service redundancy, and other facility service criteria.
- e. Low energy use through conservation and whole-building integrated energy-efficiency measures shall be the initial focus of design. If the project includes energy generation (e.g., photovoltaic systems), consider installing energy storage and utilizing a power monitoring system to shift energy use for peak load reduction, limit overgeneration sent back to the grid, reduce the demand charges, reduce energy costs by taking advantage of time-of-use (TOU) rates, and provide cloud cover and outage protection for the facility.

15.B ELECTRICAL CRITERIA

1. Basic Requirements

- a. Electrical loads shall be determined by space classification and utilization of the following standards and requirements:
 - Title 24 of the California Code of Regulations, Leadership in Energy and Environmental Design (LEED), and Illuminating Engineering Society (IES) standards for lighting loads and levels;
 - National Fire Protection Association (NFPA) 70 National Electric Code, California Electric Code, and LEED requirements for receptacle and building general loads; and
 - Any additional requirements that may be referenced in the above-referenced standards.
- b. The lighting power densities shall not exceed the current California Energy Code.

- c. Two locations for computer receptacles shall be provided in all office spaces. Do not locate computer receptacles on wall with entrance door to the office. Provide at least one convenience receptacle in every room. Maximum number of receptacles per circuit:
 - Computer receptacles: 4
 - Convenience receptacles: 6
- d. Provide dedicated receptacles for:
 - Vending machines;
 - Microwaves;
 - Refrigerators;
 - Ice machines; and
 - Electric water coolers and bottle fillers.
- e. Provide convenience receptacle every 40' along the public corridor.
- f. Regarding spare capacity, all electrical panels, including the main building electrical service, shall be adequately sized to power all the building loads, in addition to providing the spare capacity listed in table 15.1.

Table 15.1 Spare Capacity Requirements

EQUIPMENT	SPARE LOAD CAPACITY	BREAKER SPARES	BREAKER SPACES
Main Switchboards	15%		25%
Distribution Panelboards & Motor Control Centers	15%		25%
Panelboards	20%	10%	15%

- g. The spare positions shall be complete, with full-length bus and hardware for future breaker installation. The designer shall demonstrate at the turnover of 100 percent of the construction documents that the required spare capacity and spaces have been preserved. The spare capacity shall also be provided at each of the following system elements:
 - Distribution transformers
 - Standby and emergency power systems
 - UPS systems
 - Distribution bus risers
 - Distribution feeders and breakers
- h. Provide space in the electrical room layouts for the future addition of equipment. For each switchboard lineup in a new facility and for switchboards rated 800 amps and higher, include floor space for one additional switchboard section. All switchboards shall have full-sized horizontal bussing to allow for additional sections to be added.
- i. Where panelboards are mounted recessed flush in a wall, maintain fire integrity of the wall. Provide one empty 3/4" electrical metallic tubing (EMT) conduit stubbed up into nearest accessible ceiling location for every three spare single-pole or space-equivalent positions.

**DIVISION TWO
TECHNICAL CRITERIA**

- 11 Architectural Criteria
- 12 Structural Criteria
- 13 Mechanical Criteria
- 14 Building Management System Criteria

15 ELECTRICAL CRITERIA

- 15.A Objectives
- 15.B Electrical Criteria
- 15.C Emergency and Standby Power Systems
- 16 Lighting Criteria
- 17 Network and Communication Systems
- 18 Audiovisual Systems
- 19 Acoustical Criteria
- 20 Fire Protection Criteria

- j. The distribution transformers feeding receptacle power for office areas shall be K-rated to compensate for harmonics generated by office equipment. The distribution transformers feeding MDF and IDF rooms shall have K-ratings appropriate for the proposed equipment loads. The neutral conductors on the secondary of K-rated transformers shall be sized at 150 percent rated ampacity of the phase conductor.
- k. To facilitate future installation of rooftop communication systems, an electrical subpanel and submeter shall be provided on the rooftop. Conduit pathways shall be provided to the rooftop from the electrical room with pull rope (not pull string) to allow for cable runs to be added for future installations.
- l. Full-sized neutral conductors shall be used throughout the project for three-phase (3PH), four-wire (4W) service, power, and lighting feeders.
- m. True root-mean-square meters shall be used wherever meters are specified on switchgear and distribution boards.
- n. Separate electrical panels and metering may be required for noncourt occupancies in the facility, including but not limited to rooftop communication systems. Review with the Judicial Council to establish specific project requirements. Provide meters for each load group and floor, including, at a minimum:
 - Total electrical consumption (Main);
 - Exterior lighting;
 - Interior lighting on a per-floor basis;
 - Receptacle loads on a per-floor basis;
 - Vertical transportation;
 - Heating, ventilation, and air-conditioning (HVAC) equipment;
 - Plumbing equipment;
 - Information technology (IT) rooms;
 - Electric vehicle (EV) charging stations; and
 - Onsite power generation (photovoltaic panels) and battery energy storage system (BESS), if applicable.
- o. In office areas, the ceiling space shall typically be used for the distribution of power, data, and communication systems. The distribution drops shall be contained in columns and walls to offices and workstation spines. Power, voice, and data poles may be used on a case-by-case basis if approved by the Judicial Council.
- p. Fire-rated poke-through floor outlets may be used only where ceilings below are accessible and the occupancies below are not compromised by the installation of conduit in the ceiling space. Where poke-through outlets are used, minimize conduits and cables in the ceiling space below by using the nearest partition to return the conduits and cables to the ceiling of the floor supplied. In-slab floor boxes may be used for limited areas where interior layouts are not subject to change, such as main lobbies, courtrooms, weapons-screening areas, large training rooms, or other similar locations.
- q. The electrical equipment and systems shall be specified to include startup, testing, training, and adjusting per the applicable codes, recognized industry standards, and equipment system manufacturer requirements.
- r. Switchboards, distribution panels, transformers, disconnects, and branch circuit

panelboards throughout the building shall be of commercial grade and manufactured by one manufacturer.

- s. All panelboards shall include door-in-door trim and copper bus. All equipment enclosures shall be a National Electrical Manufacturers Association (NEMA) type suitable for the environment they are located in.
- t. All electric motors above 1/2 horsepower shall be three-phase, where available. This requirement shall be coordinated across the project with other disciplines.
- u. Regarding wiring devices, all power receptacles and switches for general-purpose circuits shall be NEMA specification grade, manufactured by one manufacturer, and rated for specific environment and application. Outlets served from an emergency or standby power system shall be red.
- v. All floor- or pad-mounted equipment such as motor control centers and transformers shall be provided with aluminum bus. Indoor equipment shall be installed on a minimum 4" high concrete housekeeping pad; outdoor locations shall be installed on a minimum 6" housekeeping pad. Confirm pad requirements with serving utility company.
- w. The design shall include equal distribution of load on each phase for the feeders, balanced within 15 percent between phases, documented with submission of 100 percent of the construction documents.
- x. The criteria for the systems named in the following chapters of the *Facilities Standards* are specified in those chapters.
 - Chapter 4, Courthouse Security
 - Chapter 13, Mechanical Criteria
 - Chapter 16, Lighting Criteria
 - Chapter 17, Network and Communication Systems
 - Chapter 18, Audiovisual Systems
 - Chapter 20, Fire Protection Criteria

2. Harmonics

The engineer shall provide a study to determine the level of harmonics and account for the harmonics in the design of transformers, feeders, and branch circuits. Consideration shall be given to computer and/or digital equipment, variable-frequency drives, and elevators.

3. Conductors

The following types of conductors shall be specified based on each one's application.

- a. All wire, cable, and equipment shall be new.
- b. All wire #8 AWG (American Wire Gauge) and larger shall be stranded copper or aluminum.
- c. All wire #10 AWG and smaller shall be solid copper.
- d. All wire and cable for secondary power distribution shall be 600-volt insulated THHN (thermoplastic high-heat-resistant nylon-coated) or THWN (thermoplastic heat- and water-resistant nylon-coated) for #8 and smaller. THWN, THHN, and XHHW (cross-linked polyethylene, high-heat resistance, water resistance) should be used for #6 and larger and for wet, underground, and exterior locations. RHH (rubber-insulated, high-

DIVISION TWO TECHNICAL CRITERIA

- 11 Architectural Criteria
- 12 Structural Criteria
- 13 Mechanical Criteria
- 14 Building Management System Criteria
- 15 ELECTRICAL CRITERIA**
- 15.A Objectives
- 15.B Electrical Criteria
- 15.C Emergency and Standby Power Systems
- 16 Lighting Criteria
- 17 Network and Communication Systems
- 18 Audiovisual Systems
- 19 Acoustical Criteria
- 20 Fire Protection Criteria

heat resistant) or THHN 90 degrees Celsius standard should be used for fixture wire and circuit runs within fixtures.

- e. Multiwire branch circuits shall be provided with a means to simultaneously disconnect all ungrounded conductors at the point where the branch circuit originates, i.e., handle ties or multipole circuit breakers.
- f. All wire shall be color-coded throughout. The system conductors shall be identified as to phase connections by means of color-impregnated insulation.
- g. Power and lighting branch circuits shall be specified not less than #12 AWG.
- h. Signal and control circuits shall be specified not less than #14 AWG.
- i. The cabling for fire alarm, security, telecommunications, and audiovisual (AV) systems shall be specified in accordance with the respective section requirements.
- j. Specify that the cable ducts for power are not shared with data and communication systems.
- k. All bus ducts shall be aluminum.

4. Conduits

The following shall be specified as a minimum requirement for conduits.

- a. Minimum acceptable EMT conduit size shall be 3/4" diameter, except for short runs to a single outlet and for single fixtures, which may be 1/2".
- b. For indoor locations subject to physical damage, use rigid steel or intermediate metal conduit with zinc coating inside and out with hot-dipped galvanizing and conforming to American National Standards Institute's ANSI C80.1 and Underwriters Laboratories (UL). Couplings and unions shall be electroplated steel, threaded type.
- c. For interior spaces in dry locations, use cold-rolled steel EMT tubing with enamel coating inside and zinc coating outside and galvanized steel fittings. Steel-armored metal-clad (MC) cable shall be permitted for distribution of branch circuits where routed in concealed locations and installed with hangers and supports specifically approved for MC cable systems. MC cable shall be independently supported and shall not rely on ceiling or wall framing for support. MC cable shall not be used in exposed locations. MC cable is not permitted for circuit home runs.
- d. Underground electrical service and underground distribution shall be polyvinyl chloride (PVC)-coated galvanized rigid steel, concrete encased, or schedule 40 PVC, concrete encased. Elbows shall be PVC-coated rigid steel. All underground feeders shall be installed with spacers for proper support. Where installed under building slabs, concrete slurry shall be permitted in lieu of concrete duct banks.
- e. In wet and outdoor locations, specify cadmium-plated cast malleable iron liquid-tight fittings with insulated throat.
- f. Flexible metallic conduits of limited lengths may be used at power terminations to equipment in indoor and dry locations. For outdoor and wet locations, they shall be liquid-tight with plastic jacket extruded over the outer zinc coating.
- g. Conduits in slabs on metal decks are not permitted.

5. Quality Assurance

- a. All materials, devices, and equipment shall be commercial grade, new, and UL listed.

- b. The electrical system design shall be in conformance with the applicable codes and standards and the requirements of these criteria.
- c. Certain material, equipment, apparatus, or other products may be specified by manufacturer's brand name, type, or catalog number. In such cases, the designated product shall meet the established standards for quality, style, utility, and performance.
- d. The main switchboard, distribution panels, transformers, disconnects, and branch circuit panelboards shall be manufactured to commercial-grade specifications by a manufacturer with a minimum of 10 years' experience in the manufacture of such equipment.

6. Electric Distribution Studies

In addition to the electrical load and short circuit studies required by the codes, each project shall include electrical coordination and arc flash risk analysis studies to confirm compliance with codes and building operational requirements. The engineer of record shall review and approve the study before the contractor may place the order for manufacturing of the equipment.

7. Identification

The electrical system shall be specified to include identification and signage in accordance with ANSI standards and NFPA 70 and 70E requirements. Specify identification at all power service switchboards, power distribution panels, transformers, conduits, branch circuits, pull boxes, outlet covers, and junction boxes using industry-standard materials and methods.

Electrical light fixtures and convenience outlets on emergency power circuits shall be identified with a system of unique identification. The identification tags shall be applied on location and be easily identifiable and uniformly applied throughout the building. Receptacles shall be labeled with panel and circuit number.

Conduits and boxes shall be color coded for specialty systems. Emergency power conduits shall have a circumferential red mark every 10', and boxes shall be marked with a diagonal red stripe on the cover. Fire alarm systems shall be color coded red; building management system (BMS) shall be blue. Other systems shall have similarly designated colors.

8. Coordination

The electrical work shall be coordinated with the work of all other divisions to interface power and control requirements to equipment, devices, lighting, control systems, and other systems specified under the respective divisions.

9. Power Distribution System

- a. For new facilities, a three-phase, four-wire power service shall be delivered to the building via utility transformers that are located in a vault or pad mounted. The voltage shall be 277/480 volts (V) or 120/208V, depending on square footage and equipment needs. The location of the transformer shall be properly coordinated with the local utility company. The designer shall coordinate with the utility company on proper sizing of the service based on load calculations and including 15 percent spare capacity for future growth.
- b. Branch circuit panelboards will be located throughout the facility. The panels will be fed from breakers in the main switchboard or from distribution panelboards. Dry-type step-down transformers will be provided where required, which will in turn feed 120/208V 3 PH 4W distribution-type panelboards or distribution panels. Provide K-rated transformers as required. The 120/208V branch panelboards located throughout

**DIVISION TWO
TECHNICAL CRITERIA**

- 11 Architectural Criteria
- 12 Structural Criteria
- 13 Mechanical Criteria
- 14 Building Management System Criteria

15 ELECTRICAL CRITERIA

- 15.A Objectives
- 15.B Electrical Criteria
- 15.C Emergency and Standby Power Systems

- 16 Lighting Criteria
- 17 Network and Communication Systems
- 18 Audiovisual Systems
- 19 Acoustical Criteria
- 20 Fire Protection Criteria

the facility will be fed from breakers in these distribution panels. Large air-conditioning and motor loads will be supplied at 480V or 208V 3 PH from the new main switchboards and distribution boards.

- c. Lighting fixtures will be connected to 20 amp, single-pole circuit breakers in lighting branch circuit panelboards.
- d. Convenience and special power receptacles will be provided as required throughout the facility. Convenience receptacles and miscellaneous loads will be connected to 120/208V 3 PH 4W branch circuit panelboards.
- e. Provide controlled receptacles as required by the California Energy Code (Cal. Code Regs., tit. 24, pt. 6).
- f. Where a centralized UPS is not provided, computer and other sensitive electronic loads will be fed through point-of-use, localized UPS units as required to meet the standards.
- g. For equipment supplied by K-rated transformers, neutral bussing and conductors for distribution equipment feeding panelboards will be sized to accommodate harmonic currents generated by electronic power supplies.
- h. Surge protective devices (SPD's) shall be provided for overvoltage protection per California Electrical Code (CEC) article 242.

10. Grounding System

- a. A complete grounding system shall be provided per the California Electrical Code. The electrical system shall be grounded to a common building grounding electrode system, which uses grounding to building steel, building cold-water pipes, and concrete-encased electrodes. Grounding to cold-water pipes shall be only to continuous metallic main pipe. Where the cold-water pipe has insulated joints or plastic pipe connectors, properly sized jumper cables shall be specified to maintain the continuity of the pipe grounding.
- b. The grounding system for utility service transformers shall be provided per the local utility company criteria. The building emergency generator shall be grounded per code.
- c. Provide a copper main ground bus in the main switchboard room and connect to the building grounding electrode system. Provide a grounding riser in the building with a ground bus located at each electrical room. Transformers and other separately derived systems shall be bonded to this ground bus system in addition to bonding to other code-required connections.
- d. Telecommunications equipment rooms shall be grounded per the requirements of chapter 17, Network and Communication Systems. The telecommunications grounding system shall be connected to the main ground bus.
- e. For existing buildings, the grounding shall tie back to the nearest building grounding electrode system, including the building steel and building cold-water pipes.
- f. Specify grounding grid for raised-floor computer rooms. Within the room, bond all metallic pipes, conduits, and steel equipment housings to the grounding grid.
- g. Each project shall be evaluated for the requirements of a lightning protection system. The risk assessment shall follow NFPA 780, Annex L.

11. Photovoltaic and Battery Storage

If energy generation, such as photovoltaic panels, and battery storage are part of the scope of the project, minimum California Code of Regulations code requirements shall be met.

15.C EMERGENCY AND STANDBY POWER SYSTEMS

1. General Requirements

- a. The need for and capacity of the emergency and standby power system shall be carefully evaluated, based on the code requirements, project size, and location. The purpose of an emergency and standby power system is to provide safe evacuation of the court building and to allow for the orderly shutdown of building systems as required by the California Building Code (CBC). Emergency and standby power will not be provided for any other purpose without prior approval of the Judicial Council. In remote project areas with limited accessibility, or if the court building will also serve as an emergency operations center, the generator size and fuel storage capacity may be designed to meet local requirements, but only with prior approval of the Judicial Council.
- b. Unless approved otherwise, emergency generators shall include only the systems outlined in California Code of Regulations, title 24, and this section 15.C. For loads that are not required to be connected to the generator either by CBC or *Facilities Standards*, a study shall be completed for the project, supporting the need for additional loads. The study shall require formal approval by the Judicial Council before its findings are incorporated into the design. Before procurement of materials early in the construction phase, a construction submittal shall be sent for formal approval to both the Judicial Council and the Office of the State Fire Marshal verifying the loads connected to the generator.
- c. Each project shall undergo an evaluation to document the specific need for emergency and standby power. The evaluation shall include the following:
 - A site utility reliability review documenting the power sources available, redundancy inherent in the utility supply, and outage history.
 - Code analysis.
 - Fuel storage capacity to meet code requirements and site accessibility for refueling.
 - Statement of the impacts of utility power loss.
 - Identification of the specific systems and loads for support, and categorization by requirements (code, function, etc.). Include backup time required for fuel/battery design.
 - Review of appropriate generator or battery systems that best meet code and local air quality district requirements.
 - Confirmation of generator exhaust and after-treatment requirements by the local air quality district.
- d. Electrical generators to supply emergency power and standby power are to be provided only where the electrical loads can be demonstrated to be best accommodated by a generator set or battery and as required by code. Factors to be considered include locations with a history of significant outage occurrences or sustained periods of power interruptions. The duration of emergency power supply shall be determined by the building and fire codes. Additional consideration may be made based on the time necessary to prudently shut down critical systems and to safely evacuate and close the building, whichever time is greater.

DIVISION TWO TECHNICAL CRITERIA

- 11 Architectural Criteria
- 12 Structural Criteria
- 13 Mechanical Criteria
- 14 Building Management System Criteria
- 15 ELECTRICAL CRITERIA**
- 15.A Objectives
- 15.B Electrical Criteria
- 15.C Emergency and Standby Power Systems
- 16 Lighting Criteria
- 17 Network and Communication Systems
- 18 Audiovisual Systems
- 19 Acoustical Criteria
- 20 Fire Protection Criteria

2. Emergency Generators

2.1 Requirements Based on California Electrical Code

- a. The following requirements shall be considered as minimum criteria. In all cases, the requirements of the code and the authority having jurisdiction, including but not limited to the Office of the State Fire Marshal, shall govern the system provisions.
- b. On projects where it is determined that an emergency generator is required to serve the courthouse buildings, the loads identified in items 1 and 2 below and any other code requirements will be designed to be supported by that generator. Per the CEC, the emergency/standby system includes three branches: code-required emergency loads, legally required standby, and optional standby (noncode emergency loads). Provide a minimum of three automatic transfer switches, one for each branch. The breaker serving the automatic transfer switches on the emergency and/or standby side shall be in separate vertical sections, per the CEC. The distribution for these branches shall be separate, as well. Loads shall be segregated as follows:

Emergency Systems: Systems that are legally required for automatic illumination or power for safe exiting and panic control in buildings essential for safety to human life (as defined by CEC article 700, CBC chapter 27, California Fire Code (CFC) chapter 12, NFPA 110, and NFPA 111), such as:

- Fire pumps, including jockey pumps;
- Egress path lighting and exit signs; and
- Doors and locks for cells.

Legally Required Standby Systems: Systems that are required to avoid interruptions to fire-fighting operations (as defined by CEC article 701, CFC chapter 12, NFPA 110, and NFPA 111) or other systems that ensure safety or facilitate rescue, such as:

- Elevator systems (only if elevators are required to be on the generator), including:
 - Elevators;
 - Elevator machine room ventilation;
 - Elevator cab lighting;
 - Elevator hoistway lighting;
 - Elevator recall power; and
 - Elevator control/status panels;
- Fire alarm and life-safety systems (including emergency voice alarms);
- Fire and life safety in MDFs or IDFJs that are on the converged network (network switches);
- Horizontal sliding doors, if part of egress path; and
- The smoke control system (if it is required on the project), including:
 - All fans and motors associated with the system;
 - Fire smoke dampers;

- Smoke curtains; and
- Pressurization fans for paths of egress.

Optional Standby Systems: Systems intended to supply power where life safety does not depend on the performance of the system (as defined by CEC article 702), provided only with prior approval by the Judicial Council.

Emergency Responder Radio Communication System (ERRCS): ERRCS shall not be connected to the generator but be on its own UPS system that provides no less than 12 hours of power.

2.2 General Requirements for Emergency Generators

Early in the project, the design team shall define what building systems have emergency and standby power and monitor any changes that would increase the size of the emergency and standby power system. Other important considerations and directives follow.

- Check generator fuel storage amounts and occupancy classifications against California Fire Code, California Building Code, NFPA 30, NFPA 37, and NFPA 110.
- Identify the minimum and maximum size of the fuel tank. Include the setback requirements per NFPA 30.
- No foreign systems should be installed in generator room per NFPA 110.
- Combustion air and cooling intake should not be installed through rated partitions.
- Address temperature exhaust running through load bank. Address general cooling—and heating, if required—of the generator room.
- Confirm that flue is installed in rated shaft. Confirm three-hour rated enclosure, including deck, per NFPA 37.
- Confirm access for installation and maintenance. Confirm that the Emergency Power Off switch is located outside generator room.
- Recommend placing generator in an acoustically designed exterior enclosure.
- Provide connection from the generator to the fire alarm system for monitoring.
- Provide connection from the generator to the BMS for monitoring, per 15.C.4, Building Management System Interface.

2.3 Detailed Requirements for Emergency Generators

For projects where an emergency generator is provided, the following requirements shall be met.

- The automatic emergency power system shall consist of a 120/208V or 277/480V 3 PH 4W generator set, water-cooled radiator type. The engine generator set shall be located indoors, or at grade. Exterior generator sets shall be provided with a lock-secured, alarmed, weatherproof, sound-attenuating enclosure to meet the acoustical requirements of the site.
- Fuel vent calculations shall be provided per NFPA 30 and exhaust vent calculations per the California Mechanical Code (CMC).
- Exterior enclosures shall be secure under lock and have emergency power

DIVISION TWO TECHNICAL CRITERIA

- Architectural Criteria
- Structural Criteria
- Mechanical Criteria
- Building Management System Criteria

15 ELECTRICAL CRITERIA

- Objectives
 - Electrical Criteria
 - Emergency and Standby Power Systems
- Lighting Criteria
 - Network and Communication Systems
 - Audiovisual Systems
 - Acoustical Criteria
 - Fire Protection Criteria

- service and emergency lighting. Provide excess buffer space around main electrical gear from building components to allow a flexible installation, and provide adequate space for future replacements and maintenance. Provide phone data lines for remote metering and a status panel for remote locations.
- d. Automatic transfer switches shall be provided. Provide open transition between normal and emergency positions, or as directed by the local utility provider.
 - e. Fuel sources shall be evaluated based on all pertinent criteria. If a diesel engine is selected, it shall be provided with an integral base-mounted day tank. The following other possible fuel sources shall be considered:
 - Dual fuel with a natural gas connection and a local liquid propane gas tank.
 - Bi-fuel generator using diesel for starting and then running on natural gas.
 - Electrical battery energy storage system
 - f. Other sources of emergency and standby power as defined by CEC article 700.12 shall be considered. These include, but are not limited to:
 - UPS; and
 - Direct-current microgrid systems.
 - g. Engine-mounted critical-type exhaust muffler and double contained integral-type fuel oil day tank with fuel-leak detection system shall be specified.
 - h. Diesel generator exhaust shall be carefully located to prevent entry of fumes into building HVAC system and building openings, per CMC.
 - i. A load bank shall be provided for the generator, sized for 30 percent of generator capacity. The load bank may be shared with a centralized UPS, provided that the load bank is stationary (not generator mounted).
 - j. Fuel oil storage tank shall be above grade, with proper filling and monitoring systems. The day tank shall be of the manufacturer's standard size, based on the generator capacity. Installation of a fuel-leak detection system is required.
 - k. Emergency generator shall be located a minimum of 50' away from primary electrical source.
 - l. The following areas in the building shall have emergency and/or standby lighting on the emergency and/or standby power source, as a minimum (refer to the CBC, CEC, and CFC):
 - Detention areas, custody areas, and sally port
 - Exit signage
 - Exit corridors and stairwells
 - Assembly rooms, such as courtrooms
 - IT/AV equipment rooms (MDF, IDF, etc.)
 - Generator, electrical, mechanical, and elevator equipment rooms, and exterior generator enclosures
 - Security and detention control equipment locations (security operations center, detention control room)

- m. Emergency and/or standby power shall be provided for holding areas in accordance with the California Building Code.

2.4 Spare Capacity

All electrical panels fed from emergency and/or standby sources shall be adequately sized to power the building emergency and standby loads, in addition to providing the spare capacity listed in table 15.1.

2.5 Temporary Emergency Generator

Per the California Electrical Code, when a building is provided with a permanently installed emergency generator, a connection for a temporary generator with capacity to support emergency loads is required. This requirement allows permanent emergency generators to be taken offline for maintenance without disruption to the power supply.

3. Uninterruptible Power Supply

Systems where an outage of 10 seconds (to transfer from normal to emergency power) could damage essential equipment or impair safety shall be on UPS power. The areas served by the UPS shall include, but are not limited to:

- Security operations center, main and secondary equipment locations, including cameras and communication systems;
- Computer servers (MDF, IDF, BMS); and
- Telephone switches.

UPS shall not be connected to generator power. Following are the detailed requirements for UPS, when provided.

- a. Any UPSs shall be provided per NFPA 111.
- b. UPSs shall be small, localized, rack-mounted units to serve individual racks or equipment. In a larger facility, one or more centralized UPSs may be appropriate. During the project’s schematic design phase, a review shall be provided of the projected UPS loads along with their locations and supporting functions to determine the optimal UPS system solution for the facility. In the study, the required battery backup time shall be confirmed, taking into consideration outage scenarios and the availability of onsite generators.
- c. The design team shall define early in the project what is included in the UPS and control the scope creep; identify amperage, voltage, and run time of the UPS; and confirm who is responsible for design and construction of the UPS in the contract.
- d. UPS for the data processing equipment shall include rectifier/battery charger, solid-state inverter, static bypass transfer switch, maintenance-free batteries sized for 90 minutes, and synchronized circuitry. External maintenance bypass switches shall be provided.
- e. The full complement of technology-related systems housed inside communications spaces (MDF/IDF rooms) shall have adequate UPS power backup to support electrical interruptions for 90 minutes for non-life-safety equipment.
- f. Coordination shall be included for the UPS and generator systems (if applicable) to address capacity, compatibility, and code requirements.
- g. Centralized UPS systems shall include a load bank for testing, and the load banks may be shared with the generator systems, provided the load bank is not generator mounted.

**DIVISION TWO
TECHNICAL CRITERIA**

- 11 Architectural Criteria
- 12 Structural Criteria
- 13 Mechanical Criteria
- 14 Building Management System Criteria

15 ELECTRICAL CRITERIA

- 15.A Objectives
- 15.B Electrical Criteria
- 15.C Emergency and Standby Power Systems
- 16 Lighting Criteria
- 17 Network and Communication Systems
- 18 Audiovisual Systems
- 19 Acoustical Criteria
- 20 Fire Protection Criteria

4. Building Management System Interface

- a. Coordinate with the BMS to control, monitor, alarm, and data log the following electrical power information, at a minimum:
 - Building normal and emergency power consumption and demand.
 - Load types by system.
- b. Coordinate with the BMS to provide system monitoring for the following electrical systems:
 - Emergency generator alarms, including but not limited to engine-trouble, low-fuel, fuel-leak, low-voltage, and loss-of-phase alarms.
 - UPS alarms, including but not limited to load-on-battery, load-on-bypass, high-temperature, and UPS emergency-power-off alarms. Provide a full list of possible alarms to the Judicial Council during design. The Judicial Council shall determine what it would like annunciated as an alarm.
 - Fire alarms, including supervisory and trouble signals.
- c. Coordinate with the BMS to provide an interface for lighting controls, including interior and exterior lighting.

DRAFT

16

DIVISION TWO: TECHNICAL CRITERIA

LIGHTING CRITERIA

SECTION	TOPIC	PAGE
16.A	Objectives	16.2
16.B	Lighting Criteria	16.2
16.C	Lighting Strategies	16.6
16.D	Lighting Controls	16.9
16.E	Lighting Commissioning	16.11



Governor George Deukmejian Courthouse, County of Los Angeles
Long Beach, CA
AECOM

Designers are encouraged to minimize types of luminaires and replacement lamps.

This chapter defines the general and technical criteria for lighting systems and encompasses recommendations for best practices, energy efficiency, sustainability, and creation of productive work environments that emphasize the dignity and importance of activities conducted in the facility.

16.A OBJECTIVES

Lighting design in the court facility shall be functional, appropriate for users, energy-efficient, and easy to maintain and shall maximize use of modern and appropriate technology. Daylight in occupied spaces is desirable but must be carefully controlled to avoid glare and minimize heat gain. In security-sensitive spaces, minimize views into the space from outside the building. Direct sunlight penetration into functional court spaces shall be avoided to prevent high light and shadow contrast and glare.

16.B LIGHTING CRITERIA

1. General

- a. Refer to tables 16.1 and 16.2 for recommended illuminance levels.
- b. Lighting designs shall meet the power density requirements of the current California Energy Code (Cal. Code Regs., tit. 24, pt. 6).
- c. Lighting-level calculations (for normal and emergency settings) shall be provided by the designer at the end of the design development phase. Calculations shall include all interior spaces and all exterior areas within the project boundaries.

2. Reflectance Values

Indirect or direct and indirect lighting systems shall be the preferred system. The reflectance of surrounding surfaces greatly affects the quality of the lighting system and energy-efficiency levels. Surrounding surface reflectance values shall comply with criteria noted in table 16.3.

3. Light Engine Performance Requirements

Refer to table 16.4 for lighting systems light-emitting diode (LED) performance requirements.

4. Light Engine Selection

- a. Lighting systems shall be primarily solid-state lighting, such as LED lamps, to maximize energy efficiency and minimize maintenance.
- b. Preference should be given to LED luminaires with replaceable drivers, to aid long-term maintenance and serviceability.
- c. Maintenance of such systems shall be discussed during the design process to ensure longevity of the installed system.
- d. Renovated facilities shall develop a plan to phase out and upgrade current mercury-containing fluorescent lamps to LED technology.
- e. Fluorescent, incandescent, halogen, induction, and high- and low-pressure sodium sources shall not be used unless required by local or city ordinances. Mercury vapor sources shall not be used.
- f. Design lighting and controls to accommodate videoconferencing where programmed in courtrooms, conference rooms, chambers, or mediation areas.
- g. Illuminated exit signs shall utilize LED lamp technology and shall use less than 5 watts of power.

Table 16.1 Recommended Interior Illuminance Levels

SPACE DESCRIPTION*	RECOMMENDED AVERAGE HORIZONTAL ILLUMINATION LEVEL (FC)†	RECOMMENDED AVERAGE VERTICAL ILLUMINATION LEVEL (FC)‡	OTHER CONSIDERATIONS
Courtrooms			
Judge’s Bench	45–55	19	Additional task lighting may be desirable from ceiling.
Clerk’s Desk	45–55	19	Additional task lighting may be desirable from ceiling.
Spectator Seating	15–25	5	
Litigant’s Table	45–55	19	Additional task lighting may be desirable from ceiling.
Podium	45–55	19	Additional adjustable task lighting is recommended.
Witness Chair	30–40	14	
Offices			
Intensive VDT Use Offices	30–40	—	Additional task lighting may be desirable.
Intermittent VDT Use Offices	45–55	—	Additional task lighting may be desirable.
Other Areas			
Conference Rooms	30–40	7–28	
Jury Assembly Areas	10–30	5–19	Provide multiple levels of light for various room functions.
Waiting Areas / Lounges/Cafés	10	—	
High-Density Files	—	7–19	Provide vertical illumination to within 30” of the floor.
Public and Private Circulation	15–20	—	
Staff Circulation	5–10	—	
Public Lobbies	15–20	—	
Holding Areas	25–35	5–9	
Restrooms	10–20	3–19	
Mechanical/Plumbing Rooms	10	—	
Electrical/AV/Telecom Rooms/ MDF/Mailroom	50	—	

* For areas not listed, refer to the online Illuminating Engineering Society (IES) Lighting Library (ies.org) for illumination guidelines. If the light level recommendations stated in the IES Lighting Library differ from these standards, project designers shall notify the Judicial Council for review and approval of proposed target light levels.

† FC = foot-candles. Value ranges are for average general illumination at work-plane height, unless noted otherwise. Task illumination requirements are higher.

‡ Value ranges are for average illumination at facial height, unless otherwise noted.

AV = audiovisual; MDF = main distribution frame; VDT = visual display terminal.

**DIVISION TWO:
TECHNICAL CRITERIA**

- 11 Architectural Criteria
- 12 Structural Criteria
- 13 Mechanical Criteria
- 14 Building Management System Criteria
- 15 Electrical Criteria
- 16 LIGHTING CRITERIA**
- 16.A Objectives
- 16.B Lighting Criteria
- 16.C Lighting Strategies
- 16.D Lighting Controls
- 16.E Lighting Commissioning
- 17 Network and Communication Systems
- 18 Audiovisual Systems
- 19 Acoustical Criteria
- 20 Fire Protection Criteria

Table 16.2 Recommended Exterior Illuminance Levels

SPACE DESCRIPTION*	RECOMMENDED MINIMUM HORIZONTAL ILLUMINATION LEVEL (FC)†	RECOMMENDED MINIMUM VERTICAL ILLUMINATION LEVEL (FC)‡	OTHER CONSIDERATIONS
Parking Areas			
Parking Garage—General	1.0	0.5	
Parking Garage—Ramps	1.0	0.5	Daytime minimum horizontal is 2.0 FC. Daytime minimum vertical is 1.0 FC.
Parking Garage—Entrance	1.0	0.5	Daytime minimum horizontal is 50 FC. Daytime minimum vertical is 25 FC. Daytime light level may include daylight.
Parking Garage—Stairways	2.0	1.0	
Open Parking Lots	0.5 (asphalt) 1.0 (concrete)	0.25	Provide 15:1 maximum-to-minimum uniformity ratio.
Other Exterior Areas			
Active Building Entries	5.0 Average	3.0	
Inactive Building Entries	3.0 Average	3.0	
Pedestrian Pathways	1.0	0.3–0.65	
Stairways	1.0	0.3–0.60	

* For areas not listed, refer to the online Illuminating Engineering Society (IES) Lighting Library (ies.org) for illumination guidelines. If the light level recommendations stated in the IES Lighting Library differ from these standards, project designers shall notify the Judicial Council for review and approval of proposed target light levels.

† Value ranges are for average general illumination at work-plane height, unless noted otherwise. All exterior target light levels are to be determined per project based on security equipment, local ordinances (if any), and emergency egress requirements.

‡ Value ranges are for average illumination at facial height, unless otherwise noted.

Table 16.3 Recommended Reflectance Levels

ROOM SURFACE	RECOMMENDED REFLECTANCE
Ceilings	Minimum reflectance shall not be below 85%.
Walls, Systems Furniture Partitions	Generally, walls should not be below 60% reflective, but occasional accent walls that are between 40% and 60% reflective will be acceptable. The interior finish schedule shall have a column indicating light reflectance of any materials used in courtrooms or offices.
Floors	Reflectance shall be approximately 20%.

**DIVISION TWO:
TECHNICAL CRITERIA**

- 11 Architectural Criteria
- 12 Structural Criteria
- 13 Mechanical Criteria
- 14 Building Management System Criteria
- 15 Electrical Criteria

16 LIGHTING CRITERIA

- 16.A Objectives
- 16.B Lighting Criteria
- 16.C Lighting Strategies
- 16.D Lighting Controls
- 16.E Lighting Commissioning

- 17 Network and Communication Systems
- 18 Audiovisual Systems
- 19 Acoustical Criteria
- 20 Fire Protection Criteria

Table 16.4 Lighting Systems LED Performance Requirements

	INTERIOR	EXTERIOR
Fidelity Index (R_f)	>78	>70
Gamut Index (R_g)	$92 > R_g > 110$	$80 > R_g > 120$
Minimum Fidelity Red (R9) Value	30	20
Minimum Efficacy	75 lumens per watt	100 lumens per watt
Minimum L70 Lifetime (extrapolated)	80,000 hours	100,000 hours
MacAdam Ellipse	Maximum three-step MacAdam ellipse variation throughout listed life (L70)	Maximum four-step MacAdam ellipse variation throughout listed life (L70)
Legacy Color Rendering Index (CRI); Minimum Average CRI Value (R_a)	80	70

Each project design team shall develop a luminaire specification that uses the least number of types required to satisfy the design in an effort to simplify maintenance.

As design teams endeavor to reduce exterior lighting energy consumption during inactive periods at night, the exterior lighting design should strive to maintain the uniformity of light during the reduced-light-level scenario, which can help contribute to the sense of safety in pedestrian areas and parking lots at night.

5. Luminaire Selection

Custom-designed luminaires are not permitted. Avoid trendy luminaires or materials; instead, use durable, readily available, off-the-shelf luminaires. Luminaires shall be selected on the basis of maintaining a 25-year life cycle with the facility. Luminaires shall be evaluated on the basis of effectiveness and long-term life cycle costs, especially for characteristics and components that ensure longevity and quality, not just lowest first costs.

6. Visual Criteria

Luminaires shall be selected and located to minimize direct or reflected glare. When multiple luminaires are specified, the specifier shall ensure that the luminaires meet equivalent performance standards.

7. Energy-Efficiency Criteria

The most efficient luminaires that provide visual comfort necessary for the activity shall be used.

8. Maintenance Criteria

Lighting maintenance (including but not limited to component replacement) is a significant portion of the ongoing court building operating cost; the limited resources available for operation and maintenance must be conserved. Therefore, lighting designs shall, at a minimum, provide:

- Readily apparent access to all luminaire assemblies for driver and array replacement (do not use or locate luminaires such that they require special lifts or overly specialized equipment to access them);
- Removable shielding devices with cables or chains to hold the device to the luminaire during relamping; and
- LED luminaires that have a replaceable driver, when that option is available.

16.C LIGHTING STRATEGIES

The following requirements address various spaces in and around the facility.

1. Exterior Lighting

The primary purpose of exterior lighting is to provide safety and security for those entering and exiting the building outside of daylight hours.

- a. Exterior lighting shall be compatible with security cameras used on the site. Typically, an average to minimum uniformity ratio of 4:1 shall be achieved, with well-shielded luminaires out of view of cameras. Lighting levels do not need to be high if the light source is of good color quality, uniformity is high, and glare is minimized.
- b. Lighting levels shall be determined for each project based on camera technology and local site requirements. (See table 16.2, Recommended Exterior Illuminance Levels.)
- c. Exterior lighting shall not contribute to light pollution or trespass by emitting light beyond the property. Minimize glare and unwanted light for neighbors. The U.S. Green Building Council's Leadership in Energy and Environmental Design (LEED) for Building Design and Construction (Sustainable Sites credit category: Light Pollution Reduction) shall be used as a guideline for developing the exterior lighting plan, as shall the code-required light pollution reduction measures in the California Green Building Standards Code (CALGreen; Cal. Code Regs., tit. 24, pt. 11). Designers should consider

specifying LED luminaires compliant with the International Dark-Sky Association requirements—specifically, a correlated color temperature of 3,000 kelvin or less.

- d. Outdoor lighting shall have photo sensors or an astronomical time clock for control. Exterior luminaires should be specified to minimize the opportunity for vandalism. For example, in-grade landscape lighting with vandal-resistant hardware is preferred over above-grade adjustable landscape accent lights.
- e. Light bollards are discouraged because of potential damage and maintenance issues.
- f. Luminaires shall be provided for all flagpoles.
- g. Designers shall use LED sources with integrated occupancy/motion controls in parking lot luminaires. Emergency lighting shall be exempt from this requirement.
- h. Exterior lighting levels shall be reduced rather than turned off during nighttime hours of inactive periods in compliance with CALGreen. Lighting required for emergency lighting or nighttime security shall be exempt.

2. Security Lighting

- a. Determine security lighting requirements at entries, screening stations, or wherever programmed, and coordinate with the security equipment specifications. Faces appearing in cameras must be lit. Color rendition for security needs shall be improved by specifying LED luminaires that have been successfully evaluated to have a minimum fidelity index and skin fidelity index of at least 78, as tested by the methodology defined in American National Standards Institute and Illuminating Engineering Society’s ANSI/IES TM-30-18, *IES Method for Evaluating Light Source Color Rendition*.
- b. In larger facilities with a centralized lighting control system, provide means within the security operations center to manually override the reduced level of exterior lighting for security purposes.
- c. Provide a comprehensive nighttime security lighting scheme—to be discussed with the Judicial Council’s Emergency Planning and Security Coordination unit and coordinated with the architectural design team—to satisfy both security needs and the architectural design intent establishing the nighttime civic presence of the facility.

3. Emergency Lighting

- a. To maximize energy savings, designers may consider providing means to turn off emergency lighting after hours via Underwriters Laboratories’ UL 924–listed bypass relay or similar means, while still allowing the emergency lighting to activate during loss of normal power. Coordinate after-hours switching with Judicial Council security requirements.
- b. Provide integral battery packs or connection to an uninterruptible power source for select lights in the vicinity of the generator, within the generator enclosure. Provide emergency lighting as required in chapter 15, Electrical Criteria.
- c. Coordinate all emergency egress lighting with current State Fire Marshal requirements. Comply with NFPA (National Fire Protection Association) 101, Life Safety Code, for illumination in stairwells.
- d. Comply with Federal Aviation Administration (FAA) requirements, if applicable. Locate the FAA lighting controls status panel in a 24/7 area. Plan for temporary FAA lighting and permitting when the building tops out. Confirm grounding and lightning protection. Confirm that FAA lighting is on emergency power.

DIVISION TWO: TECHNICAL CRITERIA

- 11 Architectural Criteria
- 12 Structural Criteria
- 13 Mechanical Criteria
- 14 Building Management System Criteria
- 15 Electrical Criteria

16 LIGHTING CRITERIA

- 16.A Objectives
- 16.B Lighting Criteria
- 16.C Lighting Strategies
- 16.D Lighting Controls
- 16.E Lighting Commissioning

- 17 Network and Communication Systems
- 18 Audiovisual Systems
- 19 Acoustical Criteria
- 20 Fire Protection Criteria

4. Courtroom Lighting

- a. Facial feature clarity is very important in the courtroom, except in the spectator area. Therefore:
 - Use a combination of direct and indirect lighting;
 - Avoid harsh shadows, whether from electric light or daylight; and
 - Minimize direct and reflected glare.
- b. Audiovisual (AV) presentations are common in courtrooms. Lighting must be flexible enough to allow for dimmed ambient light levels, with sufficient light for note taking. Lighting directly in front of a projection or video display shall be capable of being switched off for evidence display. For courtrooms with flat-screen monitors, ensure that light sources do not obscure the screen image. Provide multiple levels of switched and continuous dimming in all courtrooms. Do not combine lighting scene controls with AV system controls. The same principle of lighting control shall be applied in conference and training rooms equipped with projectors and flat-screen monitors.
- c. Diffused daylight (without direct sunlight penetration) is desirable but may not be possible in all spaces. Where daylight is available, provide mechanical shading devices capable of darkening but not blacking out the room. Because a direct view into the courtroom is a security concern, provide daylight by clerestories or skylights only, or provide fixed louvers or baffles that prevent unwanted angles of view from exterior locations. Do not use diffusing glass below 8' above finished floor for any glazing that can receive direct sunlight during any hours of courtroom occupancy. All exterior glazing into a courtroom is generally required to be bullet resistant for security, so daylight into courtrooms should be carefully evaluated against project budget constraints. Where daylight is unavailable, supplement general illumination with other wall lighting such as wall washers or sconces.

5. Lighting for General Open Areas and Private Offices

Office ceilings shall be suitable for indirect lighting or both direct and indirect lighting. As with other spaces, minimizing glare and maximizing luminaire efficiency are key considerations. Where the California Energy Code requires additional controls for daylight zones, dimming is preferred to multilevel switching or stepped dimming.

6. Lighting of Judges' Chambers

Judges' chambers have the same general illumination requirements as other offices. The chambers typically have several task areas. Provide supplementary dimmable overhead task lighting at the conference table.

7. Lobby Lighting

Lobby shape, size, and finishes vary at each facility. Select the most efficient source with good shielding to reduce glare. Luminaires shall be located at a reasonable height for easy maintenance, without the need to use scissor lifts.

8. Circulation Lighting

Circulation areas shall have even, diffuse illumination for wayfinding. Luminaire selection and location shall be coordinated with directional signage. Limited accent lighting may be used to assist in wayfinding.

Exit-stair lighting shall incorporate the use of luminaires with integral ultrasonic occupancy sensors for energy savings. Each project shall verify with the California State Fire Marshal the specific control scheme acceptable with regard to egress illumination.

9. Holding Area Lighting

For holding areas, select security-rated luminaires resistant to penetration, distortion, and contraband concealment. Characteristics may include but are not limited to continuously seam-welded and smooth corners, completely concealed hinges, hardened security screws, and inner and outer lenses rated for the level of security required per space. (See chapter 8, In-Custody Defendant Receiving, Holding, and Transport.)

10. High-Density File Lighting

Each row of file stacks shall have illumination from luminaires designed to provide high levels of uniform vertical illumination in a narrow space.

11. Transaction Counter Lighting

A glass or acrylic security barrier typically separates the public from staff in areas where public transactions occur. This barrier can create, from luminaires, reflections that can reduce visibility and the ability to view facial expressions and intent. Minimize reflections by limiting light output to horizontal work surfaces and using luminaires with a low surface brightness. A glass or acrylic barrier that is intersected by an 18" or greater soffit at the ceiling will help reduce reflections. Lighting layouts that are identical on both sides of the glazed material can also minimize reflections. Indirect or direct and indirect lighting shall be avoided under these conditions because the bright ceiling will be a source of reflected glare in the clear security barrier.

12. Restroom Lighting

Lighting at mirrors shall be sufficient to see without creating facial shadows. Select lighting positions in front of the user, such as cove lighting, sconces, or over-mirror lighting. Lighting shall be evenly distributed within the stall areas. Light-color-value wall surfaces are preferred over darker values. (Refer to table 16.3, Recommended Reflectance Levels.)

13. Service Area Lighting

Lighting for electrical and mechanical rooms, main distribution frame rooms, intermediate distribution frame rooms, janitor closets, and related areas shall consist of LED striplights with drop lenses, providing at least 5 percent up-light. Bare diode striplights shall not be used.

14. Below-Grade Vehicle Area Lighting

At judges' parking, loading, receiving, and central holding areas, uniform lighting without shadows shall provide visibility and coverage if security cameras are used.

16.D LIGHTING CONTROLS

1. General

- a. Lighting controls shall meet the requirements of the California Energy Code (Cal. Code Regs., tit. 24, pt. 6). Courtrooms typically have multiple zones of control. Use the least complex, most intuitive system that will provide the required functions. In courtrooms with four or fewer zones of control, where lighting can be controlled from one primary location with one or two additional three-way controls, standard wall box switches or dimmers shall be used at a minimum. In courtrooms with more than four zones of

DIVISION TWO: TECHNICAL CRITERIA

- 11 Architectural Criteria
- 12 Structural Criteria
- 13 Mechanical Criteria
- 14 Building Management System Criteria
- 15 Electrical Criteria

16 LIGHTING CRITERIA

- 16.A Objectives
- 16.B Lighting Criteria
- 16.C Lighting Strategies
- 16.D Lighting Controls
- 16.E Lighting Commissioning

- 17 Network and Communication Systems
- 18 Audiovisual Systems
- 19 Acoustical Criteria
- 20 Fire Protection Criteria

control or multiple control location requirements, or if a room can be subdivided into smaller rooms with movable partitions, provide a preset dimming system. Controls shall be located to be convenient to court staff but not accessible to the public.

- b. Integrated AV/lighting touchscreen controls shall not be used. Wall-mounted lighting control modules shall be provided. AV and lighting controls shall be designed to function independently. Where provided, a graphical user interface (GUI) shall be dedicated to the audiovisual system only. The GUI shall not be used to control any other system, such as the lighting system or the building management system (BMS).
- c. Courtrooms, jury assembly rooms, large training rooms, and the security operations center shall have dimmable lighting.
- d. Occupancy controls that provide vacancy sensing are required in most spaces such that lights within a space are turned on manually and then turned off automatically when the room is vacant.
- e. Demand response lighting systems, if considered for a project, shall be determined early in the design phase to coordinate required lighting specifications and lighting control systems.
- f. Interface between the centralized lighting control system and the BMS is required. See chapter 14, Building Management System Criteria, for more information.

2. Daylighting

- a. Daylight-responsive (daylight-harvesting) controls shall meet the minimum criteria established by the California Energy Code (Cal. Code Regs., tit. 24, pt. 6).
- b. In spaces with daylight, luminaires located in the primary and secondary daylighted areas shall be zoned separately from other luminaires.
- c. Unless it can be demonstrated that daylight illumination is insufficient between the vernal equinox (typically March 20) and the autumnal equinox (typically September 22 or 23), provide daylight harvesting controls. All luminaires connected to the daylight harvesting system shall use continuous dimming drivers.
- d. Low-end trim for dimming shall be between 1 and 10 percent; daylighting systems shall not turn luminaires completely off.
- e. Photosensors shall be filtered or calibrated to respond only to light in the visual range (no ultraviolet or infrared light) and adjusted for the human sensitivity spectral curve. Continuous dimming controls shall utilize a sliding set point algorithm. The design set point for daylight dimming shall be 1.5 times the nighttime measured light level. For example, if the electric lights alone provide 30 foot-candles (FC), the luminaires shall not start to dim until the combined daylight and electric light reach or exceed 45 FC (30×1.5).

3. Quality Control

Provide a written lighting control intent narrative that explains the lighting control systems in common language, for client review and response during each design phase, and revised for submittal as part of the contract documents. Selected control manufacturers shall be required to verify that their products, as submitted during the shop drawing phase, meet the control intent, or to indicate any exceptions and describe how they intend to satisfy the desired performance of their products. At minimum, the lighting designer shall provide a narrative about lighting control design intent for each type of space. This narrative shall include the sequence of operations.

16.E LIGHTING COMMISSIONING

Specifications shall include commissioning services to ensure that the building delivered at the end of construction has fully operational occupancy sensors, photocells, photosensors, and dimming systems that provide proper controls. Basic services shall include staff training for systems operation and troubleshooting. Commissioning shall comply with California Energy Code (Cal. Code Regs., tit. 24, pt. 6).

DRAFT

DIVISION TWO: TECHNICAL CRITERIA

- 11 Architectural Criteria
- 12 Structural Criteria
- 13 Mechanical Criteria
- 14 Building Management System Criteria
- 15 Electrical Criteria

16 LIGHTING CRITERIA

- 16.A Objectives
 - 16.B Lighting Criteria
 - 16.C Lighting Strategies
 - 16.D Lighting Controls
 - 16.E Lighting Commissioning
- 17 Network and Communication Systems
 - 18 Audiovisual Systems
 - 19 Acoustical Criteria
 - 20 Fire Protection Criteria

DRAFT

17

DIVISION TWO: TECHNICAL CRITERIA

NETWORK AND COMMUNICATION SYSTEMS

SECTION	TOPIC	PAGE
17.A	General Overview	17.2
17.B	Minimum Point of Entry (MPOE)	17.4
17.C	Distribution Pathways	17.11
17.D	Backbone Connectivity	17.14
17.E	Horizontal Connectivity	17.15
17.F	Administration and Verification	17.19
17.G	Network Architecture	17.20
17.H	Distributed Antenna System	17.24



Superior Court of California, County of Yolo
Woodland, CA
Fentress and Dreyfuss-Blackford

Effective technology systems are essential for daily courthouse operations. A technology program is required to be developed along with the architectural program. The designers, Judicial Council, and court advisory team shall determine what is to be provided throughout the court building.

17.A GENERAL OVERVIEW

1. Introduction

This chapter covers the requirements for network communication system and other communication systems within courthouse buildings. Simply defined, a network communication system is the convergence of building technologies over a network architecture and shared physical layer that support the transport of Internet Protocol (IP)-based communications signals. This best practice has been made possible by ever-increasing bandwidths and numerous refinements in networking transmission techniques, allowing information to be transported using Ethernet interfaces and IP-based technologies.

The purpose of the network communications technology design is to provide a basis for the development of a structured cabling infrastructure that supports a physically converged, logically segregated IP network solution. Implementing a converged network solution offers several identifiable benefits. Commercial benefits include a lower capital expenditure and a reduction in the cost for maintenance and support. Considering the network, convergence provides increased network availability, scalability, and functionality. In addition, environmental benefits result from the reduction in materials and the need for building utility support, such as power and cooling.

A technology program is required to be developed along with the architectural program. The technology program shall be predicated on the extent and complexity of the technology embedded in a new court building. These factors will be the basis for decisions related to the implementation of a unified communication system, a converged IP network, and the structured cabling system.

This chapter contains standards, criteria, and recommendations related to the following:

- Communications rooms, including architectural, electrical, mechanical, grounding, and bonding guidelines required to support infrastructure and equipment deployment.
- Distribution pathways to support the intrabuilding infrastructure.
- Communications backbone and horizontal connectivity distribution and the performance rating of the cable used to support the building utility services throughout the facility.
- Administration and verification with identification and testing of the communications infrastructure and system components.

2. Structured Cabling

The structured cabling goal is to provide a robust physical layer that supports high reliability, bandwidth capacity, and future flexibility to extend current and future technology services to each courthouse facility.

3. Network Architecture

The Judicial Council standard is for all IP traffic to traverse a single integrated physical network that is segmented into multiple subnetworks. Network segmentation can be accomplished in various ways; the specific design for each courthouse shall be predicated on the extent and complexity of the technology embedded in a new court building. Figure 17.1 provides a high-level view of the physical architecture of a typical courthouse network, including telecommunications rooms, backbone and horizontal structured cabling, and end-point devices. Though not intended to convey each component or the logical network design, this illustration should give the reader a visual reference of the components and how they interconnect.

See tool 3, Integrated Network Architecture, for the integrated network architecture diagram that illustrates the expected intelligent building systems under the unified communication system.

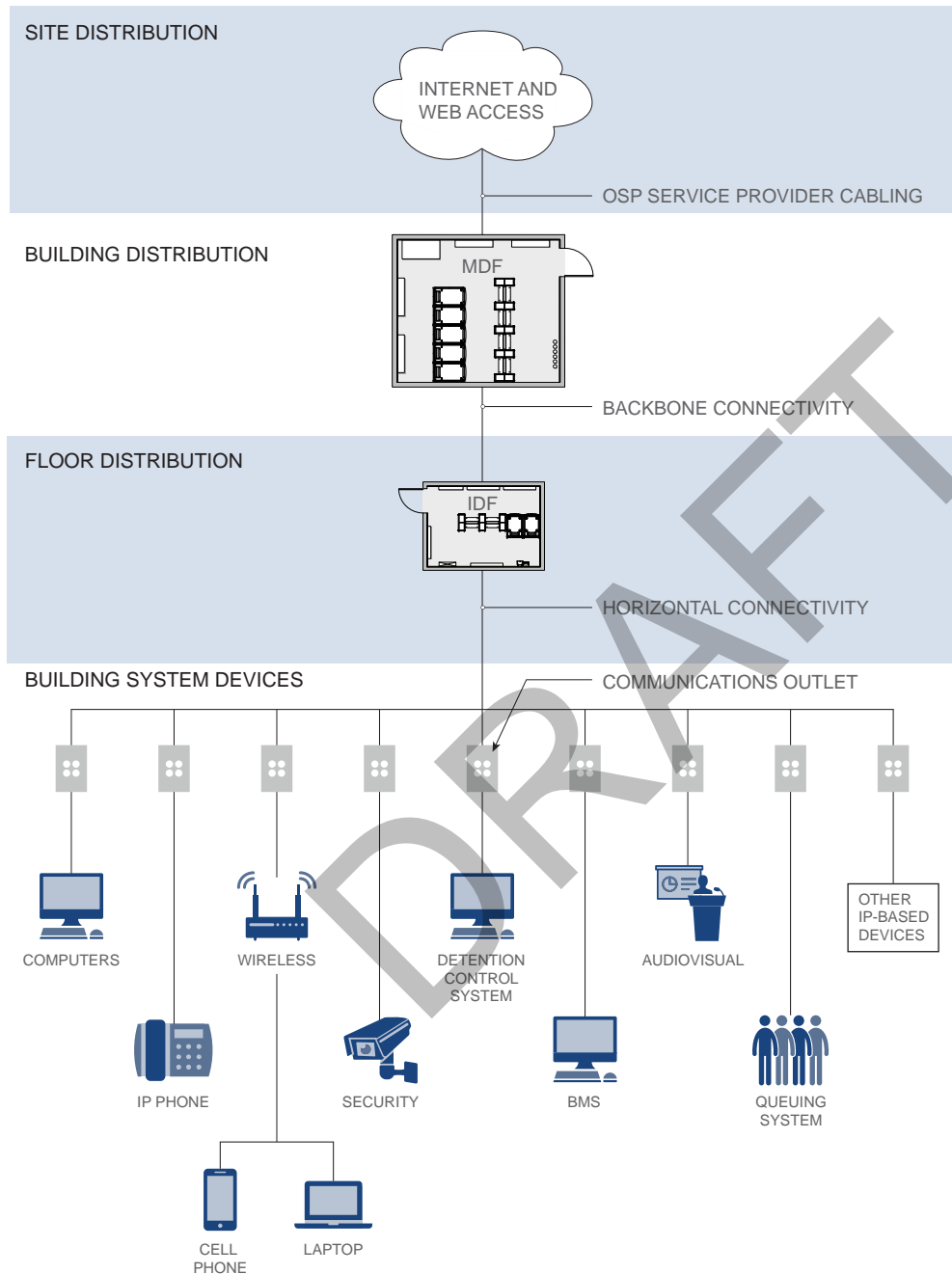

MDF = main distribution frame.
 IDF = intermediate distribution frame.
 BMS = building management system.

Figure 17.1 Layout Diagram of Structured Cabling Topology That Includes Building Systems

**DIVISION TWO:
 TECHNICAL CRITERIA**

- 11 Architectural Criteria
- 12 Structural Criteria
- 13 Mechanical Criteria
- 14 Building Management Systems Criteria
- 15 Electrical Criteria
- 16 Lighting Criteria

17 NETWORK AND COMMUNICATION SYSTEMS

- 17.A General Overview
- 17.B Minimum Point of Entry (MPOE)
- 17.C Distribution Pathways
- 17.D Backbone Connectivity
- 17.E Horizontal Connectivity
- 17.F Administration and Verification
- 17.G Network Architecture
- 17.H Distributed Antenna System

- 18 Audiovisual Systems
- 19 Acoustical Criteria
- 20 Fire Protection Criteria

Alternative Considerations

Colocating an IDF inside the MDF is an acceptable design practice.

For larger buildings that contain data centers, dual service entrance facilities shall be included to house multiple service provider termination components and equipment. All service entrance facilities should adhere to the requirements set out by the service providers. The physical entrance doors to these spaces shall be from within the building, with no doors opening directly to the exterior.

Related Reading

Chapter 20, Fire Protection Criteria, for fire suppression requirements

17.B MINIMUM POINT OF ENTRY (MPOE)**1. Telecommunications and Server Equipment Room**

The telecommunications and server equipment room (main distribution frame (MDF) room) must have a minimum of one-hour resistive construction. All walls (four sides) shall terminate at the structure above so a sealed enclosure is created. No intermediate ceiling is required. Adjoining rooms should not be restrooms or electrical, uninterruptible power supply (UPS), fire pump, switch gear, transformer, generator, or other high-combustible or high-fire-risk rooms.

2. Service Entrance Facilities**2.1 General Guidelines**

- a. An independent space, described as the service entrance facility, will be required within each court building to house service provider termination components and equipment or to serve as a splice point for incoming services.
- b. The placement of the entrance facility should be evaluated on a case-by-case basis considering location of service provider networks “in the street,” overall building size, and location of other building communications rooms. Whenever possible, collocate the entrance facility within the main distribution frame. Doing so minimizes the need to develop a separate, dedicated space.
- c. The entrance facility size and type should be developed considering overall building design, square footage of the facility, quantity of incoming conduits, and types of services required. A dedicated space within the entrance facility should be allocated to “stub out” conduit pathways. At a minimum, a 48” wide × 12” deep floor-to-ceiling space should be allocated on one accessible wall to support up to six conduits.

2.2 Design Criteria

- a. To simplify incoming conduit pathways, consideration should be given to locating the entrance facility on the basement level (if applicable) or the ground level and close to a load-bearing wall.
- b. Provide adequate overhead space for conduit pathways that either enter the room from outside the building or extend connections to the main communications space within the building.
- c. To accommodate cable pulling and apparatus, adequate clearance shall be provided in front of the wall where the conduits terminate.
- d. Vertical cable runway sections shall be used to route cables from the floor and ceiling conduit penetrations to the overhead cable runway.

3. Main Distribution Frame

This section refers to the MDF as a single space for space planning only. In practice, the MDF will be subdivided between various operational units allocating space for termination fields, active components, equipment cabinets, and relay racks required to house building communication system control devices. In simple terms, the MDF room will function as the main hub, or headend, within each courthouse facility. The MDF room size is determined by the amount of headend equipment in a particular court building. See table 17.1 for MDF space considerations.

Table 17.1 MDF Space Considerations

BUILDING TECHNOLOGY SYSTEM	TYPICAL MOUNTING LOCATION
Service Provider Fiber	2-Post Relay Rack
Service Provider Copper	Wall
OSP/ISP Building Fiber	2-Post Relay Rack
OSP/ISP Building Fiber	2-Post Relay Rack
OSP/ISP Building Copper	Wall
Vertical Cable Management	Sides of Each Relay Rack
IP Network Hardware	2-Post Relay Rack
Court Information Technology Servers	Equipment Cabinet
Audiovisual Systems	Equipment Cabinet
Security Access Control Panels	Wall
Security Servers	Equipment Cabinet
DAS Connectivity	Wall
DAS Radio and Cellular Components	Equipment Cabinet
BMS Servers	Equipment Cabinet
BMS Control Panels	Wall
Detention System Servers	Equipment Cabinet
Technician Desk	Floor (min. 4' wide × 5' deep)
Electrical Distribution Panel	Wall
Entrance Facility Conduits	Floor and Wall
Expansion Capability	25% Future Rack Space

OSP/ISP = outside plant / inside plant.
 DAS = distributed antenna system.

3.1 General Guidelines

- a. Provide a minimum of one MDF room per courthouse building, located on a lower floor, with an accessible pathway to the loading dock or freight elevator. The MDF shall not be located on any building exterior walls or below the flood level.
- b. A well-designed MDF is imperative to the overall success of the IP network and the technology systems that function within a courthouse facility. Figure 17.2 presents, for a smaller courthouse facility, a typical MDF layout that provides space for five equipment cabinets and four relay racks. The cold aisle is lined with the front sides of the server racks housing the cold air intakes, and hot aisles are where the hot air exhausts are located. The cold aisle should face the air-conditioning supply ducts, and hot aisles should face air-conditioning return ducts. Minimum clearances are indicated because they are critical to the functionality of all unified communications rooms and should be factored into the layout.

3.2 Design Criteria

- a. Cabinets and relay racks shall be EIA/ECA-310, ANSI/TIA-569, or IEC 60297-3-100 compliant with a standard height of 42U (rack units).
- b. No restrooms, janitor closets, or piping with running water shall be located immediately above, next to, or in the MDF.

**DIVISION TWO:
 TECHNICAL CRITERIA**

- 11 Architectural Criteria
- 12 Structural Criteria
- 13 Mechanical Criteria
- 14 Building Management Systems Criteria
- 15 Electrical Criteria
- 16 Lighting Criteria
- 17 NETWORK AND COMMUNICATION SYSTEMS**
- 17.A General Overview
- 17.B Minimum Point of Entry (MPOE)
- 17.C Distribution Pathways
- 17.D Backbone Connectivity
- 17.E Horizontal Connectivity
- 17.F Administration and Verification
- 17.G Network Architecture
- 17.H Distributed Antenna System
- 18 Audiovisual Systems
- 19 Acoustical Criteria
- 20 Fire Protection Criteria

Important References

An example of “active electronics” would be an information technology (IT) network switch used to connect local area network (LAN) segments.

Multiple courtrooms may be served from a single IDF; however, close coordination of the various technology systems space requirements is imperative when developing the overall size of an IDF supporting a courtroom space.

EIA/ECA = Electronic Industries Alliance Standards

ANSI = American National Standards Institute

TIA = Telecommunications Industry Association

IEC = International Electrotechnical Commission

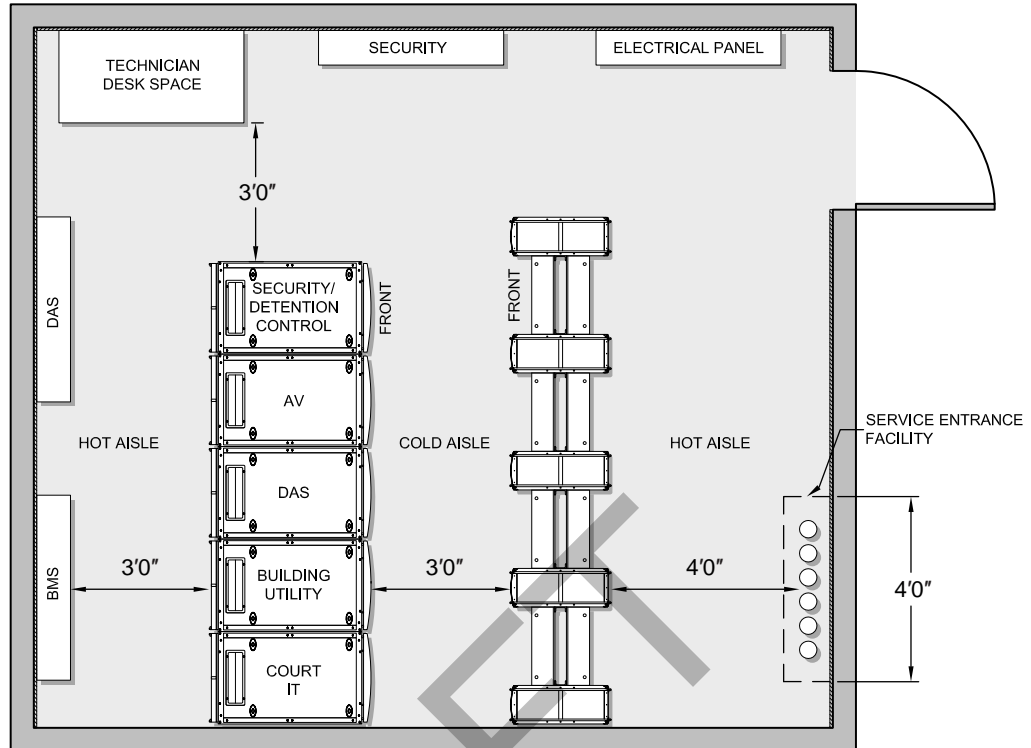

Figure 17.2 Typical Smaller Courthouse MDF Layout

- c. Internal wall surfaces should be covered with 3/4" fire-rated plywood. Sealed concrete is an acceptable finish on floors.
- d. Vertical cable runway sections should be used to route cables from the floor and ceiling conduit penetrations to the overhead cable runway.
- e. Outward swinging doors shall be provided and fitted with both a key and a card lock; the minimum door size should be 42" wide × 90" high.
- f. Floor loading should be factored at 200 pounds per square foot and confirmed on a case-by-case basis.
- g. A minimum of one relay rack should be reserved for the consolidation of service provider, county, and court wide area network (WAN) edge active equipment devices.
- h. At a minimum, use 10" × 17-1/2" double-sided vertical cable management between racks.
- i. Relay racks used for the termination of structured cabling should reserve 50 percent of the available rack unit space for active electronics.
- j. All equipment racks and cabinets shall be installed in compliance with California Building Code (CBC) seismic standards.
- k. Obtain typical power draw and National Electrical Manufacturers Association (NEMA) plug type for switches and UPS units. Include 208-volt outlets in the MDF/IDF (intermediate distribution frame) with 30 amp receptacles. Coordinate with site network requirements for additional power requirements.
- l. Develop the port count matrix early. Early involvement of the applicable provider is recommended.

- m. Calculate the estimated heat load of IDF/MDF for heating, ventilation, and air-conditioning (HVAC).
- n. Ensure the court data racks are next to the provider's data racks in an appropriately sized IT room.
- o. Provide a room-ready checklist in contract documents.
- p. See chapter 20, Fire Protection Criteria, for fire protection requirements for IDF/MDF rooms.

4. Intermediate Distribution Frame

An IDF is typically an enclosed architectural space for housing communications equipment, cabling terminations, and any cross-connect cabling required to distribute communications signals throughout a localized area.

4.1 General Guidelines

- a. IDF spaces should be dedicated to communication systems and audiovisual (AV) equipment use, centrally located on every floor, and stacked vertically through the building to enable efficient pathway and cabling distribution within each serving zone.
- b. IDF serving zones must allow for each individual twisted pair copper cabling segment to fall within the Ethernet distance limitations of 295'. Additional IDF spaces should be considered when the serving area is greater than 10,000 SF or the interior building space plan restricts the size of a single IDF, limiting the available space for equipment.
- c. Typically, IDF room size recommendations are derived from the square footages of the area served, factoring one outlet per typical 100 SF of work area. However, these general guidelines do not take into account the quantity of technology systems that courtroom IDF rooms are required to support; therefore, the general industry rule-of-thumb numbers should not apply. IDF rooms should be sized on a case-by-case basis considering the minimum clearances to accommodate the active electronics and termination components that each room houses.
- d. Table 17.2 outlines the systems and typical mounting locations that should be considered when developing the IDF size and interior design.
- e. Figure 17.3 presents a typical IDF layout for a courthouse facility where two courtrooms are served from a single IDF. This IDF provides two audiovisual cabinets (one per courtroom) and two relay racks for housing active electronics and structured cabling termination components. Minimum clearances are critical to the room design and are indicated for reference.

4.2 Design Criteria

- a. Cabinets and relay racks shall be EIA/ECA-310 or IEC 60297-3-100 compliant with a standard height of 42U.
- b. No restrooms, janitor closets, or piping with running water shall be located immediately above, next to, or in the IDF.
- c. Internal wall surfaces should be covered with 3/4" fire-rated plywood.
- d. Sealed concrete is an acceptable finish on floors, and a finished ceiling should not be provided.

**DIVISION TWO:
TECHNICAL CRITERIA**

- 11 Architectural Criteria
- 12 Structural Criteria
- 13 Mechanical Criteria
- 14 Building Management Systems Criteria
- 15 Electrical Criteria
- 16 Lighting Criteria
- 17 NETWORK AND COMMUNICATION SYSTEMS**
- 17.A General Overview
- 17.B Minimum Point of Entry (MPOE)
- 17.C Distribution Pathways
- 17.D Backbone Connectivity
- 17.E Horizontal Connectivity
- 17.F Administration and Verification
- 17.G Network Architecture
- 17.H Distributed Antenna System
- 18 Audiovisual Systems
- 19 Acoustical Criteria
- 20 Fire Protection Criteria

Table 17.2 IDF Space Considerations

BUILDING TECHNOLOGY SYSTEM	TYPICAL MOUNTING LOCATION
Intrabuilding Fiber	2-Post Relay Rack
Intrabuilding Copper	Wall
Horizontal Cabling	2-Post Relay Rack
Vertical Cable Management	Sides of Each Relay Rack
IP Network Hardware	2-Post Relay Rack
Audiovisual Systems	Equipment Cabinet
Security Access Control Panels	Wall
Security Servers	Equipment Cabinet
DAS Connectivity	Wall
BMS Control Panels	Wall
Detention System Servers	Equipment Cabinet
Detention System Control Panels	Wall
Electrical Distribution Panel	Wall
Vertical Conduit Pathways	Floor and Wall

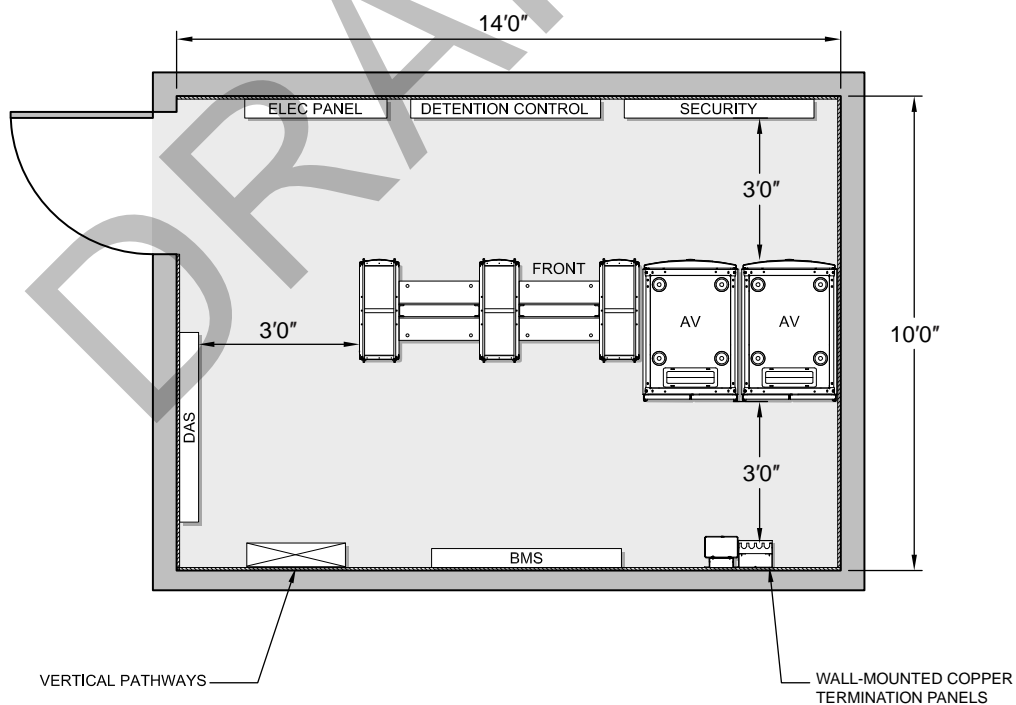

Figure 17.3 IDF Serving Two Courtrooms

- e. Vertical cable runway sections shall be used to route cables from the floor and ceiling penetrations to the overhead cable runway grid.
- f. A single outward swinging door should be provided and fitted with both a key and a card lock; minimum door size is 42" wide × 90" high.
- g. Adequate space and clearance should be provided for vertical conduit pathways.
- h. At a minimum, 10" double-sided vertical cable management between racks should be used.
- i. Relay racks used for the termination of structured cabling shall reserve 50 percent of the available rack unit space for active electronics.
- j. Equipment racks shall reserve 25 percent of the available space for additional equipment.
- k. All equipment racks and cabinets shall be installed in compliance with CBC seismic standards.

5. Electrical Systems

Although the main focus of this chapter is not the electrical system criteria, the technology systems located within MDF and IDF rooms have specific power requirements. Therefore, this section provides an overview of the specific MDF and IDF electrical needs that should be considered in the building-wide electrical design. Refer to chapter 15 for the full list of systems requiring backup generator power and independent UPS systems.

5.1 General Guidelines

- a. The full complement of technology-related systems housed inside MDF and IDF spaces should have adequate UPS power backup to support electrical interruptions for 90 minutes for non-life-safety equipment. The UPS shall not be connected to an emergency power system. A centralized UPS system is the preferred methodology for the distribution of short-term power when the main input power source fails. Among other things, this best practice provides benefits with increased space savings within the MDF and IDF rooms and reduces maintenance costs.
- b. All systems requiring generator power or dedicated UPS systems are defined in chapter 15. Refer to chapter 15 for details pertaining to fire-life-safety systems and non-life-safety systems and the specific requirements for each.
- c. During preliminary building design, load estimates are required to begin the electrical system design and for space planning. Although the actual electrical equipment loads are calculated once the final systems equipment is defined, general load estimates are provided as a basis for design. For detailed requirements of emergency and standby power systems, refer to chapter 15, Electrical Criteria.

5.2 Design Criteria

- a. Provide an overhead busway electrical distribution system within communications rooms. An electrical busway provides a more flexible power solution that accommodates a variety of receptacles and is more cost-effective over the life of the building.
- b. Provide a grounding circuit for communications equipment. Grounding and bonding shall be provided for all equipment and racks. A grounding bus bar shall be provided.

DIVISION TWO: TECHNICAL CRITERIA

- 11 Architectural Criteria
- 12 Structural Criteria
- 13 Mechanical Criteria
- 14 Building Management Systems Criteria
- 15 Electrical Criteria
- 16 Lighting Criteria
- 17 NETWORK AND COMMUNICATION SYSTEMS**
- 17.A General Overview
- 17.B Minimum Point of Entry (MPOE)
- 17.C Distribution Pathways
- 17.D Backbone Connectivity
- 17.E Horizontal Connectivity
- 17.F Administration and Verification
- 17.G Network Architecture
- 17.H Distributed Antenna System
- 18 Audiovisual Systems
- 19 Acoustical Criteria
- 20 Fire Protection Criteria

Coordinate with local service providers to determine specific pathway requirements or best practices.

Satellite pathway should be designed considering each courthouse facility's specific requirements.

Important References

ASHRAE Environmental Guidelines for Datacom Equipment

BICSI Telecommunications Distribution Methods Manual (latest edition) for separation information from electromagnetic interference sources and for pull-box sizing guidelines

Related Readings

Chapter 13, Mechanical Criteria

Chapter 15, Electrical Criteria

Chapter 16, Lighting Criteria

Chapter 20, Fire Protection Criteria

- c. Provide, in aiseways parallel to rows of racks and cabinets, lighting that does not conflict with the cable management infrastructure inside the rooms.
- d. Provide that lighting fixtures are not powered from the same distribution panel as are the room's power outlets.
- e. In-rack power distribution units (PDUs) shall be provided with power sources provided through the UPS system. Specific requirements for PDU sizes and load requirements shall be coordinated based on equipment requirements for each site.

6. Mechanical Systems

Although the main focus of this chapter is not the mechanical system criteria, the technology systems located within MDF and IDF rooms have specific mechanical requirements. Therefore, this section provides an overview of the specific MDF and IDF mechanical needs that should be considered in the building-wide mechanical design. Refer to chapter 13 for the building-wide mechanical systems design criteria.

6.1 General Guidelines

- a. Mechanical system cooling units shall be dedicated to the operation of the MDF and IDF rooms they serve and be located inside the room. Multiple floors shall have discrete service—that is, not be ganged together—and capable of providing 24/7/365 operation, independent of the “base building” system. System selection shall be either packaged heat pumps (condenser water) or fan coils (chilled water), based on case-by-case project analysis. Supply and return ducting shall be directed at the respective cold and hot aisle layout within each MDF and IDF room requiring cooling. Hot and cold aisles shall be fully contained such that hot aisle air does not interact with cold aisle air.
- b. At a minimum, the mechanical systems shall be designed to meet the current American Society of Heating, Refrigerating and Air-Conditioning Engineers Technical Committee's ASHRAE TC 9.9 thermal guidelines for allowable temperature and humidity parameters. For reference, the TC9.9 ASHRAE standard provides the following system parameters:
 - Low-end temperature: 64.4°F (Fahrenheit; supply air to equipment)
 - High-end temperature: 80.6°F (supply air to equipment)
 - Low-end moisture: 41.9°F dew point
 - High-end moisture: 60 percent relative humidity and 59°F dew point

Note: These recommended temperatures and conditions are for inlet air measurement entering the equipment and not necessarily room temperature.

- c. During preliminary building design, the estimated MDF room cooling load Btu/hr (British thermal units per hour) should be based on a minimum electrical load of 75 watts per square foot. In each IDF, the estimated cooling load (Btu/hr) should be based on a minimum electrical load of 65 watts per square foot. These load estimates should be developed further as the building design moves forward. The load shall be confirmed as equipment is determined and must meet or exceed the equipment manufacturer's requirements.

6.2 Design Criteria

- a. Consideration of air-side free cooling should be made based on climatic conditions.

- b. The mechanical systems shall report to the building management system (BMS), building engineers, and IT support personnel, triggering alarms when set parameters are exceeded.
- c. In general, avoid routing plumbing or HVAC pipes (pressurized or unpressurized) to go through any communications space. Water-filled pipes shall route around communications rooms rather than through them, unless they serve components within the room, such as fire suppression systems.
- d. When water-filled pipes travel within a communications room, pipe isolation and drain pans shall be provided.
- e. Roof drains or other sources of water shall not be located above any communications rooms.

7. Grounding and Bonding

- a. A uniform telecommunications grounding and bonding system shall be provided between all communications rooms in accordance with TIA/EIA 607-D telecommunications grounding and bonding standards and Building Industry Consulting Services International (BICSI) guidelines. The building-wide grounding system that provides each communications space with a dedicated grounding busbar shall comply with California Electrical Code (CEC).
- b. Extended from the grounding busbar within each communications space, a common bonding network consisting of a series of insulated stranded conductors, no less than 6 AWG (American Wire Gauge), should bond all communications components requiring a ground connection to the grounding busbar. Components typically bonded to the grounding busbar include, but are not limited to, equipment cabinets, relay racks, communications equipment, protector blocks, cable runways, and communications conduits.

17.C DISTRIBUTION PATHWAYS

To meet the overall goal of physical convergence, communications pathways should be designed to support the distribution needs of all unified communication systems. Combining low-voltage cabling infrastructure in shared pathways provides a well-organized, functional approach to the distribution of connectivity, whether outside or inside a courthouse building. In turn, a unified pathway design that takes into consideration the cable needs of each IP-based building technology enhances the flexibility of the distribution system over time, allowing for simplified changes or upgrades.

1. Outside Plant Pathways

In addition to the entrance conduits required for service provider connectivity, OSP pathways provide a means to route communications cabling outside the building. For a courthouse facility, this may include media connections to a television network pedestal, security entry control and camera devices, and landscaping control equipment. The OSP pathway system needs to be carefully coordinated with all site utilities. Industry standard components such as conduits, maintenance holes, pull boxes, or handholes should be used to distribute connectivity in the OSP.

1.1 Dedicated MPOE Conduits

Pathways and pulling points shall be dedicated to incoming service provider networks and not shared with other technologies or utilities. Diverse paths into the building should be considered and coordinated with the service providers.

**DIVISION TWO:
TECHNICAL CRITERIA**

- 11 Architectural Criteria
- 12 Structural Criteria
- 13 Mechanical Criteria
- 14 Building Management Systems Criteria
- 15 Electrical Criteria
- 16 Lighting Criteria
- 17 NETWORK AND COMMUNICATION SYSTEMS**
- 17.A General Overview
- 17.B Minimum Point of Entry (MPOE)
- 17.C Distribution Pathways
- 17.D Backbone Connectivity
- 17.E Horizontal Connectivity
- 17.F Administration and Verification
- 17.G Network Architecture
- 17.H Distributed Antenna System
- 18 Audiovisual Systems
- 19 Acoustical Criteria
- 20 Fire Protection Criteria

Alternative Considerations

Large multifloor facilities may be better served using second-level backbone cabling distribution—that is, a central IDF serving as a termination point for backbone connectivity from other IDF spaces.

For each project, the designer shall consider all building utility systems and verify the need for horizontal optical fiber media.

1.2 Service Entrance Conduit Quantities

The quantity of service entrance conduits should be based on the size of the facility, with a minimum of four 4" conduits, the service provider circuits, and the level of redundancy required. ANSI/CEC codes shall be used to determine quantities. Table 17.3 shall be used for general guidance. Entrance conduit routing should be developed with site utilities and local service providers to ensure that the property-line conduit termination points have been successfully coordinated.

Table 17.3 Guidelines for Service Entrance Conduit Quantities

NUMBER OF COURTROOMS	CONDUIT QUANTITY
1–6	4
7–19	6
20+	8

2. Inside Plant (ISP) Pathways

A well-designed ISP distribution system must allow for day-one capacity as well as the high likelihood of future modifications to provide numerous efficiencies over the life cycle of a building. The ISP pathways provide a means to successfully route and support all IP and non-IP low-voltage connectivity, including larger conduit pathways for backbone connectivity between communications rooms, smaller conduit pathways for horizontal connectivity extended to wall and floor communications outlets, and connectivity for devices using Power over Ethernet.

2.1 Backbone Distribution System

- a. From the MPOE, dedicated ISP conduit pathways shall extend to the MDF. When the service entrance facility is colocated within the MDF, conduit pathways shall extend directly from the OSP to the entrance facility space. An OSP-to-MDF conduit pathway system should be designed considering standard practices of the various service providers delivering connections to the building.
- b. The design of backbone pathways between communications rooms should factor together the many variables associated with connecting technology spaces. The standard practice is to provide conduit pathways between the main communications rooms. In cases where IDF rooms are stacked, locating pathways in the same place within each IDF is the preferred vertical distribution methodology. Provide a functional and flexible backbone pathway design—including access and clearance, appropriate bend radii, and pull boxes—to allow for the successful distribution of communications backbone cabling.
- c. The number of conduits per pathway varies depending on the number of communications cables. Provide a minimum 25 percent for future growth when considering the total quantity of conduits required. Backbone conduit segments that are greater than 50' should have fabric duct separators installed for the length of the conduit run. A maximum fill rate of 40 percent should be factored for day-one conduit capacity.

2.2 Rooftop Communications Systems

To facilitate future installation of rooftop communication systems, provide an electrical subpanel and submeter on the rooftop. Provide conduit pathways to the rooftop from the electrical room with pull rope (not pull string) to allow for cable runs to be added for future installations.

2.3 Horizontal Distribution System

- a. Horizontal distribution pathways designed to accommodate low-voltage cabling systems can be grouped into two preferred methodologies: the primary conveyance system, which is a cable tray that extends above the main corridors from the serving communications room, and the secondary conveyance system, consisting of conduit pathways from the cable tray to the communications outlet location. Coordination of each communications outlet location throughout the facility is critical, especially within the courtroom.
- b. Basket or solid-rail-style cable trays are required for courtroom buildings because of their elevated capacities, increased robustness, and accessory components used for separation of the non-IP cable bundles such as BMS, AV, and security cabling. Accessibility and clearance requirements should be coordinated so that the overall functionality of the conveyance system is enhanced. At a minimum, cable tray clearances of 12" above, 24" to one side, and 3" clear vertical space above ceiling tiles and supports should be provided.
- c. Conduit pathways used for horizontal distribution shall be designed to accommodate the quantity of cables they are required to support. Coordinating final outlet locations and pathway design factoring millwork and other interior architectural parameters is critical within every courtroom. The current minimum conduit size for a standard communications outlet is 1-1/4". Wall-mounted electrical back boxes should have manufactured 1-1/4" knockouts to accommodate the conduit.
- d. To minimize the overall number of floor penetrations, combined power and communications floor boxes and poke-through devices are acceptable for floor-mounted outlets. Size floor boxes and poke-through devices according to the number of low-voltage communications and electrical outlets at each outlet location. Specific attention should be given to floor depths and fire ratings when specifying floor boxes and poke-through devices.
- e. In addition to the conveyance systems, reenterable UL (Underwriters Laboratories)-rated fire-stop assemblies are required for through penetrations in all rated walls and floors. At a minimum, size the assembly considering UL and the manufacturer's allowable fill rate. Provide a minimum 25 percent for future growth when considering the total quantity of assemblies required.

2.4 Design Criteria

- a. Install conduit runs in lieu of cable trays where access to the cable tray is restricted for more than 10'.
- b. Locate conduit pull boxes in easily accessible locations.
- c. Install ground distribution pathways according to telecommunications industry standards.
- d. Insert conduit pull cords within the pathway to allow for future expansion.
- e. Include the cable tray size, location, and mounting methods in the building information modeling.
- f. Consider acoustical transfer of hard wall connection.
- g. Coordinate rated wall penetrations.
- h. Do not install cable trays above hard lids when possible.
- i. Use basket-type trays in lieu of rail type.

DIVISION TWO: TECHNICAL CRITERIA

- 11 Architectural Criteria
- 12 Structural Criteria
- 13 Mechanical Criteria
- 14 Building Management Systems Criteria
- 15 Electrical Criteria
- 16 Lighting Criteria
- 17 NETWORK AND COMMUNICATION SYSTEMS
- 17.A General Overview
- 17.B Minimum Point of Entry (MPOE)
- 17.C Distribution Pathways
- 17.D Backbone Connectivity
- 17.E Horizontal Connectivity
- 17.F Administration and Verification
- 17.G Network Architecture
- 17.H Distributed Antenna System
- 18 Audiovisual Systems
- 19 Acoustical Criteria
- 20 Fire Protection Criteria

Important Reference

The communication system should comply with ANSI/TIA/EIA 606-A, Administration Standard for Commercial Telecommunications Infrastructure.

- j. Include seismic support for weight.
- k. Include expansion percentage in specifications.

17.D BACKBONE CONNECTIVITY

As technology systems converge onto the IP network, efficiencies increase when a common backbone is used to distribute communications signals. Optical fiber cables shall be used as the primary backbone medium because they provide higher bandwidth and can extend greater distances than their copper counterpart. Multipair copper cabling has become the auxiliary backbone medium used to extend analog or non-IP signal technology.

Coordinate the backbone and horizontal connectivity needs for community antenna television (CATV) distribution on a case-by-case basis.

1. Optical Fiber

The current design base for first-level backbone connectivity, from the MDF to each IDF, is to deploy single-mode fiber (SMF) and 50/125 micron, laser-optimized multimode fiber (LOMMF). The fiber cable performance characteristics described below are provided considering these two fiber types. As network design evolves to meet growing bandwidth needs, the strand quantities and types of optical fiber provided in the backbone segment should meet current project requirements, industry standards, and projected bandwidth benchmarks. Reference ANSI/TIA-568.3-D for fiber installation standards and the National Electrical Contractors Association and Fiber Optic Association's NECA/FOA-301.

1.1 Single Mode

For single-mode fiber, OS2 fiber is the recommended cable type. Backbone SMF cable should be capable of 40-gigabit Ethernet signal transmission to 10,000 meters in the 1,310 nanometer (nm) operating window. Maximum attenuation for an SMF cable shall be no greater than 0.7 decibel (dB) per kilometer (km) using 1,310 nm and 0.5 dB/km using 1,550 nm wavelengths, respectively. Fusion-spliced, factory-connectorized pigtailed are the required termination practice for SMF cable. SMF cable between the MDF and each IDF shall have a minimum of 24 strands.

1.2 Laser-Optimized Multimode

For multimode fiber, OM4 is the recommended cable type. Laser-optimized multimode cables should be capable of 40-gigabit Ethernet signal transmission to 300 meters at 2,000 megahertz/km effective modal bandwidth. Maximum attenuation for LOMMF cable shall be no greater than 3.0 dB/km using 850 nm and 1.0 dB/km using 1,300 nm wavelengths, respectively. LOMMF cable between the MDF and each IDF shall have a minimum of 24 strands.

1.3 Cabling Criteria

- a. Provide a flexible, spirally wrapped interlocking armor over an individual jacketed and tight buffered cable.
- b. Terminate fiber cabling in fully enclosed fiber panels.
- c. Provide 25 percent spare termination capacity in the panel.
- d. Provide fiber connectors to be small-form-factor latched connector (LC) duplex.
- e. Provide connectivity to be rated per the installation environment.

2. Multipair Copper

2.1 General Requirements

Multipair copper cable should extend from the MDF to each IDF room. Select a voice-grade Category 5e unshielded twisted pair (UTP) ARMM (abrasion resistant millimeters) cable. Use a minimum of 25 pairs.

2.2 Cabling Criteria

- a. Terminate cabling onto a 110-type wall field.
- b. Provide 25 percent spare termination capacity.
- c. Connectivity shall be rated per the installation environment.

17.E HORIZONTAL CONNECTIVITY

Horizontal connectivity, from the floor serving IDF space to each communications outlet location, is required to extend service to various building system end devices that use the IP network. The transport medium most widely used in the “horizontal” is a twisted pair copper cable. Optical fiber cabling should be considered for outlet locations that are determined to be over distance.

Supplementing the hard-wired connections throughout the facility, a wireless local area network (WLAN) shall be included (when developing the technology program) to provide additional connectivity to court staff or court building users. An understanding of the connectivity requirements for each system should be realized at the earliest phases in the design process and include a site survey with heat maps to plan placement of WLAN access points to ensure even signal coverage and eliminate dead spots. WLAN connectivity shall be provided for all areas with computerized maintenance equipment, such as utility rooms in the basement and penthouse.

1. Four-Pair Copper

1.1 General Requirements

Provide an end-to-end solution based on ANSI/TIA-568.0-D or the highest performance standard ratified by ANSI/TIA/EIA for topologies, distances, installation, performance, and testing requirements for telecommunications structured cabling. The minimum standard for the horizontal permanent link cabling is 6A foiled, unshielded twisted pair (F/UTP) cable, otherwise known as augmented Category 6. A foil applied over unshielded twisted pairs shall be the minimum standard for jacketing of four-pair copper cables. As network bandwidth increases, the category performance rating of four-pair copper cable should be revised to meet current industry standards.

1.2 Cabling Criteria

- a. Each four-pair copper cable permanent link shall fall within the Ethernet distance limitation of 295’.
- b. The complete cable plant shall meet ANSI/TIA-1152, Level IIIe performance requirements for Category 6A cabling.
- c. In communications rooms, terminate the cabling in angled patch panels.
- d. The end-to-end, four-pair copper connectivity solution shall use shielded components, including faceplates, wall jacks, and patch cables.
- e. Connectivity shall be rated for the installation environment.

DIVISION TWO: TECHNICAL CRITERIA

- 11 Architectural Criteria
- 12 Structural Criteria
- 13 Mechanical Criteria
- 14 Building Management Systems Criteria
- 15 Electrical Criteria
- 16 Lighting Criteria
- 17 NETWORK AND COMMUNICATION SYSTEMS
- 17.A General Overview
- 17.B Minimum Point of Entry (MPOE)
- 17.C Distribution Pathways
- 17.D Backbone Connectivity
- 17.E Horizontal Connectivity
- 17.F Administration and Verification
- 17.G Network Architecture
- 17.H Distributed Antenna System
- 18 Audiovisual Systems
- 19 Acoustical Criteria
- 20 Fire Protection Criteria

Related Requirements

Tool 3, Integrated Network Architecture: LAN/WAN Diagram (Integrated Architecture Network Diagram)

Judicial Council LAN/WAN Architecture and Standards Document for IP network design principles and specific hardware elements

2. Wireless Local Area Network

Although the term wireless lends itself to the concept that hard-wired connections are not needed, a grid-type network of connection points dedicated to the wireless system is preferred, subject to confirmation by the technology program. To achieve seamless 100 percent coverage, communications outlets are placed in accessible locations, typically above suspended ceilings. These dedicated wireless outlets are considered part of the structured cabling system and are passive wiring-only locations, intended for use by active wireless devices, known as wireless access points (WAPs). WAP placement shall be determined through independent analysis via specialized testing and survey techniques (such as heat map or site survey) and shall be developed alongside the active systems network architecture design.

3. Typical Outlet Configurations

Typical configurations can be applied to the quantity of cables per outlet and the location of outlets per room or device. This practice is utilized early in design, so that the designer can begin validating architectural space planning efforts and develop device outlet layouts that are consistent with previous court projects.

Shown in table 17.4 is a matrix of typical communications outlets expected in a courthouse facility. The matrix illustrates the typical quantity of horizontal four-pair copper cables for each communications outlet adjacent to the IP port activation strategy. The quantity of IP port activations is provided factoring the various building system devices that may be deployed.

The standard outlet housing or faceplate shall have a minimum of four ports. All unused ports shall have a blank insert. A wall-mount phone faceplate is an exception.

Figure 17.4 and figure 17.5 identify the typical wall, floor, and future outlet locations within a typical courtroom.

Table 17.4 Communications Outlet Matrix

OUTLET TYPE	FOUR-PAIR CABLES	ACTIVE IP PORTS
Typical Office	3	2
Typical Systems Furniture	3	2
Typical Copier/Printer/Fax	2	2
Wireless Local Area Network Access Point	2	2
Digital Display	2	1
Audiovisual Projector	2	2
Elevator Control	1 (per elevator)	0
Wall Phone	1	0
Audiovisual Control Panel	1	0
Security Control Panel	2	2
Security Camera	1	1
BMS Control Panel	2	1
Intercom	1	1
Lighting Control Panel	2	1
Judge Position	3	3
Clerk	3	2
Court Reporter Position	2	2
Witness Position	2	2
Counsel Table	2	2
Lectern	4	4
Interpreters	2	2

**DIVISION TWO:
TECHNICAL CRITERIA**

- 11 Architectural Criteria
- 12 Structural Criteria
- 13 Mechanical Criteria
- 14 Building Management Systems Criteria
- 15 Electrical Criteria
- 16 Lighting Criteria

17 NETWORK AND COMMUNICATION SYSTEMS

- 17.A General Overview
- 17.B Minimum Point of Entry (MPOE)
- 17.C Distribution Pathways
- 17.D Backbone Connectivity
- 17.E Horizontal Connectivity
- 17.F Administration and Verification
- 17.G Network Architecture
- 17.H Distributed Antenna System

- 18 Audiovisual Systems
- 19 Acoustical Criteria
- 20 Fire Protection Criteria

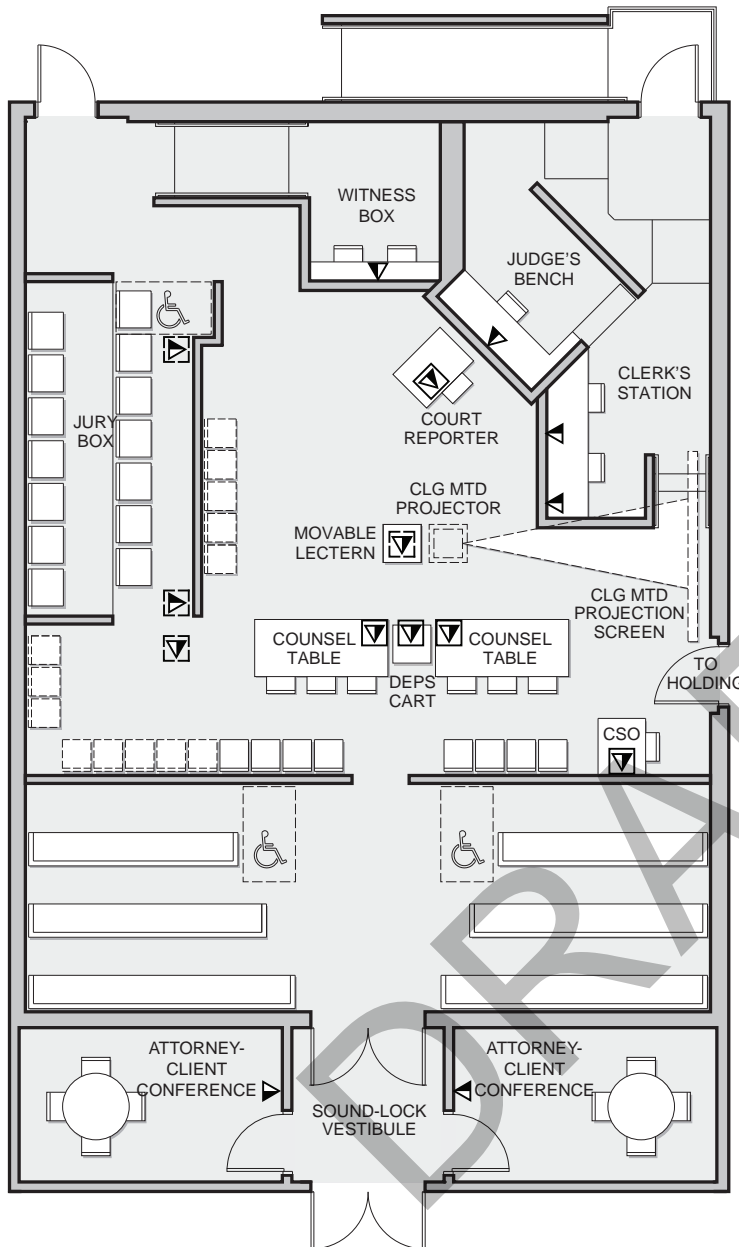

- ▼ WALL COMMUNICATIONS OUTLET
- ▣ FLOOR COMMUNICATIONS OUTLET
- ▣ FUTURE OUTLETS; PATHWAY ONLY



CLG MTD = ceiling mounted.
 CSO = court security officer.
 DEPS CART = digital evidence presentation system cart.

Figure 17.4 Multipurpose Courtroom With Corner Bench Showing Outlets

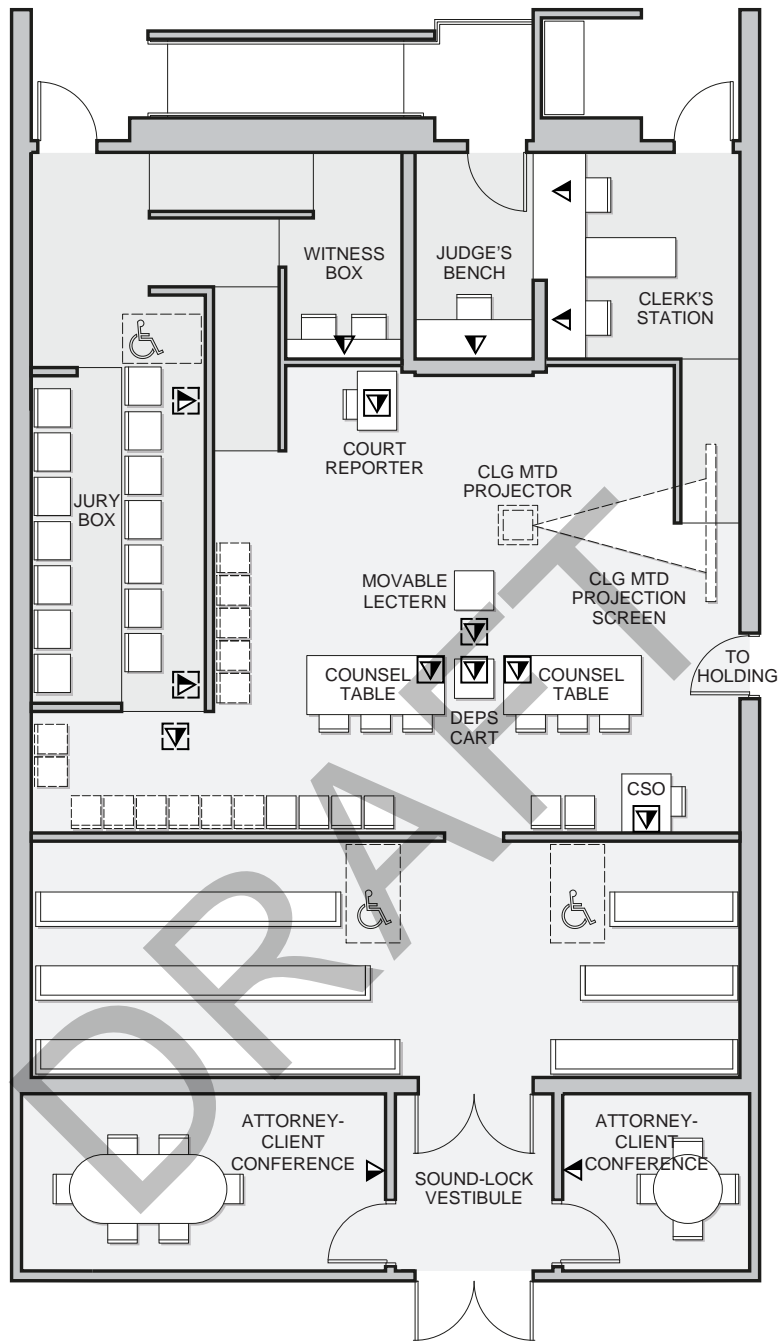

- ▼ WALL COMMUNICATIONS OUTLET
- ▣ FLOOR COMMUNICATIONS OUTLET
- ▣ FUTURE OUTLETS; PATHWAY ONLY

0 2' 4' 8' 12'

Figure 17.5 Multipurpose Courtroom With Center Bench Showing Outlets

17.F ADMINISTRATION AND VERIFICATION

Administration and verification of the structured cabling system are critical to the efficient functioning of a new courthouse facility through the design phase, construction build-out, and technology systems implementation either day-one or during the lifespan of the building.

Well-documented design processes—where detailed product information, shop drawings, and as-built drawings are submitted by the installing contractor—are project requirements and shall be strictly enforced. Project documentation of this type shall be reviewed in detail for accuracy and completeness.

The structured cabling connectivity solution shall be certified by the component manufacturers and provided with an extended minimum warranty period of 25 years.

1. Identification and Labeling

An identification system that complies with ANSI/TIA-606-C shall be implemented to uniquely identify the network infrastructure, including devices and cabling, installed in the facility. Provide a unique and consistent alphanumeric identification system to form the basis for the development of a communications administration system database to be approved before final design.

2. Connectivity Testing

A complete set of test results verifying the installed link and channel performance parameter results for all cable types shall be provided. Testing for copper cabling should be performed using, at a minimum, a level 4 testing device. For LOMMF cable, testing should be performed using fiber modules incorporating 850 nm vertical-cavity surface-emitting laser and 1,310 nm laser sources combined into a single output port. All testing should be performed in accordance with ANSI/TIA-1152 for copper testing and ANSI/TIA 568-C.0 and NECA/FOA-301 for fiber testing.

The test result documentation shall at a minimum contain testing, verification, and documentation of all performance specification parameters for the installed optical fiber and copper media. The documentation should be in both paper and electronic formats.

3. As-Built Documentation

As-built submittals should be developed in electronic format. At a minimum, the following documents should be provided (in addition to overall building as-built requirements):

- Project site plan of all OSP infrastructure with labeling and identification of each element
- Matrix of the communications cabling indicating type, location, splicing, physical routing, and quantities of all communications cabling
- Communications OSP cable plant test results
- Single-line diagrams showing connectivity throughout the OSP, including all splice and termination locations inside and outside the building
- Building floor plans showing communications outlet locations with identifiers for each cable
- Building floor plans showing communications outlet locations that indicate the quantity of active IP ports per location
- IP port activation matrix with per switch port to cable, to IP address, to virtual local area network (VLAN) identification

DIVISION TWO: TECHNICAL CRITERIA

- 11 Architectural Criteria
- 12 Structural Criteria
- 13 Mechanical Criteria
- 14 Building Management Systems Criteria
- 15 Electrical Criteria
- 16 Lighting Criteria
- 17 NETWORK AND COMMUNICATION SYSTEMS
 - 17.A General Overview
 - 17.B Minimum Point of Entry (MPOE)
 - 17.C Distribution Pathways
 - 17.D Backbone Connectivity
 - 17.E Horizontal Connectivity
 - 17.F Administration and Verification
 - 17.G Network Architecture
 - 17.H Distributed Antenna System
- 18 Audiovisual Systems
- 19 Acoustical Criteria
- 20 Fire Protection Criteria

- Building floor plans showing distributed antenna system (DAS) locations
- Enlarged plans of the communications rooms
- Heat maps for WLAN placement, with access point locations
- Building floor plans showing routing of communications pathways and pull-box locations
- Building floor plans showing locations and types of UL fire-stop systems
- Communications interior cable plant test results for copper and fiber
- Single-line diagrams of all components of the DAS, including infrastructure, connectivity, operating and safety devices, control panels, instrumentation, and annunciators

17.G NETWORK ARCHITECTURE

1. Design Principles

The converged IP network design's goal is to develop an intelligent, converged network that provides a responsive, effective, and supportive environment so the courts can achieve their communications network objectives.

A converged IP-based network provides an intelligent communications transport facility that is effective in increasing building performance, functionality, and environmental sustainability. Network convergence should allow the integration, automation, and optimization of all courthouse systems and equipment required to serve the building and its occupants.

Design principles that the integrated IP network should factor in include but are not limited to:

- Maximizing efficiency for occupants;
- Allowing effective resource management;
- Being responsive to user needs;
- The ability to adapt, integrate, and enhance new technologies;
- The ability to accommodate and react to organizational changes; and
- Ease of operation and maintenance.

2. Systems on the IP Network

The building systems communications goal is to employ IP devices so that they can be transported over the IP network. A converged IP network provides a single, logical transmission platform for all the IP devices within a facility.

Building systems connected to the IP network may require a temporary network for commissioning and testing purposes. Typically, the building IP network is one of the last systems to come online. For systems requiring commissioning and testing before network availability, the contractor shall provide a temporary network. Once the building IP network is live, a transfer to the permanent IP network can be made.

The following courthouse technology systems are typically supported by the facility’s converged IP network:

- Data for office applications
- Judicial-specific applications
- Case management systems
- Internet/Web access
- IP telephony system
- WLAN communications (Wi-Fi)
- Network management and network control traffic
- Security and access control systems
- Security video media
- Building management system
- Lighting control system
- Digital signage system
- Video and streaming media
- Audiovisual system
- Queuing system
- HVAC system
- Landscaping irrigation system
- Public address system

The technology program, which examines individual project needs and requirements, will determine which of the courthouse technology systems are needed and to what extent they will use the converged IP network.

3. IP Network Segregation

Table 17.5 documents the baseline network usage groups expected on the converged IP network that should be taken into account when designing IP network segregation (e.g., IP addressing and VLAN schemes).

4. Network Availability

- a. The primary design considerations of a high-availability network begin with the accumulation of information related to strategic business and system functionality requirements. After the primary information has been gathered, recommendations to achieve the required availability should be developed considering the latest communications technologies and converged network design principles.
- b. The following design parameters shall guide the design process through implementation, commissioning, and testing:
 - Scalability: Include switch port density in the LAN access and core/distribution layer, incoming service interface ports for WAN routers, and voice gateways.
 - Resiliency: Design the network with fault tolerance and/or fail-over capabilities to prevent system downtime resulting from a single point of failure.

DIVISION TWO: TECHNICAL CRITERIA

- 11 Architectural Criteria
- 12 Structural Criteria
- 13 Mechanical Criteria
- 14 Building Management Systems Criteria
- 15 Electrical Criteria
- 16 Lighting Criteria
- 17 NETWORK AND COMMUNICATION SYSTEMS**
- 17.A General Overview
- 17.B Minimum Point of Entry (MPOE)
- 17.C Distribution Pathways
- 17.D Backbone Connectivity
- 17.E Horizontal Connectivity
- 17.F Administration and Verification
- 17.G Network Architecture
- 17.H Distributed Antenna System
- 18 Audiovisual Systems
- 19 Acoustical Criteria
- 20 Fire Protection Criteria

Table 17.5 Network Segregation

SYSTEMS	SUBNET SEGREGATION	DEVICES
Data	Data (general user data traffic)	
	Data (printer)	
	Data (application server traffic)	
Voice	Voice over Internet Protocol (VoIP)	
	VoIP End Devices (handsets, etc.)	
	VoIP Call Management	
BMS	BMS IP Controller	
	BMS Servers	
	BMS Monitor Workstations	
Security—SMS	Security Management System (SMS)	Security IP End Devices
	SMS	Monitoring & Badge Workstations
	SMS	Access Control Servers
Security—DLCS	Detention Lock Control System (DLCS)	Intercom & Programmable Logic Controller
	DLCS	Monitoring Terminals
	DLCS	Detention Control & Intercom Servers
Security	Video Media	Security IP Cameras
	Video Media	Monitoring Workstations
	Video Media	Media Video Recording Servers
Security—Duress	Duress Alarm System	Duress Alarm Controller
Audiovisual	AV Control & Monitoring	AV IP End Devices
	AV Control & Monitoring	AV Matrix
	Digital Signage, Queuing & Internet Protocol Television (IPTV)	Display Panels
	Digital Signage, Queuing & IPTV	Media Servers
Wireless LAN	WLAN Trusted	
	WLAN Guest	
	WLAN Controller	
LAN to LAN	Routing LAN Core to LAN Core	
WAN Edge	Routing Edge Public Subnets	
Extranet	Extranet Clients	
Intrusion Detection System	Intrusion Prevention System Monitoring	
DMZ	Demilitarized Zone (DMZ) Subnets	
FW to Core LAN	Routing Firewall (FW) to Core LAN	
Network Management	Network Management	

- Redundancy: “Hot standby” redundancy (secondary paths) provides system resilience by delivering the capability to handle all the traffic and services of the primary system with minimal or no effect on the user base.
- Security: The relationship between network security and network availability is important. A network that has been compromised may not be available to its regular user base or may not achieve the expected performance or availability levels. Careful consideration is required when designing an environment where access to resources is restricted to users based on access lists, filtering, and passwords.
- Performance: Design criteria shall ensure the delivery of client-server-based applications, including interfaces and link data rates, quality of services (queuing, loss, latency, and jitter), and application characteristics.
- Manageability: System design shall allow administrators to be proactive when dealing with day-to-day operations. Management areas include device activity, bandwidth management, and software and system upgrades.
- Wireless: Design a converged network system to provide the user base with logical connectivity without being physically connected to the LAN infrastructure.
- Technology: A design consideration should be the adoption of open architecture standards-based communications and networking models to allow interoperability between existing systems and future system enhancements.
- Environmental: With the implementation of a converged network system providing business-critical availability, the need to protect the physical equipment environment becomes increasingly important. Environmental considerations typically include power, air-conditioning, and secure access.

5. IP Network Hardware Design Elements

- At the baseline level, the IP network hardware elements in table 17.6 shall be included in the design and integration of the converged IP network and WAN.
- Determine the type and capacity of IP network hardware elements needed on a per-project basis because the size of facility and number of active IP ports will vary significantly between projects. At a minimum, provide 25 percent IP port and switching throughput expansion capability for all LAN core and LAN access switches.
- The IP network hardware elements must be capable of accommodating the IP packet data traffic and IP device port needs of all the project-relevant building systems.

Table 17.6 IP Network Hardware Elements

WIDE AREA NETWORK	LOCAL AREA NETWORK
WAN Edge Routers or Switches	LAN Core Switches
Public Zone	LAN Access Switches
Firewalls	
Extranet Security Zone	
Demilitarized Zone	

DIVISION TWO: TECHNICAL CRITERIA

- Architectural Criteria
- Structural Criteria
- Mechanical Criteria
- Building Management Systems Criteria
- Electrical Criteria
- Lighting Criteria
- NETWORK AND COMMUNICATION SYSTEMS**
- A General Overview
- B Minimum Point of Entry (MPOE)
- C Distribution Pathways
- D Backbone Connectivity
- E Horizontal Connectivity
- F Administration and Verification
- G Network Architecture
- H Distributed Antenna System
- Audiovisual Systems
- Acoustical Criteria
- Fire Protection Criteria

Early determination and coordination of DAS requirements are required for MDF space planning and layout.

17.H DISTRIBUTED ANTENNA SYSTEM

1. Objectives

A distributed antenna system (DAS) is a network of spatially separated antenna nodes, connected via a transport medium, that provides radio and cellular wireless service throughout the facility. Because of the complexity of design factors related to developing an effective DAS, the extent of this system must be defined in the overall technology program.

A detailed court-by-court analysis is required for each facility to understand which service providers should be supported by the cellular DAS. In addition, coordination for the approval of interconnection to all the required service provider macro networks is necessary. This coordination effort will also need to be extended to public safety entities to accommodate the various frequencies that the emergency responder radio communication system (ERRCS) will support for emergency services and first responders.

2. General Requirements

Provide ERRCS per California Fire Code (CFC) chapter 510; National Fire Protection Association (NFPA) 72, chapter 24; and NFPA 1221, section 9.6. The provision of cellular DAS shall be determined on a project-by-project basis.

3. Public Safety

At a minimum, the public safety entities that should be considered during the design phase are the sheriff or marshal, fire and rescue department, emergency medical services, and any other first responders. A list of all entities and their associated frequencies must be captured under the primary public safety requirements of the DAS. The DAS should be flexible enough to allow for jurisdiction changes and for additional system frequencies. The radio frequencies for the court security provider personnel shall be included for in-building two-way radio communication.

4. Coverage Areas

Radio coverage is the primary concern, followed by cellular coverage for a courthouse building. Detention areas shall be provided with 100 percent radio coverage. Spaces including the fire command center, security operations center, fire pump room, judicial chambers, exit stairs, exit passageways, elevator lobbies, standpipe cabinets, sprinkler section valve locations, and all mechanical-room and communications spaces should have a minimum of 99 percent radio coverage.

Other general building area coverage should be within the allowable tolerance set by the Judicial Council and in compliance with CFC chapter 510; NFPA 72, chapter 24; and NFPA 1221, section 9.6 for ERRCS. It shall not fall below a minimum of 95 percent floor area radio coverage.

5. Space Requirements and Connectivity

If required, the DAS headend equipment, the base station, and other main components should be located within the MDF. If the MDF is used, then the space is required to be two-hour rated. There should be provisions within the MDF to support these components and space allocated for service-provider cabinets. Wall space should be dedicated within the MDF for DAS equipment panels and distribution equipment. All DAS equipment shall be placed in a NEMA 4 enclosure. Additionally, wall space in each IDF may need to be reserved to support DAS equipment and connectivity.

The DAS will use the building ISP fiber backbone. Any coaxial cable, splitters, or other DAS distribution media will need to be incorporated into the overall pathway and connectivity requirements. Where radio frequency-based technology requires the use of coaxial cable for horizontal connectivity, provide an RG-6 quad-shielded cable.

The ERRCS cabling shall meet code mandated survivability requirements.

6. Power

The power requirements for the DAS shall follow the CBC and CFC requirements. The DAS radio and cellular base station and other headend equipment must remain operational during a power outage. The source of uninterrupted power is project dependent and should be determined considering the independent needs of each courthouse facility. The ERRCS shall be provided with standby power per CFC 510.4.2.3 and 1203.2.3. Refer to chapter 15, Electrical Criteria, for detailed power requirements.

DRAFT

DIVISION TWO: TECHNICAL CRITERIA

- 11 Architectural Criteria
- 12 Structural Criteria
- 13 Mechanical Criteria
- 14 Building Management Systems Criteria
- 15 Electrical Criteria
- 16 Lighting Criteria
- 17 NETWORK AND COMMUNICATION SYSTEMS
 - 17.A General Overview
 - 17.B Minimum Point of Entry (MPOE)
 - 17.C Distribution Pathways
 - 17.D Backbone Connectivity
 - 17.E Horizontal Connectivity
 - 17.F Administration and Verification
 - 17.G Network Architecture
 - 17.H Distributed Antenna System
- 18 Audiovisual Systems
- 19 Acoustical Criteria
- 20 Fire Protection Criteria

DRAFT

DIVISION TWO: TECHNICAL CRITERIA

18

AUDIOVISUAL SYSTEMS

SECTION	TOPIC	PAGE
18.A	Audiovisual Design	18.2
18.B	Audiovisual Criteria	18.2
18.C	Technical Infrastructure	18.3
18.D	Audiovisual Systems Descriptions	18.3
18.E	Description of Courthouse Spaces	18.9

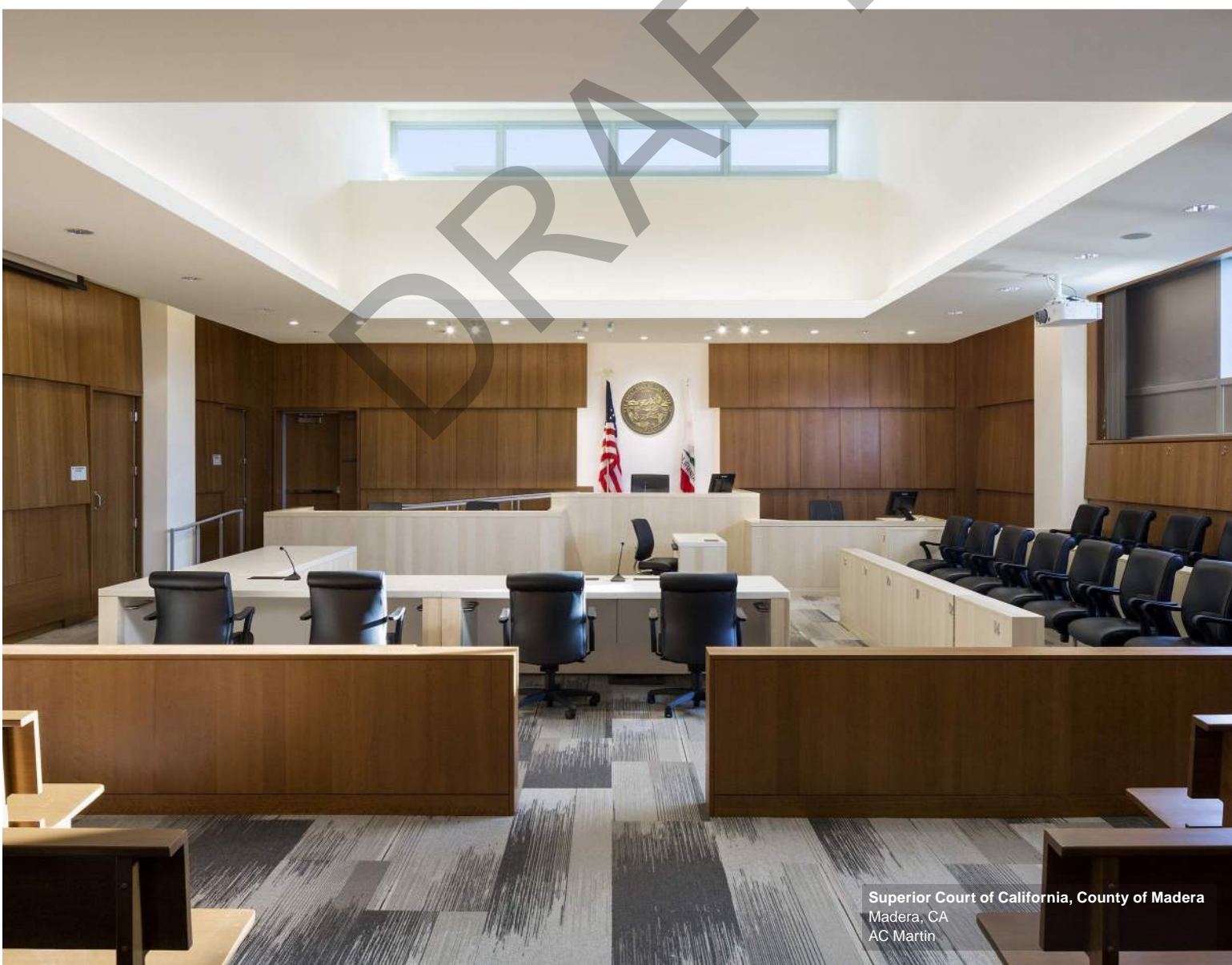

Coordinate with network and communication systems, mechanical, and electrical disciplines to ensure that adequate power, cooling, and network bandwidth are provided for all audiovisual systems components to run concurrently and at peak performance.

For further information, see chapter 13, Mechanical Criteria; chapter 15, Electrical Criteria; and chapter 16, Lighting Criteria.

Various configurations in the layout of courtrooms are driven by the function or functions assigned to their operation. Refer to chapter 5, Court Set, for layout descriptions.

18.A AUDIOVISUAL DESIGN

Audiovisual (AV) systems are part of the technology program to be implemented in the planning of the courthouse as described in chapter 17, Network and Communication Systems.

The design shall provide an integrated, reliable, scalable, and sustainable audiovisual system to assist the courthouse with judicial proceedings and day-to-day administrative and training needs. Systems shall be easy to use and maintain, regardless of the size and location of the facility or the number of staff employed.

18.B AUDIOVISUAL CRITERIA

The following criteria shall be followed when designing the audiovisual systems.

1. Reliability and Serviceability

Systems with a high level of reliability and ease of maintenance shall be chosen by implementing industry standard technologies and installation practices, as well as using readily available components and materials. All equipment specified must be available from at least two vendors.

2. Integration

- a. System components and infrastructure shall be fully integrated within the design of the courthouse. Equipment and cable management systems that allow for incorporation into the architectural elements, millwork, and furniture shall be selected. An effort shall be made to conceal equipment from plain sight.
- b. Audiovisual systems shall be integrated with the telecommunications and information technology (IT) systems to gain efficiency within the building design. Whenever possible, AV and network spaces, pathways, components, and cabling shall be shared. Where applicable, the AV system shall also use the IT systems for the delivery and transmission of audio, video, and control signals.
- c. All nonuser-interface AV equipment shall be installed in dedicated equipment cabinets located in the facility's main distribution frame (MDF) and intermediate distribution frame (IDF) locations. Only user essential equipment shall be installed in individual rooms. See chapter 17, Network and Communication Systems, for specific equipment criteria.

3. Scalability

A system that is nonproprietary, standards based, and scalable to allow for the future addition of components and functionality shall be chosen. The system components and technical infrastructure shall provide for a minimum of 15 percent expansion capability.

4. Sustainability

The designer shall provide a system designed to use environmentally conscious technologies, installation approaches, and power management strategies to reduce the impact on the building's electrical and mechanical systems and to promote overall facility efficiency. Whenever possible, the designer shall specify Energy Star-compliant components.

18.C TECHNICAL INFRASTRUCTURE

Figures 18.1 and 18.2 illustrate the distribution of technology elements in the courtroom. Wherever possible, colocate audiovisual services with the network infrastructure. See chapter 17, Network and Communication Systems, for coordination information.

1. Equipment Cabinets

Unless otherwise noted, all nonuser-interface AV components shall be installed in dedicated equipment cabinets located in the facility's MDF and IDF locations. If AV equipment is located in rooms other than IDF or MDF rooms (e.g., conference room credenzas), provisions must be made to supply adequate cooling air to keep the temperature below the manufacturer's rating, even when the building-wide air-conditioning system is in unoccupied mode during nights and weekends. Equipment racks must include all cable management, electrical power distribution, blanks panels, vent panels, and the like. See chapter 17, Network and Communication Systems, for specific equipment cabinet size criteria.

2. Cable Pathways

Where industry best practice allows, the audiovisual cabling shall use the telecommunications pathway infrastructure. Careful planning and design shall be observed to avoid signal cross-contamination. Where Ethernet cable is used, no horizontal AV pathway initiated at the MDF or IDF shall exceed the distance limitation of 295'.

18.D AUDIOVISUAL SYSTEMS DESCRIPTIONS

1. Speech and Audio Reinforcement System

- a. Wired microphones shall use shock and vibration isolation mounts, mute switches, and illuminated mute lights. Radio frequency (RF)-based wireless microphones shall use digital encryption.
- b. When RF-based microphones are used, the designer shall conduct radio frequency sweep tests to ensure that correct allocation and sufficient bandwidth are available.
- c. In courtroom applications, audio-processing systems with 8 to 12 digital recording outputs and 4 mix-minus speaker zone capabilities shall be provided. The systems shall also provide sound-masking capabilities, or pink noise, to impair the hearing of courtroom participants while confidential conversations are being held between an attorney and the judge at the judge's bench. The clerk's and court reporter's stations shall have mixed-audio output connections.
- d. Speech and audio reinforcement systems design and final commissioning shall follow the current release of the design standards established by AVIXA A102.01:2017, Audio Coverage Uniformity in Listener Area.

2. Assistive Listening

An assistive listening system shall provide secure transmission of both speech and program audio to participants or members of the public. When evaluating the types of assistive listening systems in the design as well as the quantities of headsets, refer to sections 11B-219 and 11B-706 of title 24 of the California Code of Regulations to ensure adequate provisioning.

DIVISION TWO: TECHNICAL CRITERIA

- 11 Architectural Criteria
- 12 Structural Criteria
- 13 Mechanical Criteria
- 14 Building Management System Criteria
- 15 Electrical Criteria
- 16 Lighting Criteria
- 17 Network and Communication Systems

18 AUDIOVISUAL SYSTEMS

- 18.A Audiovisual Design
- 18.B Audiovisual Criteria
- 18.C Technical Infrastructure
- 18.D Audiovisual Systems Descriptions
- 18.E Description of Courthouse Spaces

- 19 Acoustical Criteria
- 20 Fire Protection Criteria

Refer to chapter 10, Building Support Services, for additional information.

MDFs and IDF are integral parts of the audiovisual system's backbone. Close coordination with the network, mechanical, and electrical infrastructure systems is necessary to ensure successful audiovisual technology deployment. Refer to the corresponding chapters for more information.

Network pathways play a key role in the routing and distribution of cables for many of the building technology systems. The sharing of these pathways with audiovisual systems is encouraged. Refer to chapter 17, Network and Communication Systems, and chapter 15, Electrical Criteria, for standards and procedures.

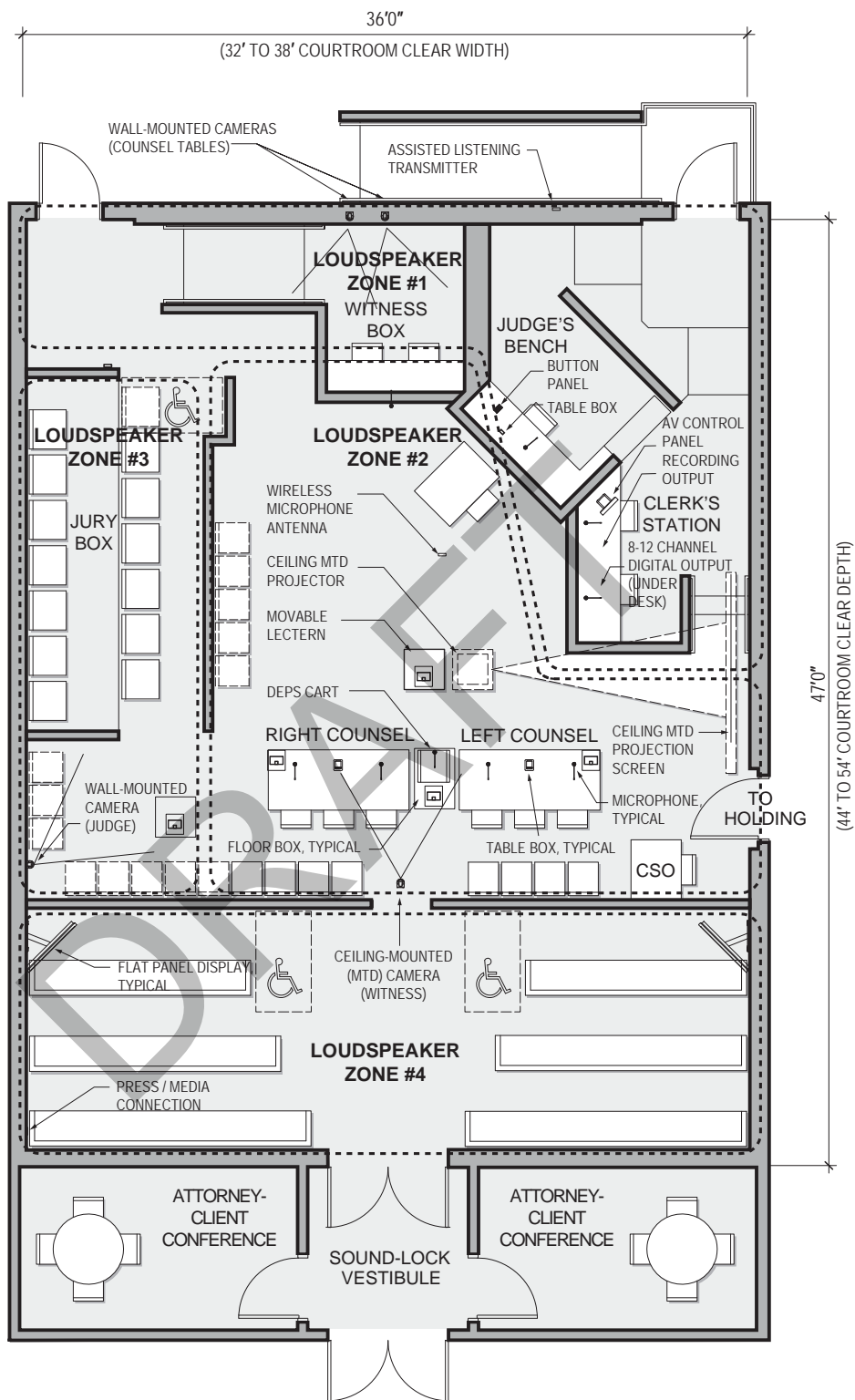

CSO = court security officer.

DEPS cart = digital evidence presentation system cart.



Figure 18.1 Typical Courtroom, Corner Bench—AV Requirement

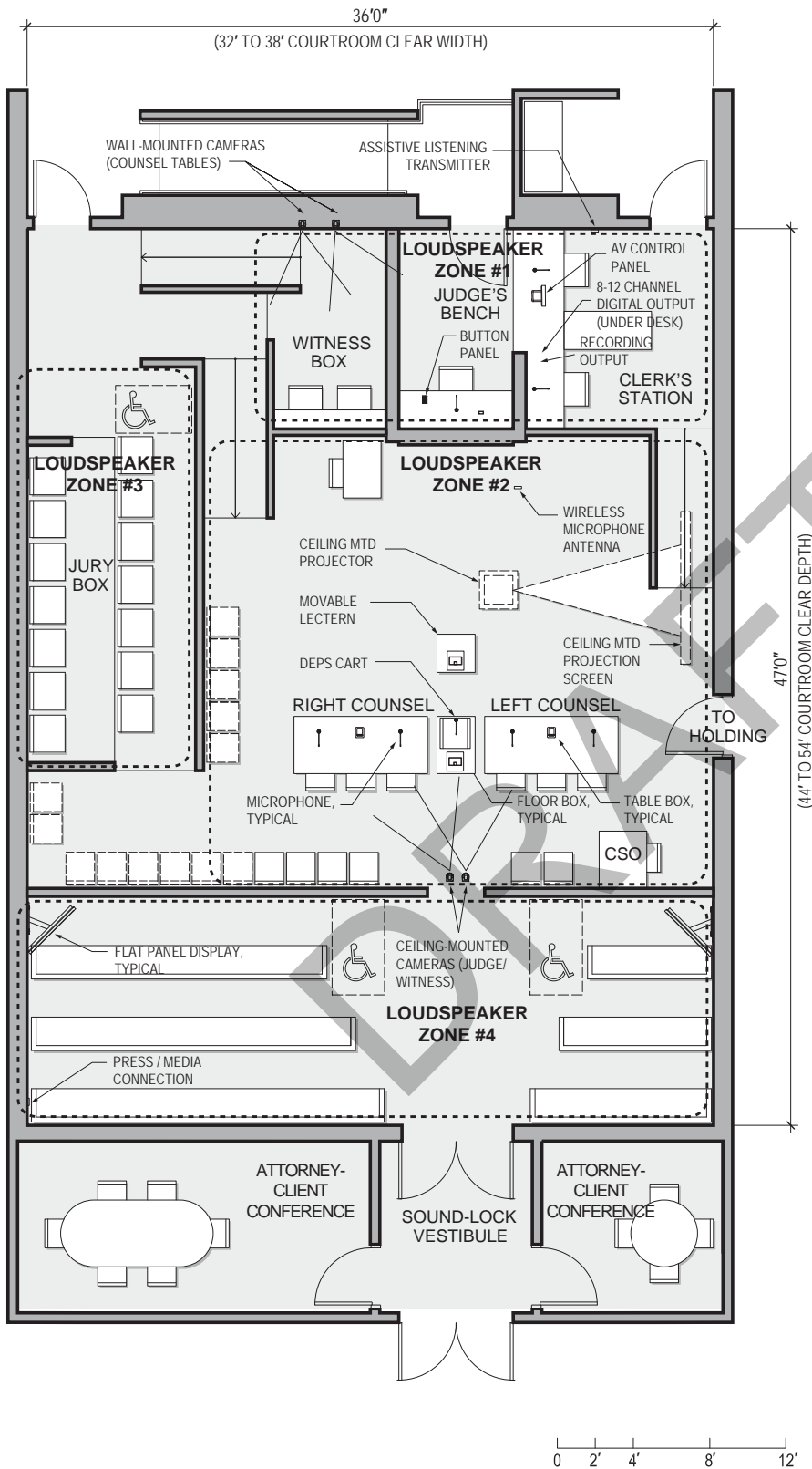

**DIVISION TWO:
TECHNICAL CRITERIA**

- 11 Architectural Criteria
- 12 Structural Criteria
- 13 Mechanical Criteria
- 14 Building Management System Criteria
- 15 Electrical Criteria
- 16 Lighting Criteria
- 17 Network and Communication Systems

18 AUDIOVISUAL SYSTEMS

- 18.A Audiovisual Design
- 18.B Audiovisual Criteria
- 18.C Technical Infrastructure
- 18.D Audiovisual Systems Descriptions
- 18.E Description of Courthouse Spaces

- 19 Acoustical Criteria
- 20 Fire Protection Criteria

Figure 18.2 Typical Courtroom, Center Bench—AV Requirement

Speech and audio reinforcement systems shall amplify program audio and enhance the voice of the speaker to ensure that all participants can adequately hear the material being presented.

Speech reinforcement loudspeakers shall be ceiling mounted and zoned appropriately for the application. Loudspeakers shall be distributed to provide even coverage throughout the space.

Pink noise is the sound-masking criterion.

3. Language Access

The language access system shall work in conjunction with alternate channels of the assistive listening system to provide for live interpretation to participants and audience members in courtrooms. Language access may be provided in other spaces as required on a per-project basis.

4. Video Display

Video display systems that will ensure that all participants can adequately view presented material on a common display shall be provided. The display can be either a projector with a motorized screen or a flat panel.

5. Digital Evidence Presentation System (DEPS)

The DEPS is an additional input to the courtroom video display. It is located between or in front of the attorney's tables, or in front or to the side of the courtroom clerk's desk. It is a neutral location for the display of evidence, which can be used by either attorney. Source content may include audio and video playback devices, laptops, and document cameras. Annotation of digital evidence capability is required. The document camera shall support annotation of digital evidence with functionality of saving digital formats of the annotated evidence and well as sharing the annotated evidence through the videoconferencing system. The system may be portable or dedicated, depending on courthouse needs. A DEPS cart shall be provided for each Courtroom.

6. Videoconferencing and Remote Appearances

The videoconferencing systems in the courthouse enable real-time communication between two or more locations, including locations of remote interpreters, conference rooms, training rooms, remote holding facilities, and remote locations.

In hybrid courtroom applications, the design shall include the use of a rack-mounted computer or small-scale personal computer. The use of a rack-mounted computer or small-scale personal computer will allow for the courtroom to operate any web-based videoconferencing platform. The rack-mounted computer shall be integrated with the touch panel for control of the videoconference platform through the touch panel controls. Audio and video shall be connected to the rack-mounted computer via USB connection.

Audio from the courtroom shall be routed through the DSP to the rack-mounted computer via USB and any corresponding converting equipment required. Audio from the rack-mounted computer shall be routed through the digital signal processing (DSP) cable to the courtroom house speaker system.

The video feed shall be transmitted through the video control switcher to the rack-mounted computer via USB and any required conversation equipment. Four fixed cameras shall be positioned to provide a clear view of the judge, litigants, and their attorneys, but not of the members of the jury. Multiple cameras and views will be needed for all courtrooms. Camera control shall be on the touch panel with pre-set camera views for convenience, not to exclude manual zoom controls of the camera. In cases with multiple cameras, camera selection shall also reside on the touch panel. In addition, multiple split camera views, either multiple 2:1 or 4:1 single camera views, will be needed to feed a single video feed with all camera views into the videoconferencing platform.

The desktop view of the rack-mounted computer shall be transmitted to the display and projector in the courtroom (or multiple locations). A wireless keyboard and mouse shall be provided to control the rack-mounted computer. USB extenders may be needed depending on the distance of the courtroom to the rack AV equipment (IDF room). Routing of the

rack-mounted computer to the courtroom display and projector shall be sourced at the touch panel.

Easy-access mute controls shall be required on the touch panel, including mute control for all video and audio into the courtroom, mute control for audio out to the far-end, and mute control of incoming audio. Digital evidence and annotation devices such as the document camera shall have the ability to share content through the videoconferencing system for remote viewers' ability to view digital evidence.

7. Control System

- a. Provide a control system for the management, monitoring, operation, and notification of local and facility-wide audiovisual equipment.
- b. The control system shall be designed to use the network infrastructure for the distribution of commands and data.
- c. Control systems provide simplified means of managing the functions of the audiovisual operations of the facility. All control system user-interface devices shall meet the requirements as stated in the Division of the State Architect (DSA) access compliance requirements of the California Building Code.

8. Control System Requirements

- a. Before starting the design of the touch panel graphical user interface (GUI), obtain the template for a typical courtroom design from the Judicial Council.
- b. Conduct a GUI coordination meeting with the court and the Judicial Council to determine if the court has a preferred approach, and select an approach.
- c. Based on the selected approach, customize the design to conform to the requirements of this project, and submit a set of screen shots for the most complex courtroom design. Explain if a single button performs multiple functions (e.g., partition sensors, teleconference in progress, fire alarm signal, shared resources being used).
- d. Once comments on the courtroom GUI have been incorporated, revise and resubmit the GUI to include the remaining spaces within the courthouse that use AV control systems.
- e. Once the comments on the complete GUI design have been approved, write processor code to operate the GUI (but not the actual controlled devices). Load it into a processor on the internet, and submit the appropriate files necessary to simulate the actual operation of the touch panel on a computer using a mouse.
- f. If the functioning GUI has been approved, proceed with the installation.

9. Touch Panel Design

- a. See tool 4, Graphical User Interface Template, for the touch panel template.
- b. All panels are to have the time and date displayed in the same position on every page.
- c. All pages are to have a title, indicating the piece of equipment and/or functionality being controlled.
- d. Each individual room type shall be given the same user interface design and layout throughout the project, to the greatest extent practicable.
- e. User interface design shall be as consistent as possible, taking into account the variations in system functionality from room type to room type, throughout the project.

DIVISION TWO: TECHNICAL CRITERIA

- 11 Architectural Criteria
- 12 Structural Criteria
- 13 Mechanical Criteria
- 14 Building Management System Criteria
- 15 Electrical Criteria
- 16 Lighting Criteria
- 17 Network and Communication Systems

18 AUDIOVISUAL SYSTEMS

- 18.A Audiovisual Design
- 18.B Audiovisual Criteria
- 18.C Technical Infrastructure
- 18.D Audiovisual Systems Descriptions
- 18.E Description of Courthouse Spaces

- 19 Acoustical Criteria
- 20 Fire Protection Criteria

An MDF is a space in which the core technology of the facility is concentrated. An MDF serves as a central point for the distribution of various subsystems that are part of the overall technology of the facility. Refer to chapter 17, Network and Communication Systems, for additional information.

See chapter 11, Architectural Criteria, for rooftop equipment information.

- f. Whenever the same button appears on more than one page, it must be in the same position on each page. This includes buttons that cause page-to-page flips.
- g. Functions used during a general presentation shall be accessible with a minimal amount of button presses or page flips.
- h. The sidebar and mute buttons from the judge's button panel shall also appear on every touch panel page.
- i. Individual microphone volume controls should not be on the main control page but should be on a setup page, to reduce clutter.
- j. Include the capability for automatically powering down all nonessential equipment supporting each individual room at a preset time (e.g., 6 p.m.) each day. Provide that the time can be set by the user on the room page, with an override valid for one day and the automatic power down restarting the next day. Play an audible sound from the touch panel one minute before automatic power down occurs, and allow the operator to override this function.

10. Television (TV)

Infrastructure to feed TV signals to desired spaces within the courthouse shall be provided. TV is usually viewed in the jury assembly room, employee break rooms, and some conference rooms. If the court has a contract with cable or satellite TV companies, provide the cabling and infrastructure to support this service. If the court wishes to view free, over-the-air TV, provide a roof-mounted antenna and tuners at the desired locations.

11. Provisions for Video Remote Interpreting

Provide the infrastructure to support video remote interpreting (VRI) in courtrooms either through the court's videoconferencing system or through the use of third-party videoconferencing software platforms (e.g., Zoom, Cisco Webex) that can be hosted on the videoconferencing system. When conducting VRI, the equipment and technology must provide high-quality communications, regardless of the physical location of the participants, so that all participants can be seen and heard whenever possible. See *Recommended Guidelines and Minimum Specifications for Video Remote Interpreting (VRI) for Spoken Language-Interpreted Events* (<https://www.courts.ca.gov/documents/vri-guidelines.pdf>) and *Recommended Guidelines for Video Remote Interpreting (VRI) for ASL-Interpreted Events* (<https://www.courts.ca.gov/documents/CIP-ASL-VRI-Guidelines.pdf>). VRI is generally preferred over telephonic interpreting, which does not provide visual cues. Several third-party videoconferencing platforms provide options for confidential conversations with the litigant, attorney, and interpreter. Also, these platforms may provide options for simultaneous interpretation, consecutive interpretation, and sight translation of documents. Some platforms, like Zoom and Webex, have a built-in simultaneous interpretation feature (i.e., separate audio channel).

12. Digital Signage and Customer Flow Management

The digital signage system consists of video displays and signal transport methods capable of accepting and displaying information from local or remotely generated video content sources and software. Digital signage is used for wayfinding, display of the court calendar, and other visual messaging as required by the facility.

Customer flow management (CFM) systems direct the flow of customers in waiting areas for a service provided at the facility. The system consists of customer intake, printing of queue tickets, sending of SMS (short message service) texts to court users' personal devices, and visual and audible announcements of the queuing process.

- a. In the waiting area, provide a minimum of one video display and speaker that are visually accessible to the public. Signal transport and system requirements shall be coordinated during the design phase.
- b. Video displays shall be integrated with the architecture of the building to allow for adequate technical infrastructure, cooling, ventilation, and future display hardware upgrades. See chapter 11, Architectural Criteria, for signage information. Digital signage systems may be interconnected to the court case management system and the CFM system to provide additional layers of information to the public specific to court proceedings, directories, and individual courtrooms.

18.E DESCRIPTION OF COURTHOUSE SPACES

1. Overview

Provide a turnkey audiovisual system—to include equipment and material, with associated labor, whether specifically mentioned herein or not—to ensure a complete working system that meets the needs of the court.

2. Typical Courtrooms

- a. Provide a sound reinforcement system with 15"–18" gooseneck microphones at the following locations.
 - Judge’s bench (one), clerk’s workstation (zero to two, at the discretion of the court), and attorney tables (two on each table) on movable bases with a mute button and a mute light. At the attorney’s tables, cabling shall be through separate grommets, not through the cable box used for power, video, and data.
 - Court reporter (zero to one, at the discretion of the court) and bailiff (zero to one, at the discretion of the court).
 - Witness station on a fixed threaded mount.
- b. If a floor box is provided for a lectern or DEPS cart, provide a microphone on a fixed threaded mount. If the lectern does not have a dedicated location, provide a clip for a handheld microphone
- c. Install a videoconferencing system based on the design criteria of section 18.D.6.
- d. At the discretion of the court, provide a boundary microphone at the judge’s location for use during a sidebar to record the sidebar and/or feed the court reporter’s headphone jack.
- e. Provide a minimum of two handheld wireless microphone for use by the jury and for general use by litigants and during voir dire. Provide a 4-channel wireless microphone receiver so that additional microphones can be used from other courtrooms if needed. The antennas can be either remotely located in the courtroom or mounted on a receiver within the courtroom.
- f. Provide a source of pink noise, enabled in all zones except the bench when the judge calls a sidebar. The court shall be able to set the volume as needed from the touch panel.
- g. Provide ceiling loudspeakers configured as a mix-minus system. In a mix-minus system, audio from microphones in a zone is not reproduced through loudspeakers within that zone. The ceiling loudspeakers shall be zoned as follows:
 - Jury (if the individual courtroom has a jury box)
 - Gallery

DIVISION TWO: TECHNICAL CRITERIA

- 11 Architectural Criteria
- 12 Structural Criteria
- 13 Mechanical Criteria
- 14 Building Management System Criteria
- 15 Electrical Criteria
- 16 Lighting Criteria
- 17 Network and Communication Systems
- 18 AUDIOVISUAL SYSTEMS**
- 18.A Audiovisual Design
- 18.B Audiovisual Criteria
- 18.C Technical Infrastructure
- 18.D Audiovisual Systems Descriptions
- 18.E Description of Courthouse Spaces
- 19 Acoustical Criteria
- 20 Fire Protection Criteria

- Bench
 - Well
- h. At the discretion of the court, provide loudspeakers in the holding cells with on-off control from the touch panel. If holding cells are shared between adjourning courtrooms, provide a system to select and route audio from either courtroom.
 - i. Provide an 8- to 12-channel audio feed for digital recording court proceedings. The actual recording equipment shall be provided by the court. At the discretion of the court, the feeds shall terminate at the equipment rack or be brought to the clerk's station within the courtroom. Provide audio input to allow recordings to be played back within the courtroom. At the discretion of the court, the channels shall be assigned to the following:
 - Judge and clerk (with optional sidebar)
 - Witness
 - Plaintiff/prosecution, wireless microphone, telephone receive, videoconference receive
 - Defense, lectern
 - Videoconferencing
 - j. Provide line-level monitor outputs for the clerk and court reporter.
 - k. Provide a two-channel ADA/CBC (Americans with Disabilities Act / California Building Code) compliant infrared assistive listening system used to meet ADA/CBC requirements (channel 1) and language translation (channel 2). At the discretion of the court, more than two channels may be specified if the court has a need for multiple languages translated simultaneously.
 - l. Provide a single-line teleconference system for making telephone calls using microphones (wired and wireless) and ceiling loudspeakers, with acoustic echo canceling on every microphone input. The output shall be selectable either to feed the ceiling speakers (default) or channel 2 of the assistive listening system for use when the language translator is remote. Depending on the courthouse system, the telephone system may be either analog or Voice over Internet Protocol (VoIP).
 - m. Provide a display for attorneys to display evidence and for judges to display jury instructions. All displays shall be placed so that the bottom of the image is a minimum of 48" above the finished floor. They may be either video projectors (~6,000–8,000 lumens) or flat panel displays (98" or larger). Display equipment shall have a minimum resolution of either 1,920 x 1,080 or 1,920 x 1,200 pixels. The projector shall be on a fixed mount on the courtroom ceiling with a lens selected to fill the projection screen. The screen shall be located opposite the jury. Provide appropriate power and data behind the screen for future installation of a flat panel display.
 - n. If a projector is used, provide an electrically operated projection screen with a contact closure interface, concealed in the ceiling when not in use, sized so that the height is one-sixth the distance to the back row of the jury. Match the aspect ratio to the projector.
 - o. Provide a multiformat routing switcher or network switch for source selection. In either case, the clerk or judge shall control access to the display.
 - p. Provide an additional display for the judge and/or clerk, if sightlines prevent the judge and/or clerk from seeing the display directly. It can be connected to a dedicated monitor

or a spare HDMI (High-Definition Multimedia Interface) or DVI (Digital Visual Interface) (not DisplayPort) input on a computer monitor supplied by the court.

- q. Provide access to the display from a computer on each counsel table and at the judge and clerk location. At the discretion of the court, provide access at the DEPS location.
- r. Provide a table box at each attorney's table to accommodate the computer inputs, along with power and data. Cutouts in the millwork shall be coordinated with the furniture provider.
- s. Provide only infrastructure to support a real-time transcription system between the court reporter and the judge, compatible with the systems used by the court.
- t. Provide document cameras for deployment in each courtroom. They may be mounted on carts, for mobility.
- u. Provide an AV control system with one 7" desk-mounted wired touch panel (Power over Ethernet (PoE)) that can be connected via a network cable at either the judge, clerk, or (optionally) bailiff location.
- v. Provide a button panel with a minimum of two buttons, permanently mounted at the judge's bench, to control, at a minimum, the sidebar function and audio/video mute.
- w. Provide infrastructure for two gallery monitors, consisting of power and data connections plus empty conduits for future signal connections. If not used on day one, wall boxes shall be behind the wall coverings, if possible.

3. High-Profile Courtroom

- a. Provide all the capabilities of the typical courtroom.
- b. Provide two flat panel gallery monitors on articulated mounts.
- c. Provide the capability for the judge to face forward during a videoconference rather than looking sideways at the projection screen, allowing the camera at the rear of the courtroom to pick up a full-face view of the judge, rather than a profile. It can be connected to a dedicated monitor or a spare HDMI or DVI (not DisplayPort) input on a computer monitor supplied by the court.
- d. Provide an installed videoconference system based on the design criteria of section 18.D.6.
- e. At the discretion of the court, provide audio and video feeds from the cameras or multimedia sources, plus a mix of the audio from within the courtroom to an alternative location within the courthouse for overflow capabilities. This signal shall use the Internet Protocol network for data transport. This feed must be separately enabled both in the courtroom and at the alternative location for security reasons.
- f. Provide a wall plate in the gallery on the same wall as is the jury for TV or radio stations feeding balanced analog audio (x 2) and 3G-SDI (serial digital interface) video (x 2) to a weatherproof media pedestal external to the building. Also include a balanced analog feed from the courtroom audio system and one 20-amp power circuit.

4. Courtrooms With Arraignment Dock

- a. Provide all capabilities of a typical or high-profile courtroom but without any accommodation for a jury.
- b. If the dock has floor-to-ceiling windows, provide a wall-mounted (not ceiling-mounted) tamper-resistant microphone, adjacent to or attached to the window overlooking the

DIVISION TWO: TECHNICAL CRITERIA

- 11 Architectural Criteria
- 12 Structural Criteria
- 13 Mechanical Criteria
- 14 Building Management System Criteria
- 15 Electrical Criteria
- 16 Lighting Criteria
- 17 Network and Communication Systems

18 AUDIOVISUAL SYSTEMS

- 18.A Audiovisual Design
- 18.B Audiovisual Criteria
- 18.C Technical Infrastructure
- 18.D Audiovisual Systems Descriptions
- 18.E Description of Courthouse Spaces

- 19 Acoustical Criteria
- 20 Fire Protection Criteria

courtroom. If the dock does not have a full glass wall, no microphone may be needed, unless the voices of those in custody need to be recorded.

- c. Provide ceiling loudspeakers with appropriate security hardware within the dock area.
- d. Provide touch panel controls of the speakers and microphones in the dock area.
- e. Discuss with the court in detail the exact expected use of the dock, and provide equipment to meet the needs.

5. Jury Deliberation Rooms

On a per-project basis, the court may choose to use these spaces as conference or meeting rooms, and if they do, the minimum infrastructure requirements for these types of spaces shall also be included.

- a. Provide a 75" flat panel for displaying evidence.
- b. Provide a floor box under the table for laptop inputs and a line-level output for the assistive listening system. This input will be used for connecting a laptop for displaying evidence saved electronically or for connecting a portable document camera.
- c. Provide a table box to accommodate the computer input, along with power, data, and audio output to feed the assistive listening system. Cutouts in the millwork shall be provided by the furniture providers.
- d. Provide a wall-mounted button panel for control of the AV system located at the video display.
- e. Provide a portable ADA-compliant encrypted RF assistive listening system with a microphone for voice pickup and input for multimedia audio at the table surface.

6. Jury Assembly Rooms

The jury assembly area consists of a single public space or multiple spaces that can be combined or separated to accommodate various functions and group sizes. The audiovisual systems in these spaces shall provide for speech reinforcement, paging, and the presentation of audiovisual materials to a group or groups of potential jurors. The public address system for emergency communication throughout the courthouse shall also serve the jury assembly areas. These areas may also be used by the court as multipurpose spaces for meetings, training, or multimedia presentations or for public events.

- a. Provide a sound system with overhead loudspeakers for voice amplification, television viewing, multimedia presentations, and juror orientation.
- b. Provide a 1080p resolution video projector (~5,000–8,000 lumens) on a fixed mount with a lens selected to fill the projection and/or television screens.
- c. Provide an electrically operated projection screen, concealed in the ceiling when not in use, sized as large as possible, taking into consideration ceiling height and the requirement that the bottom of the image shall be 48" above the floor. Match the aspect ratio to the projector.
- d. Provide a wireless handheld or clip-on microphone for ad hoc presentations.
- e. Provide a wired push-to-talk microphone for announcements.
- f. Provide a Blu-ray player for juror orientation.
- g. Provide a television tuner to entertain prospective jurors while they wait to be called.

Depending on the data source of TV and desires of the individual court, this tuner may be owner furnished.

- h. Provide an audio-only miniplug input for a background music source.
- i. Provide a single-channel ADA-compliant assistive listening system used to meet ADA requirements.
- j. Provide a computer input at the staff counter.
- k. Provide a multiformat routing switcher or network switch for source selection.
- l. At the discretion of the court, provide an input for the audio and video feed from the high-profile courtroom. This feed must be enabled separately in both the courtroom and the jury assembly room.
- m. At the discretion of the court, provide a floor box for a lectern with laptop inputs along with a wired microphone input.
- n. Provide an AV control system with one 7" wired touch panel (PoE) that can be connected via a network cable at the staff counter to control all aspects of the audiovisual system.
- o. At the discretion of the court, install a videoconferencing system.

7. Training Room

- a. Provide a sound reinforcement system with overhead loudspeakers for voice amplification and multimedia presentations.
- b. Provide one or more large flat panel displays, appropriately sized for the room.
- c. Provide a single-channel ADA/CBC-compliant RF or infrared assistive listening system for use to meet these requirements.
- d. Provide a floor box for a lectern or desk with laptop input.
- e. At the discretion of the court, provide a wireless handheld or clip-on microphone system.
- f. Provide a multiformat routing switcher or network switch for source selection. If feasible, combine this device with the audiovisual control system.
- g. Provide one 7" wall-mounted wired touch panel (PoE) to control all aspects of the audiovisual system.
- h. At the discretion of the court, install a videoconferencing system.

8. Judicial Conference Room

- a. Provide one or more large flat panel wall-mounted displays appropriately sized to the room, with separate side-mounted loudspeakers.
- b. Provide a portable or fixed ADA/CBC-compliant encrypted RF assistive listening system with a microphone for voice pickup and input for multimedia audio at the desk surface.
- c. Provide a floor box under the table with laptop inputs and a line-level output for the assistive listening system.
- d. Provide a table box to accommodate the computer input, along with power, data, and audio output to feed the assistive listening system. Cutouts in the millwork shall be provided by the furniture provider.

DIVISION TWO: TECHNICAL CRITERIA

- 11 Architectural Criteria
- 12 Structural Criteria
- 13 Mechanical Criteria
- 14 Building Management System Criteria
- 15 Electrical Criteria
- 16 Lighting Criteria
- 17 Network and Communication Systems

18 AUDIOVISUAL SYSTEMS

- 18.A Audiovisual Design
- 18.B Audiovisual Criteria
- 18.C Technical Infrastructure
- 18.D Audiovisual Systems Descriptions
- 18.E Description of Courthouse Spaces

- 19 Acoustical Criteria
- 20 Fire Protection Criteria

- e. Provide recording capabilities through the in-room AV system.
- f. Provide one 7" desk-mounted wired touch panel (PoE) to control all aspects of the audiovisual system.
- g. Provide a videoconferencing system with acoustic echo canceling on every input using microphones installed in the table and ceiling loudspeakers. Depending on court usage, provide a system that operates with multiple platforms, such as Zoom, Teams, and BlueJeans.

9. Executive Conference Room

- a. Provide a sound reinforcement system with overhead loudspeakers for voice amplification (depending on the size of the room) and multimedia presentations.
- b. Provide one or more large flat panel wall-mounted displays with separate side-mounted loudspeakers, soundbar, or integrated ceiling speakers.
- c. Provide a portable or fixed ADA/CBC-compliant encrypted RF assistive listening system with a microphone for voice pickup and input for multimedia audio at the desk surface.
- d. Provide a table box to accommodate input from a laptop, along with power and data. Cutouts in the millwork shall be provided by furniture providers.
- e. Provide a multiformat routing switcher or network switch for source selection and image processing. If feasible, combine this device with the audiovisual control system.
- f. Provide one 7" desk-mounted wired touch panel (PoE) to control all aspects of the audiovisual system.
- g. Install a videoconferencing system with one or more cameras integrated into the room AV system.

DRAFT

DIVISION TWO: TECHNICAL CRITERIA

19

ACOUSTICAL CRITERIA

SECTION	TOPIC	PAGE
19.A	Objectives	19.2
19.B	Acoustical Criteria	19.2
19.C	Best Practices	19.8

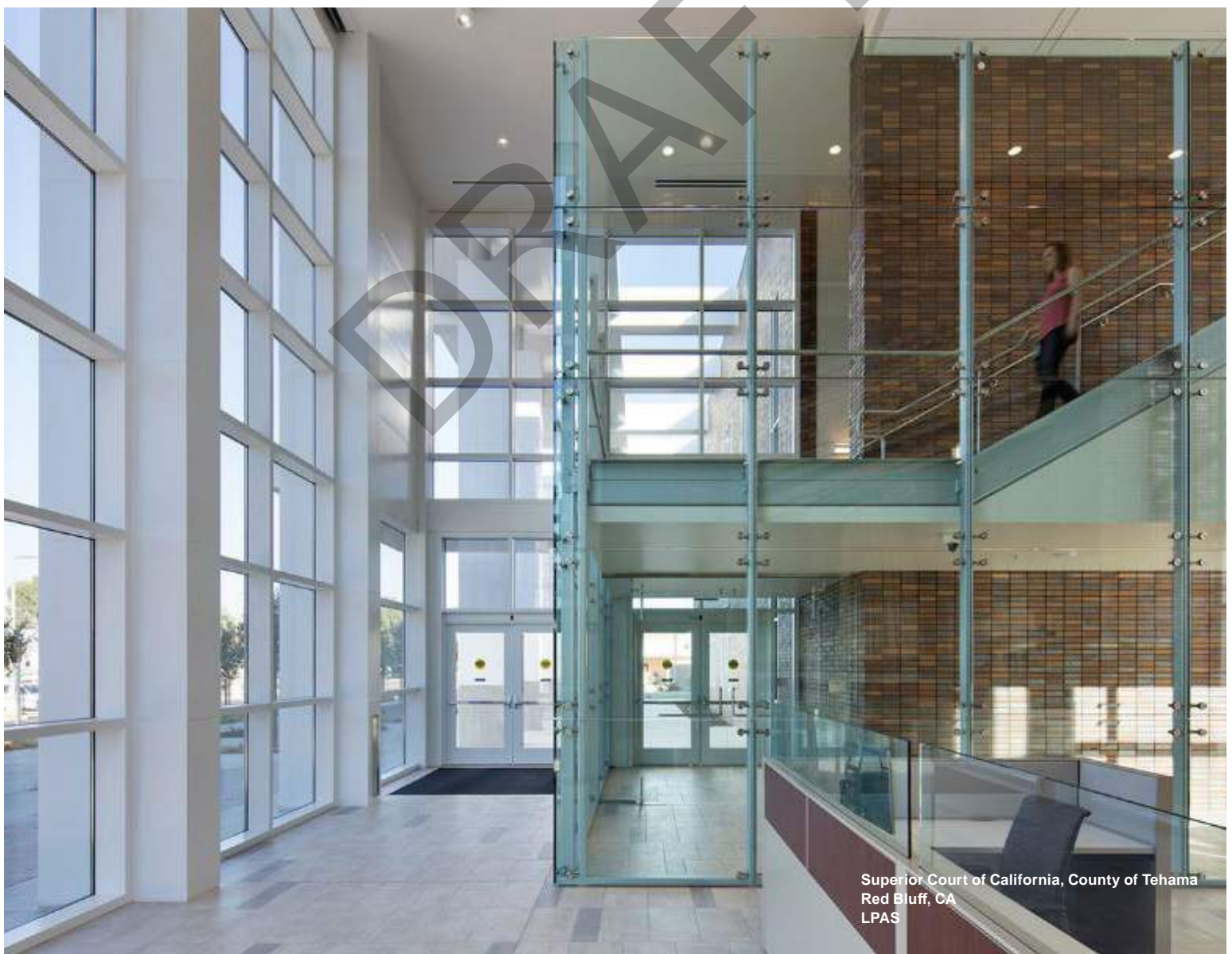

Factors to be considered in the acoustical design of the court facility include background noise levels, sound isolation, and room finishes. Courtrooms shall be quiet, be free of detectable echoes, and naturally enhance voice levels with strategic placement of sound-reflecting surfaces.

19.A OBJECTIVES

The goal of this chapter is to address acoustical criteria and best practices for room acoustics (reverberation and echo control), environmental noise reduction, sound isolation, speech privacy, and noise and vibration control of mechanical, electrical, plumbing, and vertical transportation equipment and systems. Each courtroom, except for very large courtrooms, shall be designed for effective spoken communication with minimum sound reinforcement. In the standard-sized trial courtroom, all participants should be able to hear and be understood at normal speech volumes.

19.B ACOUSTICAL CRITERIA

1. Background Noise Levels

The acoustic design goal for heating, ventilation, and air-conditioning (HVAC) systems is the achievement of a level of background noise that is unobtrusive and low enough that it does not interfere with the function of the space being served. Background noise should exhibit no tonal characteristics or noticeable time-varying levels resulting from aerodynamic instability or turbulence. To achieve these goals, the Noise Criteria (NC) family of curves is used as a design tool. These curves define the recommended octave band limits of an acceptable background noise spectrum for a particular space use.

The “Noise and Vibration Control” chapter of the American Society of Heating, Refrigerating and Air-Conditioning Engineers’ *ASHRAE Handbook—HVAC Applications* lists acceptable NC ratings for various spaces. Refer to table 19.1 for the recommended HVAC NC ratings for select spaces within the court facility. Using Room Criteria and reverberation time for setting design goals is the preferred method for courtrooms, conference rooms, and other high-occupancy spaces. Office areas and other lower-occupancy spaces may be designed by specifying the noise reduction coefficient (NRC) rating of finishes.

2. Room Acoustics

Room acoustics, including reverberation and echo control, defines the quality of sound within a space. Room acoustics is affected by room size, shape, proportions, geometry, and finishes. The standard metric for determining how “live” or “dead” a room acts is reverberation time (RT60). Hard surfaces—such as untreated gypsum board, concrete, glass, and wood paneling—will promote sound reflections and reverberation in a space. Soft-surfaced materials—such as acoustical tile, carpet, and fabric-wrapped fiberglass panels—will result in less reverberation.

Reverberation is the effect of sound reflecting and steadily decaying in a room. Conversely, echoes are distinct, late-arriving reflections from discrete wall surfaces. Absorptive materials, as well as proper room shaping or the addition of

Table 19.1 Background Noise Criteria

NOISE CRITERIA	SPACE TYPE—ROOM(S)
NC 30	Courtrooms
	Conference Rooms
	Meeting Rooms
	Training Spaces
	Interview Rooms
NC 35	Judicial Chambers
	Enclosed Offices
	Jury Deliberation Rooms
	Clerk’s Office
	Lactation Rooms
NC 40	Reception Areas
	Lobbies
	Open Office Areas
	Corridors
	Dining Areas
NC 50	Warehouses
	Parking Garages

diffusive panels, also help control any unwanted echoes.

Flutter echo is a resonant echo that occurs when sound reflects back and forth between two parallel, reflective surfaces.

Refer to table 19.2 for room acoustics considerations for select court facility spaces.

3. Sound Isolation and Speech Privacy

Table 19.2 Room Acoustics Requirements

SPACE TYPE	ROOM ACOUSTICS CONSIDERATIONS
Courtrooms	Reverberation time criteria should be between 0.6 and 1.0 seconds.
	The majority of the ceiling surface should be sound absorptive to help meet the reverberation time criteria.
	The wall behind the judge's bench, witness station, and clerk's workstation should be hard surfaced to provide good projection of voice to the jury.
	The walls and ceiling at the rear of the courtroom (around the spectator seating area) should be finished with an efficient sound-absorptive material to prevent sound from reflecting back to the well and the bench. This treatment is especially important for the back wall, to alleviate the reflection of sound between the judge's bench and the far end of the courtroom.
	A hard-surfaced ceiling over the judge's bench, slightly inclined outward, will have the effect of projecting a voice into the room without creating a flutter echo with the bench counter.
	The courtroom shall not be a long or narrow rectangle finished totally with sound-reflective materials. Such conditions can cause excessive flutter echo. Reducing the room length and using appropriately selected absorptive finishes can alleviate potential issues.
Conference Rooms, Training Spaces	Reverberation time criteria should be between 0.6 and 1.0 seconds.
	The majority of the ceiling surface should be sound absorptive to help meet the reverberation time criteria.
	A minimum of two perpendicular walls should feature sound-absorptive material to reduce overall reverberation and flutter echo.
	Carpet and upholstered furniture should be considered for conference and training rooms.
Enclosed Offices, Judicial Chambers, Jury Deliberation Rooms, Clerk's Office	The ceilings of these spaces should be a sound-absorptive material with a minimum noise reduction coefficient of 0.70.
Interview Rooms	The ceilings of the attorney side of interview rooms should be a sound-absorptive material with a minimum NRC of 0.70, and floors should be carpeted. The ceilings of the in-custody side of interview rooms should be detention-grade perforated metal and backed with a 1" thick sound-absorbing material with a minimum NRC of 0.70.
Open Office Areas	The ceilings of open office spaces should be a sound-absorptive material with a minimum NRC of 0.85.
	Reverberation time criterion should be less than 1.5 seconds.
Lobbies	If lobbies will function as more than just circulation and security checkpoints (for receptions, speeches, gatherings, etc.), the reverberation time criterion should be reduced to approximately 1.0 second.
	A sound-absorptive ceiling is recommended in the lobby to help control excessive reverberation and loudness.
	Additional absorptive wall material will be required to meet the 1.0 second reverberation time criterion.

DIVISION TWO: TECHNICAL CRITERIA

- 11 Architectural Criteria
- 12 Structural Criteria
- 13 Mechanical Criteria
- 14 Building Management System Criteria
- 15 Electrical Criteria
- 16 Lighting Criteria
- 17 Network and Communication Systems
- 18 Audiovisual Systems
- 19 ACOUSTICAL CRITERIA**
- 19.A Objectives
- 19.B Acoustical Criteria
- 19.C Best Practices
- 20 Fire Protection Criteria

NIC: A field-measured noise reduction from a building design element

STC: Sound isolation performance as measured in a controlled laboratory

STC and NIC are one-number rating systems that allow for an easy comparison of the acoustical performance between different constructions. The higher the STC or NIC rating of an assembly, the less sound is transmitted through it.

Sound isolation is the capacity of a structure to prevent sound from being transmitted from one space to another. Sound isolation is quantified by two numerical ratings, noise isolation class (NIC) and sound transmission class (STC).

Refer to table 19.3 for sound-isolating performance requirements for court facility spaces. Where more than one STC rating can be applied to a specific adjacency, the higher STC rating shall be used for the assembly. Refer to the acoustic guidelines established by the Office of Noise Control in the California Department of Health Services and other similar requirements for rated assembly types.

Speech privacy within a space depends on the sound insulation performance of its partitions and doors, the background sound level, the loudness of speech, and the room finish treatment. *Confidential speech privacy* is speech that is detectable but with individual words that are indiscernible.

To achieve a normal speech privacy level, the sum of both numbers shall equal 70 or more. *Normal speech privacy* is when a few words may be understandable, but complete sentences cannot be comprehended.

For normal to raised speech levels, confidential speech privacy should be achieved when the STC rating of the construction separating two spaces plus the background NC level is greater than 80. A raised voice might result during lively conversation or the use of a speakerphone. For example, if the room adjoining the space under consideration has a background noise level of NC 30, the intervening partition must have an STC rating of 50 to achieve confidential speech privacy. Unless a reliable source of background noise, such as a sound-masking system, is provided in the adjoining space, an STC 50 construction assembly is generally required to achieve greater levels of speech privacy.

A higher STC rating or higher background noise levels would be required to achieve confidential privacy for raised or loud voice levels. The limit of the speech range would be a loud voice, which occurs when the speaker is exerting maximum speech effort or when the speaker is amplified electronically.

Details and specifications shall be provided by the design firm to appropriately construct sound-rated partitions in the field. Seal the perimeter of sound-rated walls, penetrating elements, outlets, junction boxes, and low-voltage receptacles to maintain sound isolation.

4. Doors

Doors to noise-sensitive areas should have sufficient sound transmission loss performance so that the partition sound isolation is not unduly compromised. Doors in partitions of noise-sensitive rooms represent the acoustic weak link in the system. Refer to table 19.4 for door requirements for select spaces within the court facility. Sound isolation requirements for doors to mechanical rooms should be reviewed on a case-by-case basis.

5. Interview Room Windows

An unamplified passive solution for communication through the window to both sides of an interview room shall be provided; an amplification system shall be avoided. The glazed opening between the attorney and in-custody interview rooms must provide a sufficient free (open) area to support unamplified conversation between the two rooms. See tool 5, In-Custody Interview Room Guidelines.

6. Operable Partitions

Table 19.3 Sound-Isolation Requirements

STC OF PARTITION*	SPACE TYPE & ADJACENCY
STC 65	Courtroom to holding cell
	Electrical rooms containing transformers to NC 30 spaces†
	Elevator shafts to NC 30 spaces†
	Hydraulic elevator equipment room to NC 30 spaces†
	Mechanical rooms to NC 30 spaces†
STC 55	Large or special proceedings courtrooms to adjoining areas
	Jury deliberation room to adjoining areas
	Large conference rooms and training rooms to adjoining areas
	Judicial conference rooms to adjoining areas
	Toilet rooms to adjoining areas—with plumbing†
	Computer and server rooms containing fans and cooling equipment to adjoining areas†
STC 50	Courtrooms to adjoining areas
	Judicial chambers to adjoining areas
	Small conference rooms to adjoining areas
	Family law mediator office to adjoining areas
	Private offices requiring confidential speech privacy
	Toilet room to adjoining areas—no plumbing
	Telecommunications and audiovisual rooms with cooling equipment to adjoining areas
	Attorney interview rooms to adjoining areas (unless otherwise noted)
STC 45	Electrical rooms with no transformers to adjoining areas
	Workroom to adjoining areas
	Jury assembly area to adjoining areas
	Orientation room to adjoining areas
	Private offices requiring normal speech privacy
	Office equipment rooms to adjoining areas
	Waiting rooms to adjoining areas
	Lactation rooms—partition to enclosed space
	Telecommunications and AV rooms with minimal equipment to adjoining areas
Attorney interview room to public corridor or vestibule	
STC 40	General office space to general office space
	In-custody interview rooms to adjacent spaces
STC 35	Lactation rooms—partition to corridor

* Partitions with doors need only be 10 points greater than the STC rating of the door.

† The partitions between shared restrooms and between restrooms or mechanical equipment rooms and occupied areas, especially where the partition contains piping, should feature two independent stud rows with a nominal 1" air space in between. The studs should not be bridged by any bracing. The two separate stud rows should provide enough room to prevent the piping contained within from directly contacting any part of the partition. Where the restroom or mechanical equipment room is adjacent to occupied space, both stud cavities should be filled with batt insulation, and a minimum of two layers of 5/8" gypsum board should be installed on the occupied side of the partition.

**DIVISION TWO:
TECHNICAL CRITERIA**

- 11 Architectural Criteria
- 12 Structural Criteria
- 13 Mechanical Criteria
- 14 Building Management System Criteria
- 15 Electrical Criteria
- 16 Lighting Criteria
- 17 Network and Communication Systems
- 18 Audiovisual Systems
- 19 ACOUSTICAL CRITERIA**
- 19.A Objectives
- 19.B Acoustical Criteria
- 19.C Best Practices
- 20 Fire Protection Criteria

AHUs = air-handling units

ANSI = American National Standards Institute

dB or dBA = decibel

IIC = impact insulation class

NEMA = National Electrical Manufacturers Association

OITC = outdoor-indoor transmission class

VAV = variable air volume

Table 19.4 Door Requirements

SPACE TYPE	DOOR REQUIREMENTS
Courtroom to Courtroom	Interconnecting doors are not recommended; use vestibules, if possible. If not possible, use only a laboratory-rated STC 53 door (or two fully gasketed doors in tandem).
Courtroom to Jury Deliberation Room	
Jury Deliberation Room	Laboratory-rated STC 43 (an electronic sound-masking system) is recommended in the corridor outside all nonequipment rooms.
Judge's Chambers	
Judicial Conference Room	
Attorney Conference and Interview Room (to public corridor)	A minimum 1-3/4" solid-core wood door or hollow metal steel door with a full set of acoustical seals—including perimeter gasketing, an automatic door bottom, and a removable center post or overlapping astragal between double doors—is recommended.
Computer and Server Rooms Containing Fans and Cooling Equipment (to occupied areas)	
Conference Rooms and Training Rooms	
Telecommunications and AV Rooms	
Courtroom Public Vestibule (both door sets)	
Courtroom and Attorney Interview Room to Secure Vestibule/Hallway	
Court Reporters' Work Area	
Small Electrical Rooms (to occupied areas)	
Mediation Rooms	
Investigator's Office	
Private Offices Requiring Speech Privacy	
In-Custody Interview Rooms	
Lactation Rooms	

The recommendations below should be considered if operable partitions will be included within the court facility:

- a. The operable partition should be chosen with minimum ratings of STC 50 and NIC 42.
- b. If the operable partition is separating a conference room, training room, or jury assembly space, an operable partition with a sound-absorptive finish with a minimum rating of NRC 0.65 would be beneficial.
- c. Perimeter conditions must be properly detailed to reduce the effect of flanking and to maintain the transmission loss performance of the operable partition. Following are important conditions to consider:
 - Provide an overhead barrier above the ceiling. The gypsum board barrier should be constructed without gaps and sealed airtight.
 - Sidewall construction should be able to accept and withstand the pressure of the end partition panel. The sidewall finish must meet the end panel of the operable partition continuously. There should be no voids or reveals at baseboards, ceilings, and the like.
 - The deployed horizontal operable partition should span entirely across the storage room through the closet to the farthest sidewalls. The panels should not end at the storage room doors. The design should be carefully coordinated with the operable partition manufacturer.

7. Impact Insulation

Impact noise, or footfall noise, is created when an object strikes a floor/ceiling assembly or when a person walks across a floor. The noise from the impact is transmitted through the assembly and into the space below. The ability of floor and ceiling construction to insulate impact sounds can be determined by the IIC rating. As with the STC rating, the higher the IIC value of the assembly, the better the construction is at reducing impact noises.

- a. Typical floor/ceiling assemblies between occupied spaces within the court facility should achieve a minimum IIC rating of 50 to help reduce footfall noise between vertically adjacent areas.
- b. Rooms with carpet on a concrete slab should meet a minimum IIC 50 rating.
- c. Wood-framed construction presents special impact-insulation problems and should receive careful attention.
- d. Spaces with hard-surfaced flooring materials such as ceramic tile or wood most likely will not meet IIC 50. For all spaces with hard-surfaced floor materials, consider installing a resilient underlayment material within the floor/ceiling assembly to help meet the minimum IIC rating requirement.

8. Environmental Criteria

To identify noise levels in decibels (dB, or dBA) at a potential site under consideration, conduct an environmental noise study that tests for average and single-event noise. Perform this study for all potential project sites, especially near roadways, highways, trains, busy urban areas, and flight paths. The duration of the noise study should range from one to four days, depending on the conditions at the site. The primary hours of measurement should coincide with the typical hours of courtroom use.

Based on results of the environmental noise study, calculate minimum exterior façade

DIVISION TWO: TECHNICAL CRITERIA

- 11 Architectural Criteria
- 12 Structural Criteria
- 13 Mechanical Criteria
- 14 Building Management System Criteria
- 15 Electrical Criteria
- 16 Lighting Criteria
- 17 Network and Communication Systems
- 18 Audiovisual Systems
- 19 ACOUSTICAL CRITERIA**
- 19.A Objectives
- 19.B Acoustical Criteria
- 19.C Best Practices
- 20 Fire Protection Criteria

outdoor-indoor transmission class (OITC) and STC ratings required to achieve an interior maximum single-event noise level of 50 dBA. For intrusive noise from exterior sources, such as traffic, calculation of the interior maximum single-event noise level using L10 (the measured noise level that is exceeded 10 percent of the measurement period) is recommended. The L10 is known as the *intrusive noise level* and is the level that may be noticed when engaging in activities requiring lesser degrees of concentration.

19.C BEST PRACTICES

The following general recommendations address noise reduction from mechanical, electrical, plumbing, and vertical transportation systems and equipment; sound isolation and speech privacy; and room acoustics.

1. Mechanical, Electrical, Plumbing, and Vertical Transportation Systems and Equipment Noise Control

- a. Locating air-handling units (AHUs) and other noisy equipment above courtrooms or other noise-sensitive spaces may require expensive and complicated mitigation measures, such as sound-attenuating ceilings, thickened slabs, or floating floors.
- b. Do not use rooftop down-discharge AHUs, if possible. Instead, use side-discharge units, maximizing the length of ductwork between the unit and the roof penetration point. Noise mitigation of down-discharge units may be prohibitively complicated and expensive.
- c. Provisioning space for sound attenuators is advisable early in the HVAC system design. Typical attenuators would be 5' in length and should be planned for the intake and discharge side of each main air-moving system. Ductwork before and following each attenuator should be straight and at least two duct diameters in length.
- d. Do not locate variable air volume (VAV) units above courtrooms, chambers, conference rooms, or other rooms with a Noise Criteria level of NC 35 or less. Instead, locate VAV boxes in corridors or unoccupied spaces. If not possible, a gypsum board ceiling or an enclosure around the VAV box may be required.
- e. Locating fan-powered VAV boxes above spaces with a noise criterion of NC 45 or less may require expensive and complicated sound-attenuating ceilings.
- f. Do not exceed 1-1/4" of static pressure at VAV box inlets.
- g. Select air diffusers at least five points below the NC rating of the room they serve.
- h. Locate volume dampers at least 10' upstream from air diffusers in rooms with an NC rating of 35 or less. Do not use opposed-blade dampers in the face of outlet devices.
- i. Provide a minimum 3' of insulated-type flexible duct upstream of all supply diffusers and return grilles. The flexible duct should be free of kinks or deformities.
- j. Maximum duct velocities shall be designed to meet the requirements listed in the "Noise and Vibration Control" chapter of *ASHRAE Handbook—HVAC Applications*.
- k. Vibration-isolate all mechanical and plumbing equipment per the requirements listed in the "Noise and Vibration Control" chapter of *ASHRAE Handbook—HVAC Applications*.
- l. All mechanical water, domestic water, and steam piping shall be resiliently supported as described in the "Noise and Vibration Control" chapter of *ASHRAE Handbook—HVAC Applications*.
- m. Independent seismic restraints are preferred to vibration isolators with integral seismic

restraints.

- n. Ductwork attached to the fan discharge is to be connected with a flexible connection.
- o. Pipe and conduit penetrations through full-height partitions and floors shall be slightly oversized and sealed airtight with resilient sealant. A neoprene pad should be installed between all pipe clamps and the structure. There shall be no direct contact between the penetrating element and the structure.
- p. Non-fire-rated ducts penetrating full-height partitions shall have a clear distance of at least 1/2" around the perimeter. The perimeter void must be packed with glass-fiber batts at both ends and caulked airtight with a nonshrinking, nonhardening, flexible acoustical sealant and a backer rod, if required.
- q. All water pipes should be sized for a maximum velocity of 4 feet per second (fps) for pipe 2" and smaller and 10 fps for larger pipe sizes.
- r. To vibration-isolate transformers, inverters, rectifiers, and an uninterruptible power supply, use flexible conduit and resilient neoprene mounts with a minimum static deflection of 1/4".
- s. Avoid locating transformer rooms near sensitive locations. If not possible, consider double-stud partition construction.
- t. Penetrations of cable trays through full-height partitions shall be packed tightly with heavy-density putty once the cables are pulled.
- u. Emergency generators will often require acoustical provisions such as exhaust mufflers, spring vibration isolators, and low-pressure drop attenuators at the discharge and intake louvers. Locate the emergency generator within the building, away from any noise-sensitive areas, when possible.
- v. Provide transformers with sound levels that do not exceed the following maximums in accordance with National Electrical Manufacturers Association (NEMA) and American National Standards Institute (ANSI) standards. The manufacturer is to verify that the actual sound levels comply by conducting sound tests before shipping to the project site.
 - 25–50 kilovolt-amperes (kVA): 45 dB
 - 51–150 kVA: 50 dB
 - 151–300 kVA: 55 dB
 - 301–500 kVA: 60 dB
- w. Resilient piping attachments are recommended to isolate the plumbing piping and fixtures from the structure when the plumbing runs adjacent to occupied noise-sensitive areas. There shall be no direct contact of plumbing piping to studs or the back of drywall.
- x. Limit pressure at fixtures to 70 pounds per square inch or less to minimize noise generation.
- y. Pipes and conduits should not pass through sensitive spaces to service other areas.
- z. Toilet rooms should be located away from noise-sensitive spaces. Do not put plumbing in walls next to or common with these spaces.
- aa. Holding cell toilet fixtures should not be installed on partitions adjacent to occupied noise-sensitive spaces.
- bb. Specify quiet devices such as quiet-type flush valves and taps with full-ported nozzles

DIVISION TWO: TECHNICAL CRITERIA

- 11 Architectural Criteria
- 12 Structural Criteria
- 13 Mechanical Criteria
- 14 Building Management System Criteria
- 15 Electrical Criteria
- 16 Lighting Criteria
- 17 Network and Communication Systems
- 18 Audiovisual Systems
- 19 ACOUSTICAL CRITERIA**
- 19.A Objectives
- 19.B Acoustical Criteria
- 19.C Best Practices
- 20 Fire Protection Criteria

and nonsplash aerators. If toilet rooms are unavoidably next to sensitive spaces, use siphon-jet, tank-type water closets with adjustable-flow valves.

- cc. Install air chambers or shock-absorbing devices to prevent water hammer in lines subject to abrupt shutoff.
- dd. All vertical transportation systems—such as hydraulic elevators, traction elevators, or escalators—should incorporate the most effective vibration isolation system available from the elevator manufacturer to limit the amount of structure-borne noise introduced into the building. Elements to consider include, but are not limited to, pumps, motors, hydraulic lines, equipment rooms, hoists, sheaves, control units, roller wheels, and guide rails.

2. Sound Isolation and Speech Privacy

- a. Mass and airspace are effective means to increase the sound isolation performance of partitions. Flanking paths, such as above-ceiling ducts or window mullions at partitions, degrade sound isolation performance.
- b. The recommendation is to use the lightest-gauge studs possible. The stud depth and stud spacing of the partition should also be considered. The greater the stud depth and stud spacing, the better the partition should perform acoustically.
- c. Higher levels of sound isolation are required for incompatible adjacencies or when acoustically sensitive spaces are located near sound-generating equipment.
- d. Sound-rated partitions shall be sealed with nonhardening acoustical sealant around the entire perimeter and at partition intersections.
- e. Full-height partitions should be used between adjacent rooms where confidential speech privacy or high levels of sound isolation are required.
- f. For partitions requiring normal speech privacy, use a foam seal tape between the top of partition and the lay-in ceiling, or extend the partition 6" above the ceiling.
- g. Consider providing a sound-masking system, where the partition construction does not allow adequate speech privacy and/or where the background noise level is expected to be lower than desired.
- h. For adjacent spaces along the exterior window façade where speech privacy is required, the joint detail between the partition and the mullion will need to be carefully reviewed and coordinated. It may be necessary to treat the window mullion with a layer of wood or gypsum board on each side of the partition where the partition intersects the exterior window.
- i. Doors with cam-lift hinges and thresholds are preferable to standard hinges. Use a threshold with integral gasketing. Doors with drop-bottom gasketing will require periodic maintenance to align seals. Do not use noisy panic hardware.
- j. Use heavy-duty adjustable or dual gaskets, such as compression sound gaskets and smoke gaskets, in tandem, for sound-isolating doors.
- k. Use acoustically rated doors where an exceptional degree of sound isolation is required.
- l. Avoid duct paths that will create crosstalk between spaces.
- m. The return-air path for rooms requiring confidential speech privacy should use a fully ducted return system. If not possible, install acoustically lined sound boots with at least one 90-degree turn on the return grilles. Aim the air opening away from the corridor.

- n. Recessed junction boxes of all types must be offset at least 16" on opposing sides of sound-rated construction.
- o. Recessed junction boxes 4-gang and smaller are to have the back and sides sealed airtight using sheet caulking. Junction boxes larger than 4-gang require gypsum board backing.
- p. Conduit must not bridge independently framed sound-rated partitions or resilient ceilings by rigidly connecting to the framing. Flexible conduit connections are required.
- q. Use plastic tape, fiberglass, or neoprene wrapping to avoid all metal-to-metal contact.

3. Room Acoustics

Excessive reverberation can adversely affect speech intelligibility. However, a room with too much sound absorption on its wall surfaces can be perceived as acoustically dead. To achieve the proper balance of sound-reflecting versus sound-absorbing surfaces, alternating "hard" and "soft" surfaces can be installed on the sidewalls. The panels should be arranged such that a hard-surfaced panel directly faces a soft panel on the opposing wall.

- a. Typical fabric-wrapped sound-absorbing panels shall be at least 1" thick with a minimum NRC of 0.70 or 2" thick with a minimum NRC of 0.85 (preferred).
- b. Fabric for acoustical panels must be porous. Do not use fabric with acrylic or other impervious backings.
- c. Acoustically absorptive materials installed on walls and ceilings should be as uniformly distributed as possible to achieve the target reverberation time as well as good speech intelligibility throughout the space.
- d. Avoid concave or domed surfaces, which focus sound energy. If these surfaces cannot be avoided, they must be acoustically treated. Convex surfaces, which scatter sound energy, are preferred.
- e. An efficient (i.e., NRC of 0.80+) sound-absorbing ceiling is the most effective initial treatment to control reverberation and loudness in most occupied rooms.

DIVISION TWO: TECHNICAL CRITERIA

- 11 Architectural Criteria
- 12 Structural Criteria
- 13 Mechanical Criteria
- 14 Building Management System Criteria
- 15 Electrical Criteria
- 16 Lighting Criteria
- 17 Network and Communication Systems
- 18 Audiovisual Systems
- 19 ACOUSTICAL CRITERIA
 - 19.A Objectives
 - 19.B Acoustical Criteria
 - 19.C Best Practices
- 20 Fire Protection Criteria

DRAFT

DIVISION TWO: TECHNICAL CRITERIA

20

FIRE PROTECTION CRITERIA

SECTION	TOPIC	PAGE
20.A	Objectives	20.2
20.B	Fire Protection Criteria	20.2
20.C	Fire Alarm System Objectives	20.8
20.D	Fire Alarm System Criteria	20.9

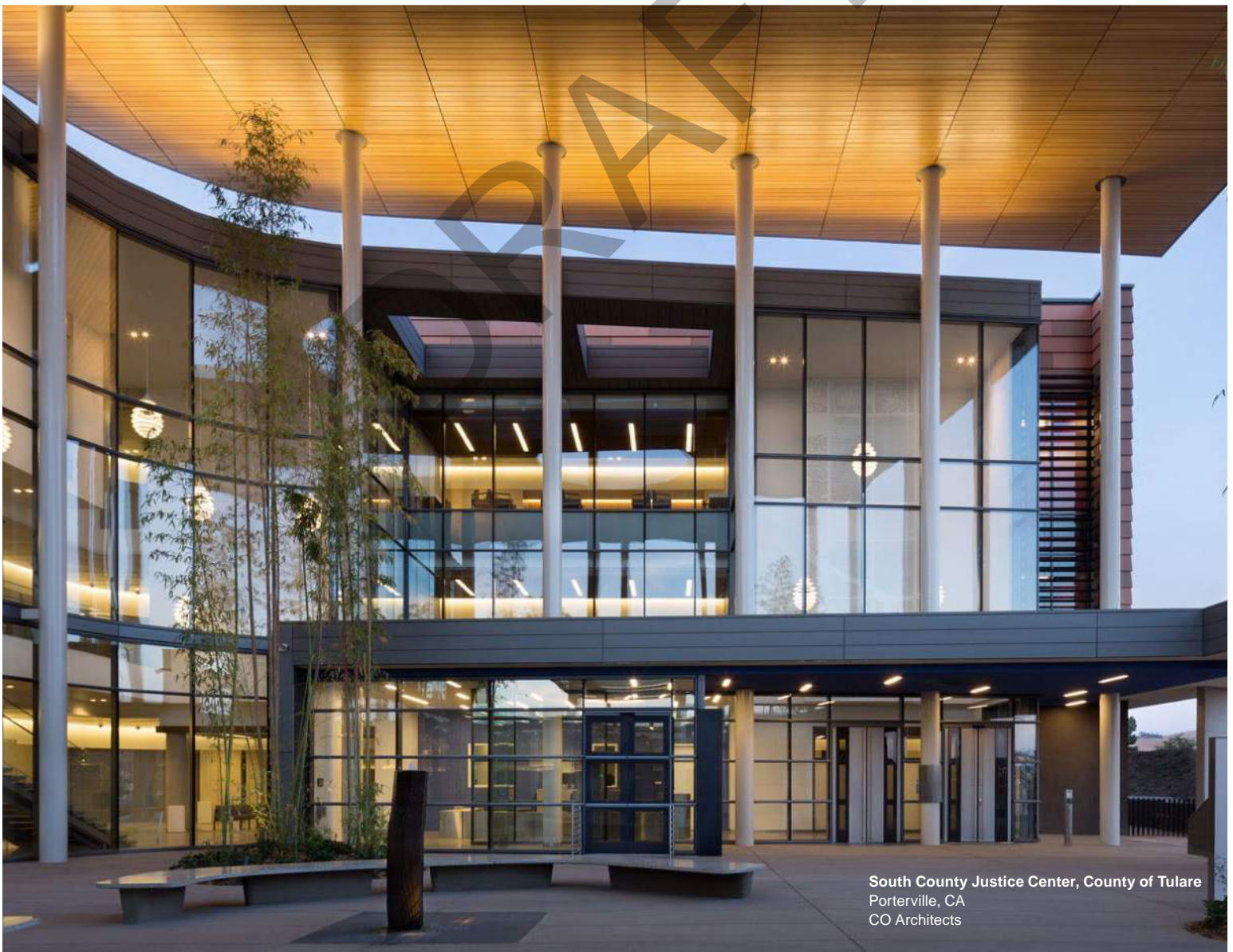

South County Justice Center, County of Tulare
Porterville, CA
CO Architects

This chapter defines the general and technical criteria for fire protection systems, including recommendations and minimum acceptable performance criteria.

AHJ = authority having jurisdiction

AWWA = American Water Works Association

DPDT = double pole, double throw switch

NFPA = National Fire Protection Association

20.A OBJECTIVES

Fire protection systems protect life and property from fire through standardization of design, installation, and testing requirements for sprinkler systems based on sound engineering principles, applicable state fire code, and field experience. The following criteria set minimum acceptable standards for design and installation of fire protection systems. New technology and alternative arrangements may be applied in accordance with section 104.11 of the California Building Code (CBC) on written Judicial Council approval, but they shall not reduce safety levels prescribed by these criteria or by state fire and building codes.

Designers shall use the following criteria to develop fire protection systems for new buildings, automatic sprinkler system retrofits of existing unsprinklered buildings, or interior renovation of existing buildings. When the criteria are applied to interior renovations of existing structures, designers shall provide systems that meet design parameters of either the existing fire protection system or the criteria that satisfy applicable codes.

20.B FIRE PROTECTION CRITERIA

1. Interior Finishes

Wood required to be fire retardant shall, during the manufacture process, be treated with fire-retardant chemicals by a pressure impregnation process that treats the materials throughout (as opposed to on the surface only).

All interior finish materials shall have flame spread index and smoke-developed index as outlined in California Code of Regulations, title 24, based on the occupancy classification of various spaces in the courthouse.

2. Automatic Sprinkler Systems

- a. All fire suppression systems shall be designed by a California registered fire protection engineer. Deferred-approval construction shop drawings may be prepared by a Class C-16 fire protection contractor (Cal. Code Regs., tit. 16, § 832.16).
- b. For areas subject to freezing, automatic sprinkler systems shall be dry-pipe sprinkler systems.
- c. Active fire protection, including an automatic sprinkler system, shall be required during construction, alteration, and demolition operations in accordance with the California Building Code and California Fire Code.
- d. Automatic sprinkler system zones shall be established by the installation of accessible floor control assemblies for all floors in multistory buildings, including basements.
- e. Automatic sprinkler system designs (wet pipe) shall achieve the minimum design criteria listed in table 20.1.
- f. The maximum working pressure for sprinkler systems shall be limited to 175 pounds per square inch (psi).
- g. For automatic sprinkler systems in mechanical rooms, install the sprinkler system per NFPA requirements using corrosion-resistant, standard-response sprinklers.
- h. Provide high-temperature-grade sprinkler heads in the generator room, the boiler room, and other high-temperature areas.
- i. Coordinate the location of each sprinkler head with the various systems shown in the reflected ceiling plan, including lighting, diffuser, and grille layout. Sprinklers shall be

Table 20.1 Minimum Design Criteria for Automatic Sprinkler System Designs (Wet Pipe)

OCCUPANCY CLASSIFICATION	DESIGN DENSITY (GPM/FT ²)	DESIGN AREA (FT ²)	HOSE STREAM ALLOWANCE (GPM)*	DURATION OF SUPPLY (MINUTES)
Light Hazard	0.10	1,500	100	30
Ordinary Hazard Group 1	0.15	1,500	250	60
Ordinary Hazard Group 2	0.20	1,500	250	60
Extra Hazard Group 1	0.30	2,500	500	90
Extra Hazard Group 2	0.40	2,500	500	90

* Combined inside/outside.
gpm/ft² = gallons per minute per square foot.

installed in center-of-tile locations for suspended ceilings, based on the dimension of the ceiling tiles.

- j. Specify sprinkler head guards to be installed on any heads subject to possible mechanical injury. Sprinkler head guards shall be Underwriters Laboratories (UL) listed for the specific sprinkler the guard is protecting.
- k. Provide sprinkler guards on sprinklers installed in the following locations:
 - Within elevator machine rooms and elevator pits.
 - Within electrical closets.
 - Within electrical equipment rooms.
 - Less than 7'6" above the floor.
 - In main distribution frame (MDF) rooms, unless concealed-type sprinklers are installed.
- l. On retrofit projects, replace existing standard-response sprinklers in light-hazard areas with quick-response sprinklers throughout the areas being retrofitted.
- m. Provide a framed, printed sheet (protected by transparent plastic, safety glass, or a plexiglass cover) with brief instructions regarding all necessary aspects of sprinkler controls and emergency procedure next to sprinkler main risers.
- n. Install the main drain at riser and auxiliary drains at all low points in the system on each floor. Install inspector's test drains on the sprinkler system at the main riser assembly. Five or fewer trapped heads may be drained through a plugged fitting. Route the drainpipes for each sprinkler riser, and test connections to the building sanitary sewer system. The sewer system shall be designed to accommodate full flow for the main drain.
- o. Coordinate sprinkler drain locations with plumbing drawings.
- p. Coordinate the location of and access to fire pump rooms and the location of signage, keying, and fire sprinkler shutoff and zone valve access with local fire authorities. Access and signage shall be obvious. Visibility shall not be blocked by equipment.

3. Fire Water Tanks

- a. Onsite water storage, where required, shall be designed and installed per NFPA 22.
- b. Fire water tanks shall be installed as part of the building, at the exterior or in a separate

**DIVISION TWO:
TECHNICAL CRITERIA**

- 11 Architectural Criteria
- 12 Structural Criteria
- 13 Mechanical Criteria
- 14 Building Management System Criteria
- 15 Electrical Criteria
- 16 Lighting Criteria
- 17 Network and Communication Systems
- 18 Audiovisual Systems
- 19 Acoustical Criteria

20 FIRE PROTECTION CRITERIA

- 20.A Objectives
- 20.B Fire Protection Criteria
- 20.C Fire Alarm System Objectives
- 20.D Fire Alarm System Criteria

structure to prevent flooding of the main building interior in the event of a leak. Fire water tanks shall be protected from freezing.

- c. Fire water tanks shall be protected from exposure to fires as required in accordance with NFPA 22.
- d. An underground fire tank, if applicable, shall be installed outside the building foundation.
- e. Approval from the authority having jurisdiction shall be obtained for buried fire water tanks and installed in accordance with NFPA 22.
- f. Fire water tank materials shall be of steel or double-layer fiberglass. Fire water tanks shall not be constructed of concrete.
- g. Fiberglass-reinforced plastic tanks shall be permitted for storage of water at atmospheric pressure only. If located inside a building, they shall be protected by automatic fire sprinklers in accordance with NFPA 22.
- h. Provide adequate access to the fire water tank, valves, and pipe, and prevent confined space entry conditions. The service entry shall be from a top hatch. If the entry is from the side, it shall be large enough for feet-first rather than head-first entry and is subject to approval of the Judicial Council and the California Office of the State Fire Marshal (OSFM). Design shall allow for access in an emergency situation.
- i. Fire water tanks shall be periodically inspected, tested, and maintained in accordance with NFPA 25.

4. Hydrants

Design and installation shall comply with NFPA 24 and meet requirements of the California Office of the State Fire Marshal and the local fire department, except as follows.

- a. Contact the responding fire department for hydrant and water pressure requirements.
- b. Fire hydrants shall be located as required by section 507.5 and Appendix C of the California Fire Code (Cal. Code Regs., tit. 24, pt. 9). The approximate distance between a fire hydrant and the building fire department connection shall be 50'.
- c. Wet barrel hydrants are preferred where piping is not subject to freezing.
- d. Locate hydrants adjacent to paved areas, no closer than 3' and no farther than 7' from roadway shoulder or curb line, accessible to fire department apparatus. Barrels shall be long enough to permit at least 18" clearance between center of pumper connection and grade. Pumper connection shall be perpendicular to the street to allow straight-line connection to the pumper.
- e. Design site grading for surface drainage away from the hydrant.

5. Fire Pump Requirements

Evaluate fire pump requirements based on building size, number of floors, occupancy, and available city water pressure. Specify fire pump, jockey pump, and associated control system in accordance with NFPA 20 requirements.

- a. Specify that a single vendor shall furnish pumps, motors, transfer switches, and all controls. All equipment shall be UL listed.
- b. Fire pump buildings or rooms enclosing diesel engine pump drivers and days tanks shall be protected with an automatic sprinkler system in accordance with NFPA 13 as an Extra Hazard Group 2 occupancy.

- c. Fire pump buildings or rooms with electric fire pump drivers shall be protected with an automatic sprinkler system in accordance with NFPA 13 as an Ordinary Hazard Group 1 occupancy.
- d. Require the pump manufacturer or representative to provide the services of a qualified Fire Protection Engineer for startup and acceptance testing, in the presence of the authority having jurisdiction (AHJ).
- e. A fire pump must start automatically at 10 psi below pressure maintenance pump (jockey pump) start pressure. The fire pump must be manually shut down, except that operation by automatic periodic exercise timers used for the required maintenance run times is to be incorporated. The fire pump installation must include a test header and a flow meter.
- f. Where an emergency generator is required or provided, and the emergency generator is intended to provide secondary or backup power to the fire pump, coordinate the electric fire pump starter type and loads with the generator for adequate starting capacity.
- g. Fire pump rooms shall be provided with emergency lighting.

6. Piping Requirements

- a. All above-ground automatic sprinkler system piping shall comply with the provisions of NFPA 13. Only black steel piping shall be allowed for above-ground piping.
- b. For above-ground piping, provide a single air vent at a high point in the system in accordance with NFPA 13.
- c. All underground fire protection piping shall comply with NFPA 24.
- d. For corrosive soil areas, the underground piping shall be encased in polyethylene encasement in accordance with AWWA (American Water Works Association) C105 and shall be provided with cathodic protection.
- e. Specify corrosion protection for buried ductile iron pressure piping and supports. All wrapping shall be site installed. Specify cathodic protection as necessary for local conditions.
- f. Local water purveyor, fire, or building department requirements for corrosion protection shall be incorporated into the project requirements.
- g. Continuous detectable warning tape shall be installed directly above all underground fire service line piping, approximately 1' below the finished grade surface.
- h. When backflow preventers are installed in fixed fire protection systems for new buildings, a test connection shall be provided downstream of all backflow prevention valves for flow tests at system demand.
- i. Provide valves in underground water distribution lines to isolate leaks and to allow water to supply the remainder of the loop. Locate isolation valves so that no more than five fire appurtenances are affected by shutdown of any single portion of the fire service main. Each fire hydrant, fire sprinkler system riser, and standpipe riser shall be considered a separate fire appurtenance.
- j. Steel piping having a corrosion-resistant ratio less than 1 is not permitted to be installed.
- k. Plain-end fittings shall not be permitted.
- l. Pressure seal-type fittings or methods of joining pipes shall not be permitted.

**DIVISION TWO:
TECHNICAL CRITERIA**

- 11 Architectural Criteria
- 12 Structural Criteria
- 13 Mechanical Criteria
- 14 Building Management System Criteria
- 15 Electrical Criteria
- 16 Lighting Criteria
- 17 Network and Communication Systems
- 18 Audiovisual Systems
- 19 Acoustical Criteria

**20 FIRE PROTECTION
CRITERIA**

- 20.A Objectives
- 20.B Fire Protection Criteria
- 20.C Fire Alarm System Objectives
- 20.D Fire Alarm System Criteria

- m. The automatic sprinkler system drainage piping shall be specified as galvanized steel pipe with galvanized threaded malleable iron fittings.
- n. Install above-ground pipe, fittings, and hangers in accordance with NFPA 13 and local code requirements, including seismic sway and uplift bracing.
- o. Make reductions in pipe sizes with one-piece reducing fittings. Bushings will not be acceptable, except when standard fittings of proper size are not manufactured.
- p. Earthquake protection and bracing shall be in accordance with NFPA 13. Other methods of bracing shall be permitted if certified by a California registered professional structural engineer.
- q. Exposed piping supplying chrome-plated hose valves or fire department connections shall be painted (color to be approved by architect). Chrome-plated wall or floor escutcheons shall be provided at point of concealment.
- r. Install a hinged chrome-plated escutcheon at all visible wall, floor, and ceiling pipe penetrations in finished areas.
- s. Do not run piping through elevator hoistways, machine rooms, machinery spaces, or enclosures unless piping is serving these spaces. Branch sprinkler piping serving those spaces shall be provided with a supervised branch shutoff valve located at an accessible location outside these spaces. Furnish a supervisory switch at these valves.
- t. Do not run piping through electrical rooms unless piping is serving these spaces. Coordinate piping layouts to prevent installation directly over electrical equipment. If pipe routing over equipment is unavoidable, provide drain pans under piping to prevent leaking pipe drips from damaging equipment while maintaining sprinkler coverage.

7. Piping Specialties

- a. Specify piping specialties that are UL listed and made by a single manufacturer.
- b. Specify pressure gauges to be 3-1/2" dial with a dial range of twice the system working pressure, 1/4" bottom connection, and shutoff valve.
- c. Specify flow switches with adjustable time delays, UL listed. Each must have two contacts for local and remote alarms, double pole, double throw (DPDT).
- d. Specify inspector's test and drain valve assembly in accordance with NFPA 13.
- e. Specify valve supervisory switches to be UL listed, 120VAC (volts of alternating current)/30 VDC (volts of direct current), with DPDT.
- f. Other specialty items shall be specified as by NFPA 13 or local conditions and codes.
- g. Specify the sprinkler heads to be UL-listed automatic sprinklers in accordance with the following:
 - Specify a temperature rating of 155 degrees Fahrenheit (°F)–165°F, except when the application requires a higher rating.
 - Specify a 200°F temperature rating for sprinkler heads in all switchgear rooms, electrical rooms, elevator machine rooms, mechanical rooms, and skylights, and where required by NFPA.
 - Provide detention-grade, ceiling-mounted sprinkler heads in all inmate-accessible areas. Sprinkler heads must meet Compliance Services and Assessments (CSA) standards for suicide prevention and be located a minimum of 8' above the finish

floor. The sprinkler heads come with a factory finish. Tyco sprinkler heads shall be the basis of design and pricing, with smooth underside and no protruding elements.

- Specify standard response-type sprinkler heads—upright, sidewall, or pendant—in open ceiling areas and in switchgear rooms, electrical rooms, elevator machine rooms, mechanical rooms, and other service areas.

8. Fire Department Connections

- Specify the fire department connections (FDC) to be provided in accordance with NFPA, California Fire Code, and local fire department requirements. Hose threads shall conform to the standards of the responding fire departments.
- The FDCs shall be cast brass or ductile iron body with drop clappers. Provide chrome-plated brass plate with lettering as required by the local fire authorities. Provide chrome-plated brass female snoots with hose thread swivels, of a style to meet local fire department requirements with threaded caps and chains. All hose inlets and threads shall meet National Standard Thread requirements and conform to local fire department requirements.

9. Valve Requirements

- Valves shall be UL listed, all with supervisory switches.
- Automatic sprinkler system control valves shall be located in accessible spaces; they are not permitted in above-ceiling spaces. Valves shall be accessible and shall not require special equipment to operate the control valves.
- Specify valves that are UL listed for the application and pressure classification and that are manufactured by companies with a full line of fire protection system components.

10. Post Indicator Valve (PIV) Assembly

When required by the local authorities, specify UL-listed PIV assembly. PIVs shall be monitored by the building fire alarm system.

11. Main Distribution Frame / Server Equipment Room Protection

Sprinkler heads shall be provided with sprinkler guards. A double interlock preaction sprinkler system is required. The dedicated preaction panel shall be connected to the building fire alarm system.

A preaction fire sprinkler system shall be provided for MDF and IDF rooms. The fire sprinkler system shall have a separate, dedicated, manually operated isolation valve with a supervisory switch and a separate flow switch located outside the protected area in an accessible location. Both the supervisory switch and the flow switch shall be connected to the building fire alarm system.

If approved by the Judicial Council, an automatic clean agent fire suppression system compliant with NFPA-2001 in high-value critical facilities rooms may be allowed. The detection system shall use cross-zone or counting-zone photoelectric detectors.

Activation of a minimum of two detectors is required before the agent discharge countdown sequence can begin. The quantity of detectors shall be determined by airflow within the hazard area, but the area protected shall not exceed 250 square feet per detector. Minimum detection to be provided for each clean agent protected room shall be two counting-zone detectors or two cross-zone detectors.

DIVISION TWO: TECHNICAL CRITERIA

11	Architectural Criteria
12	Structural Criteria
13	Mechanical Criteria
14	Building Management System Criteria
15	Electrical Criteria
16	Lighting Criteria
17	Network and Communication Systems
18	Audiovisual Systems
19	Acoustical Criteria
20	FIRE PROTECTION CRITERIA
20.A	Objectives
20.B	Fire Protection Criteria
20.C	Fire Alarm System Objectives
20.D	Fire Alarm System Criteria

The fire alarm system shall be coordinated with other specification sections, such as architectural, site utilities, plumbing, fire sprinkler, electrical, telephone, data, security, intelligent building, and mechanical systems.

12. Coordination

- a. Fire protection systems shall be coordinated with other specification sections, such as earthwork, architectural, site utilities, concrete, plumbing, structural, electrical, sheet metal, and mechanical sections.
- b. All electrical equipment provided under fire protection systems shall be specified with wiring diagrams for interfacing with electrical work.
- c. Coordinate automatic sprinkler systems with the building fire alarm system for transmitting all flow and tamper alarms.
- d. The edge-of-slab fire-rated UL system shall address general requirements for protection of steel per the Office of the State Fire Marshal. Specify how ratings are to be maintained where walls abut exterior window walls and/or columns.
- e. Specify that the OSFM may require sequential inspection of each component of the rated walls.
- f. Clearly define fire and temperature rating requirements and products for mechanical, electrical, and plumbing systems (e.g., piping and conduit), and for large banks of pipes, conduits, and bus ducts.

13. Guarantee

The fire protection work shall be free from defects of workmanship and materials for two years after filing notice of completion, and the general contractor shall remedy any defects developing during this period, free of charge. Manufacturers whose equipment has a longer guarantee period shall provide a written guarantee.

14. Installation Contractor Certification

Specify that the fire protection system shall require the installation contractor to submit all certificates in triplicate indicating approval of work, approval or performance of tests, and final inspection issued by the OSFM before final acceptance of the fire protection system.

15. Cleaning

Specify that the sprinkler heads placed before painting be covered with paper or plastic bags, which shall be removed only after painting is completed.

20.C FIRE ALARM SYSTEM OBJECTIVES

Fire alarm system design shall provide safe installation and operations through standardization, installation, and testing requirements based on sound engineering principles, applicable state and local codes, and field experience. These criteria set minimum acceptable requirements for design and installation of the building fire alarm system.

Designers shall use these criteria to develop fire alarm systems for construction of new buildings, retrofit of existing buildings, and interior renovation of existing buildings. When the criteria are applied to the design of interior renovations of existing structures, the designer shall provide systems that meet either the design parameters of the existing building fire alarm system or these criteria, whichever result in a system that satisfies applicable codes.

20.D FIRE ALARM SYSTEM CRITERIA

1. General Requirements

- a. The fire alarm and notification system shall be UL listed, State Fire Marshal listed and approved, and manufactured by firms regularly engaged in manufacturing fire detection, alarm, and communication systems; be of types, sizes, and electrical characteristics required; and use products that have been in satisfactory use in similar service for not less than five years. The fire alarm system shall be a fully addressable and nonproprietary system. Class B wiring shall be acceptable except for connections (signaling circuits) between the main fire alarm control panel and any networked remote fire alarm panels, where Class A wiring shall be provided. Minimum conduit size throughout the installation shall be 3/4".
- b. All fire alarm systems shall be designed by a California registered fire protection engineer; deferred-approval construction shop drawings may be prepared by a Class C-10 fire protection contractor.
- c. The fire alarm system shall be specified with the following:
 - For non-high-rise buildings, the fire alarm control panel shall be located in the security operations center unless another location is mandated by code. Provide a fire alarm remote annunciator inside the building in a location adjacent to the main entrance.
 - For high-rise buildings, the fire alarm panel and other equipment and documentation, as required by the California Fire Code, shall be located in the fire command center. It shall be shown in plans and elevations with all systems included. The layout shall be coordinated with the local fire department, and access shall be from within the building.
- d. Fire alarm systems shall include an emergency communication system (voice notification system) when any one of the following conditions exists:
 - The building is two or more stories in height above the level of exit discharge.
 - The total calculated occupant load of the building is 300 or more occupants.
 - The building is subject to 100 or more occupants above or below the level of exit discharge.
- e. The emergency communication system must provide an automatic voice message in response to the receipt of a signal indicative of a fire emergency. Manual control with the capability of making live voice announcements must also be furnished to provide occupants notification on either a selective or an all-call basis.
- f. All fire alarm signals (i.e., alarm, supervisory, and trouble signals) must be automatically transmitted to a UL-listed central station service using one or more of the methods allowed by NFPA 72, section 26.6. Operation of a duct smoke detector is permitted to initiate a supervisory signal.
- g. Manual fire alarm boxes must be installed in accordance with the requirements in NFPA 72 and the California Fire Code.
- h. Fire alarm control units and annunciators shall be semirecessed in finished areas.
- i. All wiring entering or exiting a fire alarm control panel must be clearly labeled marking destination or source and purpose (e.g., "Fan #22 Shutdown").
- j. In the event of primary power failure, all fire alarm systems shall be provided with

DIVISION TWO: TECHNICAL CRITERIA

- 11 Architectural Criteria
- 12 Structural Criteria
- 13 Mechanical Criteria
- 14 Building Management System Criteria
- 15 Electrical Criteria
- 16 Lighting Criteria
- 17 Network and Communication Systems
- 18 Audiovisual Systems
- 19 Acoustical Criteria

20 FIRE PROTECTION CRITERIA

- 20.A Objectives
- 20.B Fire Protection Criteria
- 20.C Fire Alarm System Objectives
- 20.D Fire Alarm System Criteria

battery backup power to accommodate a 24-hour standby load plus 15 minutes of alarm condition load.

- k. Smoke detectors must be installed in accordance with the requirements in NFPA 72 and the California Fire Code. Provide individually addressable smoke detectors appropriate for the application in the following locations: all elevator lobbies, uninterruptible power supply rooms, electrical switch gear rooms, transformer vaults, telephone exchanges, and elevator machine rooms. When smoke detection is installed in rooms having medium-voltage equipment, the smoke detection must not be installed directly above the medium-voltage equipment. MDF rooms containing server or mainframe computer equipment shall be provided with smoke detection connected to the fire alarm system, unless separate smoke detection provision (e.g., dedicated to clean agent systems detection or actuation) already exists.
- l. The requirement and placement of audible and visible notification devices within exit enclosures (stairways) and restrooms shall be reviewed by the Judicial Council and the OSFM on a case-by-case basis and is dependent on room size, use, furniture, and floor and ceiling finishes. The audible devices may be approved to be eliminated by the OSFM because of the potential of exceeding the allowable 110 dBA (A-weighted decibel). The visible notification devices may be approved to be eliminated by the OSFM because of the potential confusion that could occur within the exit enclosures. See CFC sections 907.5.2.1.2 and 907.5.2.3 and NFPA 72, section 18.4.4.2, for detailed requirements.
- m. All non-high-rise fire alarm systems must have an annunciator located near the primary fire department entrance to the building, except when the fire alarm control panel is already present in this location.
- n. Fire alarm system signaling line circuits shall be installed with isolation modules in sufficient number and location to limit the potential number of impaired devices from a single circuit failure to a maximum of eight devices.

2. Rational Analysis

- a. A rational analysis shall be performed and a report prepared to establish minimum requirements for the design, installation, and acceptance testing of smoke control systems that are intended to provide a tenable environment for the evacuation or relocation of occupants. The report and associated design, complying with the California Building Code, shall be submitted with the construction documents.
- b. Provide a smoke control system where required by code. Roll-down doors provided as part of smoke control in high-volume spaces shall have smoke control fire alarm position switches for the smoke control panel.
- c. Specifications shall describe the intent, scope, responsibilities, weekly testing, referenced specifications, and the like for the smoke control system. Include testing requirements for systems that use ductwork for both smoke exhaust and normal return. The smoke control ductwork pressure class shall be noted on supply, exhaust, and return systems. Define the testing requirements of the electric resettable link (ERL).

3. Quality Assurance

- a. All materials specified shall be the best available, new, and approved by UL and the California Office of the State Fire Marshal.
- b. All panels and peripheral devices shall be the standard product of a single fire alarm system manufacturer, under the appropriate UL category.

- c. Installer shall be qualified with at least five years of successful installation experience on projects with fire detection, alarm, and communication systems installation work similar to that required for the project.
- d. Comply with the California Energy Code, as applicable for construction and installation of fire detection, alarm, and communication system components and accessories.
- e. The fire detection, alarm, and communication system components and accessories shall comply with all federal and state standards.

4. Identification

Specify that the proper identification and signage be provided at each fire alarm panel, conduit, branch circuit, pull box, and junction box using industry-standard materials and methods.

5. Guarantee

The fire alarm work shall be free from defects of workmanship and materials for two years after filing notice of completion, and the general contractor shall remedy any defects developing during this period, free of charge. Manufacturers whose equipment has a longer guarantee period shall provide a written guarantee. Specifications shall include requirements for the fire alarm contractor to provide a minimum two-year warranty for all fire alarm systems. The fire alarm contractor shall provide required inspection, testing, and maintenance services at least every six months throughout the warranty period.

6. Tests and Adjustments

Specify that after installation has been completed, the entire system be tested in accordance with NFPA 72 by the contractor in the presence of the AHJ.

7. Installation Contractor Certification

Specify that the fire alarm system installation contractor shall submit all certificates in triplicate indicating approval of work, approval or performance of tests, and final inspection issued by local authorities.

**DIVISION TWO:
TECHNICAL CRITERIA**

- 11 Architectural Criteria
- 12 Structural Criteria
- 13 Mechanical Criteria
- 14 Building Management System Criteria
- 15 Electrical Criteria
- 16 Lighting Criteria
- 17 Network and Communication Systems
- 18 Audiovisual Systems
- 19 Acoustical Criteria

**20 FIRE PROTECTION
CRITERIA**

- 20.A Objectives
- 20.B Fire Protection Criteria
- 20.C Fire Alarm System Objectives
- 20.D Fire Alarm System Criteria

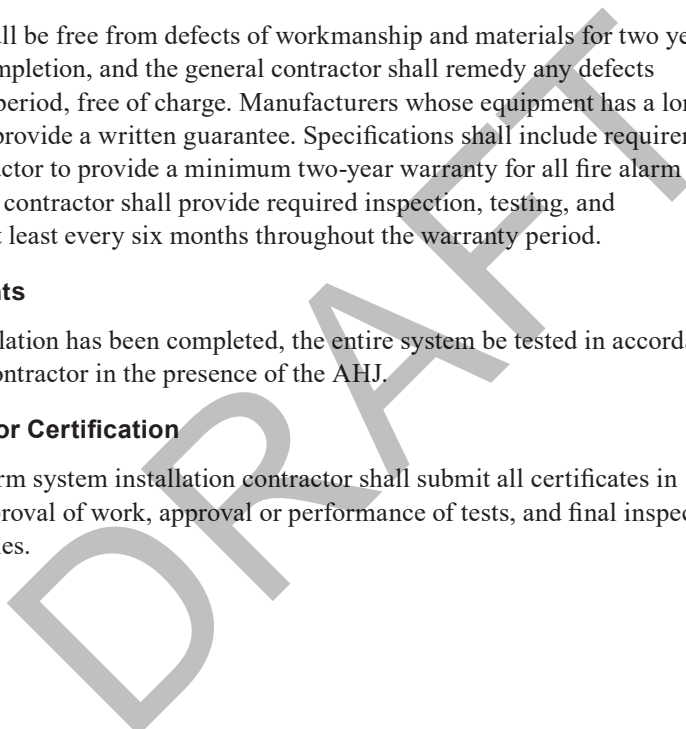

DRAFT

REQUIRED TOOLS

- T1 Life Cycle Cost Analysis
- T2 Catalog of Courtroom Layouts for California Trial Courts
- T3 Integrated Network Architecture
- T4 Graphical User Interface Template
- T5 In-Custody Interview Room Guidelines
- T6 Building Management System Guidelines

DRAFT

T1

REQUIRED TOOLS

LIFE CYCLE COST ANALYSIS

SECTION	TOPIC	PAGE
T1.A	Purpose	T1.2
T1.B	Principles	T1.3
T1.C	Performing LCCA	T1.11

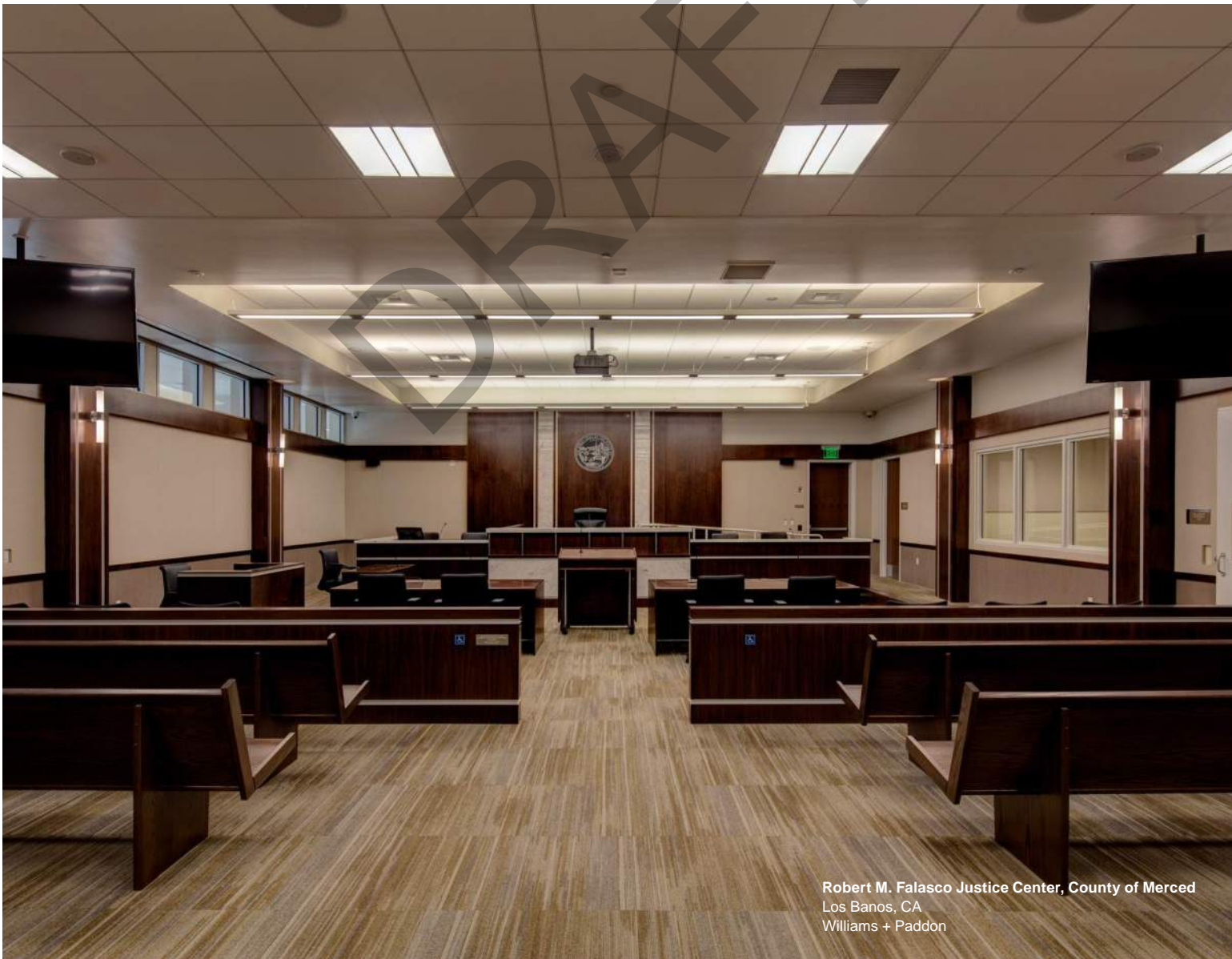

Robert M. Falasco Justice Center, County of Merced
Los Banos, CA
Williams + Paddon

T1.A PURPOSE

The life cycle cost analysis (LCCA) procedure documents the standardized process for conducting a life cycle cost analysis. LCCA is an economic assessment of an item, system, or facility considering all significant costs of ownership over an economic life, expressed in terms of equivalent costs. To ensure that costs are compared on an equivalent basis, the baselines used for initial cost must be the same as those used for all other costs associated with each option, including maintenance, operating cost, and replacement. LCCA is especially useful when comparing project alternatives that differ with respect to initial costs and operating costs in order to select the option that maximizes net savings.

LCCA is used to compare various options by identifying and assessing economic impacts over the whole life of each alternative. Future costs over the life of a facility—including operations, maintenance, and replacement—typically will match or exceed the initial cost of facility procurement. If staffing and other use costs are factored into the analysis, the initial procurement may be less than 20 percent of the total cost of ownership. Nearly every decision made during design and construction affects project costs. Some decisions are straightforward because they affect building performance or respond to codes and standards and their cost ramifications are apparent. Others are more subtle in their effect on cost and can profoundly affect disciplines and building systems beyond the prime decision maker, such as insulation or glazing choices, which affect building heating and cooling. Most design choices have a major effect on life cycle costs.

The Judicial Council expects designers to control future facility expenditures, while avoiding placing an undue burden on initial costs. The move toward sustainable design has highlighted the need for sensitivity to future cost. LCCA is an important tool in making more effective design decisions—ultimately for managing costs throughout the life of a facility, seeking optimum life cycle cost, and balancing functional needs with economic limitations. Figure T1.1 shows the comparison between low first cost versus optimum life cycle cost.

There will always be questions on how best to prioritize design choices. The overriding requirement is to optimize life cycle costs while maintaining cost management responsibility for the construction cost limitation.

This topic discusses methods for defining, estimating, and managing life cycle costs.

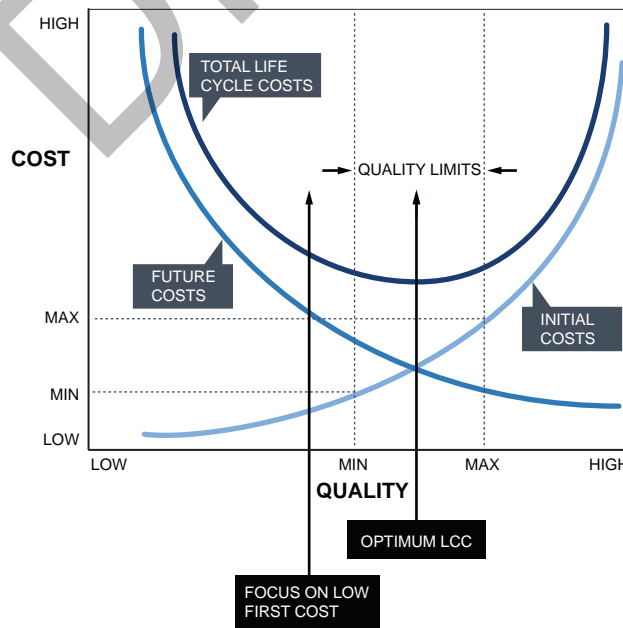

Figure T1.1 Life Cycle Cost Curve

T1.B PRINCIPLES

In making decisions, both present and future costs need to be taken into account and related to one another. A dollar today is not equal to a dollar tomorrow. Money invested in any form has the capacity to earn interest. A current dollar is always worth more than the prospect of a dollar at some future time. The exact amount depends on the investment rate (interest or the cost of money) and the length of time. This relationship—that money has the power to earn more money—is fundamental to economic analysis and LCCA.

The terms *interest rate* and *discount rate* are generally used synonymously. *Interest* is more commonly used in financial analyses, whereas *discount* is more often used in economic studies. Both terms refer to the annual growth rate for the time value of money.

At a 5 percent discount rate, a dollar will grow in value by a factor of approximately 3.5 over a 25-year period; at a 15 percent discount rate, the factor is nearly 35. Even though the discount rates differ by a factor of 3, the resulting relationship in value differs by a factor of nearly 10. The selection of a discount rate is important to an LCCA.

What does the term *real discount rate* mean? Inflation can affect an economic analysis because over time it reduces the purchasing power of currency. This effect means that more currency in the future will be required to purchase the same goods.

General inflation does not directly affect the actual time value of money because, under all circumstances, money must have a time value. Inflation, however, does affect how the time value is calculated and must be accommodated in the calculation. So, if the real time value of money is 5 percent and inflation is predicted to be 3 percent, then any discounting analysis would need to use 8 percent as an interest rate and inflate all future costs by 3 percent. This is called a *current dollars analysis*.

As a simplification, especially in comparative analyses not used for cash flow calculations, constant dollars may be used. In this case, a 5 percent discount rate would be used and all future costs would be held at the base date relative cost and not inflated.

For all Judicial Council analyses, a real discount rate (exclusive of inflation) of 3.25 percent will be used unless otherwise directed.

The one exception for an adjustment to a real discount rate would be for any future costs expected not to follow inflation. For example, energy costs have tended to increase at 1 to 2 percent above inflation over the last 10 years. In this case, future energy costs would be inflated differentially (above the general inflation rate) by 1 to 2 percent. This effect is referred to in economic analyses as *escalation*.

1. Economic Analysis Period

The economic or study period used when comparing alternatives is an important consideration. Predicting future costs for 25 to 40 years is usually long enough to capture the most significant costs for economic purposes. Nearly 90 percent of the total present value equivalent cost is consumed in the first 25 years at a 5 percent discount rate. For this reason, periods longer than 40 years generally add little benefit to an LCCA unless very low (below 2 percent) interest rates are used.

The Judicial Council requires a 30-year economic analysis period unless there is a specific reason to deviate.

REQUIRED TOOLS

T1 LIFE CYCLE COST ANALYSIS

T1.A Purpose

T1.B Principles

T1.C Performing LCCA

T2 Catalog of Courtroom Layouts for California Trial Courts

T3 Integrated Network Architecture

T4 Graphical User Interface Template

T5 In-Custody Interview Room Guidelines

T6 Building Management System Guidelines

2. Life of an Element

A time frame must also be identified for each system or component under analysis relative to the overall study period. The *technological life* of an item is the estimated number of years until technology causes the item to become obsolete. The *useful life* of an item is the estimated number of years during which it will perform its function according to some established performance standard. The *economic life* of an item is the estimated number of years until that item no longer represents the least expensive method of performing its function.

The economic life of an item is the most important of the three, from the viewpoint of cost optimization. It is also generally the shortest, with the exception of consequential technological changes that bring in new solutions at much lower cost. However, the technological and useful lives of an item should still be considered when its economic life is estimated.

Extending the life of an item beyond its economic life in an LCCA is generally economically neutral or negative. For example, a rooftop heating, ventilation, and air-conditioning (HVAC) component can operate past its 20-year economic life but will require above-normal maintenance, is more likely to fail, and will use more energy. The result in terms of total life cycle cost will be similar to simply allowing for replacement at the 20th year.

For all Judicial Council analyses, the economic life of systems or components will be used unless otherwise directed.

Table T1.1 provides guidelines for the economic life of building components. Various sources were used for the table, including *Life Cycle Costing for Facilities* by Alphonse J. Dell'Isola and Steven J. Kirk (RSMMeans, 2003).

3. Categories of Cost

Over the life of a facility, costs will be expended on a broad range of components and for numerous purposes. A life cycle cost analysis is a comparative analysis; therefore, it is important that costs be properly identified and categorized ***so that common items can be eliminated from the analysis and effort can be focused on the difference between critical items.***

The costs of owning a facility can be subdivided as follows:

- Initial costs
 - Construction
 - Fees
 - Environmental review and mitigation
 - Other initial costs
- Future facility one-time costs
 - Replacements
 - Alterations
 - Salvage
 - Other one-time costs
- Future facility annual costs
 - Operations including utilities

Table T1.1 Economic Life of Building Components

COMPONENT	ECONOMIC LIFE (YEARS)
General Construction (Divs. 2–14)	
Foundations	30(+)
Substructure	30(+)
Superstructure	
Steel	30(+)
Masonry	30(+)
Cast-in-Place Concrete	30(+)
Pre-cast Concrete	50–100
Exterior Closure	
Masonry	30
Wood	20
Precast	25
Steel/Aluminum Curtain Wall	30
Glazing Systems	25
Sun Control Devices	15
Roofing	
Built-up	17
EPDM Single-ply	20
Interior Construction	
Drywall Partitions on Metal Studs	20
Masonry Interior Walls	30
Interior Finishes	10–20
Conveying Systems	
Passenger Elevators	30
Escalators	20
Equipment	10–20

EPDM = ethylene propylene diene monomer.

VAV = variable air volume.

COMPONENT	ECONOMIC LIFE (YEARS)
Mech/Elect Construction (Divs. 21–28)	
Plumbing	
Piping	30
Fixtures	20–30
Hot Water Heater	25
Roof Drainage	30
Air Conditioners	
Water-cooled Package	15
Computer Room	15
Rooftop Multizone	20
Boilers	
Steel/ Cast Iron	25
Electric	15
Furnaces: Gas or Oil-fired	18
Unit Heaters	
Gas or Electric	12
Hot Water or Steam	20
Air Terminals	
Diffusers, Grilles, and Registers	25
Fan Coil Units	20
VAV Boxes	20
Duct Work	30
Fans	20–25
Chillers	20–25
Cooling Towers	20–25
Pumps	15–20
Controls	15–20
Electric Motors	15
Motor Starters	17
Branch Circuits and Wiring Devices	20
Switchgear	20
Liquid-filled Transformers	30
Dry-type Transformers	25
Interior Lighting Systems	20
Communication Systems	15–20
Engine/Generators	20
Turbine/Generators	25
Solar Panels	30

REQUIRED TOOLS

- T1 LIFE CYCLE COST ANALYSIS
 - T1.A Purpose
 - T1.B Principles
 - T1.C Performing LCCA
- T2 Catalog of Courtroom Layouts for California Trial Courts
- T3 Integrated Network Architecture
- T4 Graphical User Interface Template
- T5 In-Custody Interview Room Guidelines
- T6 Building Management System Guidelines

- Maintenance
- Financing
- Taxes
- Insurance
- Security
- Utility rate escalation
- Other annual costs
- Functional-use costs
 - Staffing
 - Materials
 - Denial of use
 - Other functional-use costs
- Environmental costs
 - Water scarcity
 - Ongoing environmental mitigation
 - Other environmental costs

Initial costs include construction, fees, and costs such as land acquisition and moving. These represent up-front costs associated with facility development. Future one-time costs represent major expenditures that are not annual (although they may be periodic) and include replacement, elective alterations, and salvage.

Facility annual costs include all costs to run the facility itself, such as operations, maintenance, and other built environment costs.

Functional-use costs are costs associated with using a facility, including staffing, materials, and any other nonfacility costs. Items such as denial-of-use costs may be necessary during construction and may include temporary space, operations, and added security.

Additionally, environmental costs shall be considered when doing the LCCA. Future site water scarcity, ongoing environmental mitigation, and other environmental costs shall be considered in conjunction with initial environmental review and mitigation costs to determine the appropriate building parameters.

4. Life Cycle Costing Procedures

Life cycle costing focuses on comparing competing alternatives. To compare alternatives, both present and future costs for each alternative must be brought to a common point in time using one of two methods: costs may be converted into today's costs by the *present-worth method*, or they may be converted to an annual series of payments by the *annualized method*. Either method will properly allow comparison between alternatives.

4.1 Present-Worth Method

The present-worth method requires conversion of all present and future expenditures to a baseline of today's cost. Initial (present) costs are already expressed in present worth. Future costs are converted to present value by applying the factors presented previously.

4.2 Annualized Method

The annualized method converts initial, recurring, and nonrecurring costs to an annual series of payments and may be used to express all life cycle costs as an annual expenditure.

Mortgage payments are an example of this procedure.

4.3 Other Economic Analysis Methods

Other methods of economic analysis can be used in a life cycle study, depending on the client's requirements and special needs. It is possible to determine the payback period, to establish a break-even point between alternatives, to determine the rate of return on total investment and extra investment, to determine rate-of-return alternatives, to perform a cash flow analysis, and to review the benefits and costs.

All methods, correctly applied, will yield results pointing to the same conclusion.

The Judicial Council requires the present-worth analysis to be used for LCCA.

5. Accuracy Requirements for LCCA

To perform a life cycle cost analysis, certain assumptions must be made. These assumptions concern significant economic variables, including discount rate, study duration, and escalation, as well as data defining the cost and performance of competing alternatives. Seldom are clear-cut, obvious, and easy choices available. Invariably, good judgment, experience, and common sense need to be used in making decisions. The following guidelines should be considered:

- Issues common to all alternatives can be ignored. The objective of LCCA is to select between competing alternatives. Therefore, assumptions need to be made and data that are sufficient to distinguish performance need to be gathered only for issues that differ between the alternatives.
- In general, because of likely margins of error in estimating costs, alternatives would have to exhibit a life cycle cost (LCC) differential greater than 10 percent to be judged conclusive. Numeric accuracy should be balanced between the need to differentiate the alternatives and the dependability of input information. Much of the LCC data available have been gathered from observation and are inherently highly variable.
- A sensitivity analysis should be considered whenever assumptions may be deemed questionable. Even when differentials exceed 10 percent, confidence in major variables in the analysis may limit confidence in the overall conclusions. In these instances, a sensitivity analysis may be required. It involves conducting multiple LCCAs using extremes of the cost parameters in question and evaluating the resulting sensitivity of the analysis to the assumptions. To reach the same overall conclusion even when assumptions are significantly varied is not uncommon.

6. Typical Areas of Study

The areas of study for an LCCA will vary among facilities and, to some degree, by geographic location. Table T1.2 lists components that are typically selected for study and provides some general areas for consideration.

REQUIRED TOOLS

T1	LIFE CYCLE COST ANALYSIS
T1.A	Purpose
T1.B	Principles
T1.C	Performing LCCA
T2	Catalog of Courtroom Layouts for California Trial Courts
T3	Integrated Network Architecture
T4	Graphical User Interface Template
T5	In-Custody Interview Room Guidelines
T6	Building Management System Guidelines

Table T1.2 Typical Components to Be Considered in a Life Cycle Cost Analysis

COMPONENT	TYPICAL ALTERNATIVES TO BE ANALYZED
Predesign	
	Impacts of new acquisition, leasing and/or public-private partnerships
	Renovation, upgrade, or revitalization of an existing facility
	Use of other state facilities
General Life Cycle Cost Issues for All Components	
	Element/component service and replacement life
	Maintenance and maintainability
	Direct and indirect energy impacts
Site and Program	
	Building shape and orientation on the planned site (including impact on adjacent buildings)
	Alternative sites
	Seismic, environmental, and community issues
Architecture	
Substructure	
	Foundations—Water infiltration, special seismic features
	Slab on grade—Special loads, vibration isolation
	Basement excavation—Use of import/export materials
	Basement and retaining walls—Water infiltration
Superstructure	
	Floor construction—Seismic impacts, floor displacement, noise isolation, security
	Roof construction—Seismic impacts
	Stair construction—Long-term maintainability, safety
Wall construction	
	Increased insulation levels, insulation placement, etc.
	Mass (passive solar thermal storage)
	Daylighting
	Building envelope (exterior closure) type
Fenestration	
	Type, amount, and location/orientation of glass
	Indoor/outdoor shading devices
	Daylighting
Interior space plan	
	Space arrangement and circulation
	Demising walls and partitions
	Finishes and colors
	Ceiling and plenum heights

Table T1.2 continues on next page

Table T1.2 Typical Components to Be Considered in a Life Cycle Cost Analysis *continued*

COMPONENT	TYPICAL ALTERNATIVES TO BE ANALYZED
Architecture (continued)	
Roof construction	
	Increased insulation levels, type of insulation
	Roof membrane type and color
	Daylighting
Conveyances	
	Selection of elevators and dumbwaiters
	Escalators
Secondary HVAC systems	
	System types and zoning
	Operating plans, economizer cycle(s) and optimization
	Heat recovery (exhaust air, internal source, etc.)
	Controls
Primary HVAC systems	
	System types and energy sources
	Pumping/piping configuration
	Heat recovery (waterside economizer cycle, etc.)
	Thermal storage (electrical demand shifting)
	Controls
Plumbing	
	Domestic hot water generation (method and energy source)
	Water source—Municipal, well, or harvested
Electrical	
Lighting and communications	
	System selection
	Artificial lighting levels, methods, and control
	Daylighting
	Photovoltaic sources
	Communications and data management
Power	
	Voltage selection (building and large equipment)
	Transformers (quantity, locations, efficiencies)
	Emergency power

REQUIRED TOOLS

- T1 LIFE CYCLE COST ANALYSIS**
- T1.A Purpose
- T1.B Principles
- T1.C Performing LCCA
- T2 Catalog of Courtroom Layouts for California Trial Courts
- T3 Integrated Network Architecture
- T4 Graphical User Interface Template
- T5 In-Custody Interview Room Guidelines
- T6 Building Management System Guidelines

7. Sources of Life Cycle Cost Data

Obtaining life cycle cost data is a challenge. Even when data are available, their applicability to a specific project may be questionable. That said, several sources of LCC data are available, including *Cost Planning and Estimating for Facilities Maintenance*, an annual publication of RSMeans; *Life Cycle Costing for Facilities*, an RSMeans publication; and CBRE’s CostLab system.

8. Design and Analysis Tools

The use of computer tools can considerably reduce the time and effort spent on formulating the LCCA, performing the computations, and documenting the study. The Judicial Council will provide an Excel spreadsheet for use with LCCA efforts.

As an alternative, the Building Life Cycle Cost Program—an economic analysis tool developed by the National Institute of Standards and Technology for the U.S. Department of Energy’s Federal Energy Management Program—can be used.

9. LCCA Study Requirements

LCCA studies are required for the major systems and components of court facilities that are energy and maintenance sensitive. Refer to table T1.3 for general guidance on the number of studies to be conducted based on the size of the courthouse. The number of studies required is determined on a project-by-project basis with direction from the Judicial Council. Typically, these studies would include the following systems, and each system shall be individually counted as a study.

- HVAC systems;
- Impact on overall building from seismic structural systems;
- Electrical lighting;
- Electrical power distribution;
- Flooring systems;
- Exterior closure;
- Fenestration;
- Solar panels; and
- Water distribution.

Table T1.3 Number of LCCA Studies by Size of Courthouse

Number of Courtrooms	≤4	5–7	8–14	>14
Number of LCCA Studies Expected	1–2	2–3	2–4	3–5

10. Conducting an LCCA

An important aspect in LCCA is identifying appropriate alternatives and establishing good cost data.

Step 1: Identify alternatives.

The types of alternatives considered depend on the creativity of the design and management teams. The baseline and alternatives should represent a wide range of solutions to the identified objectives. It is often helpful to use an interdisciplinary team during this stage to draw from a wide range of backgrounds, perspectives, and past experiences. Developing specific criteria to measure the effectiveness of the proposed alternatives is also helpful.

Step 2: Define parameters.

The discount rate (3.25 percent) and analysis period (30 years) are defined by the Judicial Council. Any variations must be approved before an LCCA may be conducted.

Life expectancies for individual elements or components being studied are expected to be defined by the design or design-build team.

Differential escalation rates for energy are built into the LCCA Excel spreadsheet form (and the Building Life Cycle Cost (BLCC) program) and are a function of the fuel type being consumed. Escalation rates for all other components of the analysis are up to the design or design-build team.

Step 3: Identify costs and savings.

Typically, two types of costs—nonrecurring and recurring—must be estimated. A nonrecurring cost appears as a lump sum cost in the present or at a fixed point in the future. An example of a nonrecurring cost is the capital expenditure for a new high-efficiency chiller unit.

Recurring costs are paid out periodically over the lifetime of the facility. An example of a recurring cost is a capital cost that is expected to occur in the future. Repair or maintenance costs that occur on a regular basis are also considered to be recurring costs.

Step 4: Document baseline and alternatives.

Assumptions and cost information should be documented, along with eventual recommendations. The evaluation form shown in table T1.4 provides an approach. Most efforts can be defined on a single page.

Step 5: Perform the LCCA.

Use the Excel spreadsheet provided by the Judicial Council to prepare an analysis for the system being evaluated. Alternatively, the BLCC program can be used. See table T1.5 for instructions, followed by table T1.6 and figure T1.2 for an example project.

Step 6: Provide documentation for review and acceptance.

Provide forms; exhibits, as necessary; and the Excel spreadsheet—all in PDF form.

T1.C PERFORMING LCCA

1. Overview

The life cycle cost analysis worksheet is a simple spreadsheet for use in comparing up to three options against a baseline design case to determine financial performance and life cycle cost. This spreadsheet is useful for identifying options for further study. It is not intended to provide a complete and detailed study, especially one representing cash flow.

REQUIRED TOOLS

T1 LIFE CYCLE COST ANALYSIS

T1.A Purpose

T1.B Principles

T1.C Performing LCCA

T2 Catalog of Courtroom Layouts for California Trial Courts

T3 Integrated Network Architecture

T4 Graphical User Interface Template

T5 In-Custody Interview Room Guidelines

T6 Building Management System Guidelines

2. Limitations

The spreadsheet does not consider effects of depreciation, tax alternatives, variable escalation of interest rates over a period of time, or other factors that may change the valuation or payback of an asset. It is suggested that studies be limited to a maximum 40-year cycle and whole percentage escalation rates up to 5 to 7 percent.

3. Reporting

Reports are formatted for printing and presentation on 8.5" × 11" paper in landscape format. Two pages total are provided for presentation. Normally only the results from the template pages are presented for use.

The output is provided in a format that meets most Judicial Council, General Services Administration, and other federal requirements for analysis.

4. Basics

Macros must be enabled for the spreadsheet to function properly. If some of the cells indicate *?NAME#*, macros have not been activated in the spreadsheet. Also, some cells may display *#DIV/0!* before key data are entered. These codes will disappear when data are entered.

A baseline design condition or scope of work must be entered for comparison and evaluation. Payback Period, Net Savings, and other items are calculated relative to the value of the baseline condition. All worksheets are protected, and data are to be entered in the pale blue cells. Results are provided as tabular comparisons and graphical representations of total cost of ownership.

5. Contents

Table T1.5 provides instructions for completing the life cycle cost analysis worksheet. An example project worksheet is provided after the instructions.

DRAFT

Table T1.4 Life Cycle Cost Analysis Evaluation Form

LCCA EVALUATION FORM
System Evaluated:
Describe baseline system as currently considered:
Define Alternative 1:
Define Alternative 2:
Define Alternative 3:
RECOMMENDATION & RATIONALE SUMMARY
Identify recommended approach:
Define key advantages:
Assess any disadvantages:
ATTACH APPROPRIATE EXHIBITS AND LCCA SPREADSHEET RESULTS

REQUIRED TOOLS

- T1 LIFE CYCLE COST ANALYSIS**
- T1.A Purpose
- T1.B Principles
- T1.C Performing LCCA
- T2 Catalog of Courtroom Layouts for California Trial Courts
- T3 Integrated Network Architecture
- T4 Graphical User Interface Template
- T5 In-Custody Interview Room Guidelines
- T6 Building Management System Guidelines

Table T1.5 LCC General Purpose Worksheet Instructions

Contents		
Worksheets include:		
READ FIRST—An introduction and summary of features and instructions for use		
Present Value (PV) Annuity—Calculation table of PV factors for an escalated equal annuity series used in support of main sheet		
LCC-Form Template—Blank template for use		
Sample Analysis—Completed spreadsheet sample for reference		
LCC-Form Template HIDE—Hidden version of template sheet for recovery, if main sheet is accidentally deleted or corrupted		
For Further Study		
<i>Architect’s Essentials of Cost Management</i> by Michael D. Dell’Isola, ISBN 0-471-44359-X		
<i>Life Cycle Costing for Facilities</i> by Alphonse J. Dell’Isola and Stephen J. Kirk, ISBN 0-87629-702-5		
Instructions		
Instructions for use are presented by specific worksheet as listed below starting with Read First.		
General Economic Notes		
It is suggested that the user conduct the study using <i>constant dollars</i> , where the purchasing power of the dollar is held constant as of the date of the study, and <i>discount rates</i> are “real,” excluding general inflation. Thus, an item costing \$1,000 today would be replaced in the future at \$1,000. Any real escalation or de-escalation is handled separately.		
If the user wishes to operate in <i>current dollars</i> , then future expenditures must be inflated individually, and the discount rate must be increased to include general inflation.		
The results are nearly identical unless inflation rates are extreme—over 15 percent.		
Worksheet	Cell Reference	Required Information
General		Cells with a light grey background are for entry of information for the analysis. The background color of the cells may be removed or changed following data entry.
DO NOT ADD ANY ROWS ABOVE ROW 6		
Worksheet Protection		The worksheets are protected against accidental overwriting or deletion of formulae. There is no password for the protection; it may be turned off (via Tools > Protection > Unprotect Sheet) to allow changes in formatting, if desired.
READ FIRST		No specific entry required.
PV Annuity	M2	Input Discount Rate. This sheet does not affect the calculations on the template or sample workbooks. These sheets are provided purely for reference, to show in tabular form the PV factors and effects.
PV Single	M2	Input Discount Rate. This sheet does not affect the calculations on the template or sample workbooks. These sheets are provided purely for reference, to show in tabular form the PV factors and effects.
LCC-Form Template		Copies of the template can be made for various alternatives and added as new worksheets to the file.

Table T1.5 continues on next page

Table T1.5 LCC General Purpose Worksheet Instructions *continued*

Worksheet	Cell Reference	Required Information
Option Names	K1, M1, O1, Q1	Input Option Names and Titles. Names of the Base Design and Options will be presented on the graphs and printed reports.
Project	C2	Input Project.
Title	D3	Input title of study and report.
Discount Rate	D4	Input Discount Rate for the study. This rate is 3.25 percent, as required by the Judicial Council. Alternative rates must be approved before the study. Note: This requirement assumes a “real” discount rate exclusive of inflation.
Date	G4	Input date of study.
Study Period	D5	Input period of analysis in years as a whole number—40 years maximum. Note that the Judicial Council requires a study period of 30 years. Alternative periods must be approved before the study.
Energy Location	G5	Dropdown menu for energy location for the study. Choose “West Commercial” as required by the Judicial Council. Energy escalation will be calculated from FEMP data. Alternative rates must be approved before the study.
Initial Costs	Rows 7–16	Input description of cost items and first costs for various options considered. Costs are entered in columns K, M, O, and Q for the various items. Multiple cost items may be added to reach the total first cost of the various options. Since these items are first cost and not subject to the financial analysis and discounting procedure, they should sum to the value of the work being estimated. Use the Escalation Factor for initial costs only when directed.
Replacement Costs	Rows 21–30	<p>Input description of cost items and current costs for various options considered. These items are generally SINGLE (not annual) expenditures during the life of the study. Enter either year of replacement for single-cost item OR number of years between replacement or upgrades to equipment and materials being provided in columns G or H. Only one of these values can be provided for each cost item.</p> <p>Enter assumed escalation or inflation rate for the study period in column I. This is to be an approximate value that will be applied for the entire period of the study.</p> <p>Costs for work items are entered in columns K, M, O, and Q for the various items. Multiple-cost items may be added to reach the total first cost of the various options. These values are entered as current market value and will be escalated to account for inflation and discounted based on the provided Discount Rate.</p> <p>Assumed salvage or residual value may be included here as a negative number. If the value results in a negative PV cost in this category, the graph will show this value and plot it below the X-axis (green bar).</p> <p>Salvage values are usually insignificant and ignored.</p>

REQUIRED TOOLS

- T1 LIFE CYCLE COST ANALYSIS**
- T1.A Purpose
- T1.B Principles
- T1.C Performing LCCA
- T2 Catalog of Courtroom Layouts for California Trial Courts
- T3 Integrated Network Architecture
- T4 Graphical User Interface Template
- T5 In-Custody Interview Room Guidelines
- T6 Building Management System Guidelines

Table T1.5 continues on next page

Table T1.5 LCC General Purpose Worksheet Instructions *continued*

Worksheet	Cell Reference	Required Information
Annual Costs	Rows 34–45	<p>Input description of cost items and current costs for various options considered. These items are generally recurring annual costs. Examples include annual energy usage costs, annual recurring maintenance costs, filter changes, and other costs that are incurred over the life of the asset.</p> <p>Escalation Rates:</p> <p>Energy costs can be escalated using the Federal Energy Management Program (FEMP). Select from the dropdown menu in column F.</p> <p>Other Annual Costs such as maintenance or special energy costs separate from FEMP can have escalation entered as a numeric percentage in column I.</p> <p>For any annual cost, differing start/stop years can be used. This approach is most appropriate for maintenance costs, which can vary from year to year.</p> <p>Costs for work items are entered in columns K, M, O, and Q for the various items. Multiple-cost items may be added to reach the total first cost of the various options. These values are entered as current market value and will be escalated to account for inflation and discounted based on the provided Discount Rate.</p>
Building Metrics	Rows 56–58	Input building information relative to size and number of seats or occupants.
Operation Cost Sensitivity	Row 64	<p>Normally self-calculating. In cases where fewer than three options are being presented, the formulae in these cells will need to be manually adjusted. These cells calculate an average of the operations expenditures and compare each of the alternatives to one another. A factor higher than 1 means that the present value will be affected by a change in annual (or energy) costs more than other options. A value below 1 means that the option will be less affected by a change in annual (or energy) costs.</p> <p><i>One or more of these values should ALWAYS be less than 1. If this is not the case, the formula reference to the “0” value cell must be removed to avoid incorrectly lowering the average.</i></p>
Summary and Recommendations	H97	Enter a brief description of summary conclusions from the analysis.

Table T1.6 Example Project

LCCA EVALUATION FORM
<p>System Evaluated:</p> <p>Evaluate different mechanical systems to determine the best system for the facility, including initial cost, maintenance cost, and efficiency</p>
<p>Describe baseline system as currently considered: VAV with current central plant efficiency</p> <p>Variable air volume (VAV) air handlers use energy recovery wheel to precondition outside air. Variable volume terminal units use 140°F to 180°F hot water for reheat. The existing chiller plant capacity will be increased with no efficiency changes.</p>
<p>Define Alternative 1: Decoupled with current central plant efficiency</p> <p>Dedicated outside air units will provide the code minimum of fresh air or makeup air to spaces. Dedicated outside air will be at lower temperatures to help offset some of the cooling loads. Multiple 4-pipe fan coil units will provide individual space conditioning for both heating and cooling.</p>
<p>Define Alternative 2: Decoupled + displacement ventilation with current central plant efficiency</p> <p>In addition to Alternative 1, displacement ventilation systems would be used for air distribution in tall spaces and concourses. Ventilation systems will be routed under the floor to air devices in double-height spaces or taller. Assume most air devices from the displacement ventilation systems will be custom style integrated into architectural design.</p>
<p>Define Alternative 3: Decoupled + displacement ventilation with current central plant efficiency and wider comfort definition</p> <p>See Alternatives 1 and 2 above for descriptions that would use 75°F cooling and 72°F heating space temperatures. Alternative 3 would evaluate cooling temperatures up to 76°F and heating temperatures down to 68°F. Alternative 3 would use spot fans to provide localized air movement.</p>
RECOMMENDATION & RATIONALE SUMMARY
<p>Identify recommended approach:</p> <p>Recommend that the new facility HVAC systems use Alternative 2 with a combination of decoupled + displacement ventilation with current central plant efficiency</p>
<p>Define key advantages:</p> <ul style="list-style-type: none"> • Lowest energy costs and life cycle costs
<p>Assess any disadvantages:</p> <ul style="list-style-type: none"> • Slightly higher installation costs
ATTACH APPROPRIATE EXHIBITS AND LCCA SPREADSHEET RESULTS

REQUIRED TOOLS

T1	LIFE CYCLE COST ANALYSIS
T1.A	Purpose
T1.B	Principles
T1.C	Performing LCCA
T2	Catalog of Courtroom Layouts for California Trial Courts
T3	Integrated Network Architecture
T4	Graphical User Interface Template
T5	In-Custody Interview Room Guidelines
T6	Building Management System Guidelines

Figure T1.2 Life Cycle Study Template

Life Cycle Cost Analysis - General Purpose Worksheet							Base Design		Option 1		Option 2		Option 3		
Project: Large Scale Facility Example							VAV with current central plant efficiency		Decoupled with current central plant efficiency		Decoupled + displacement ventilation with current CP efficiency		Decoupled + displacement ventilation with current CP efficiency and wider comfort definition		
Study Title: Evaluate different mechanical systems							Estimated Costs	Present Value	Estimated Costs	Present Value	Estimated Costs	Present Value	Estimated Costs	Present Value	
Discount Rate: 3.25%		Date: May 1, 2020													
Study Period (Yrs.): 30		Energy Loc: West Commercial					Estimated Costs	Present Value	Estimated Costs	Present Value	Estimated Costs	Present Value	Estimated Costs	Present Value	
Capital Expenditures (CAPEX)	Initial / First / Collateral Costs														
	A. VAV current eff. initial costs						10,136,400	10,136,400							
	B. Decoupled w/ current initial costs								10,773,000	10,773,000					
	C. Dec+Disp initial costs										11,211,800	11,211,800			
	D. Dec+Disp, comfort initial costs												11,237,800	11,237,800	
	E.														
	F.														
	G.														
	H.														
	I.														
J.															
Total Initial/Collateral Costs						\$10,136,400	\$10,136,400	\$10,773,000	\$10,773,000	\$11,211,800	\$11,211,800	\$11,237,800	\$11,237,800		
Difference									(\$636,600)		(\$1,075,400)		(\$1,101,400)		
Operations Expenditures (OPEX)	Replacement / Salvage (Single Expenditures)														
	A. Misc Repairs														
	B. Misc Repairs														
	C. Misc Replacements														
	D. Misc Replacements														
	E. Misc Replacements														
	F.														
	G.														
	H.														
	I.														
	J.														
	Total Replacement/Salvage Costs							\$1,269,768		\$1,357,794		\$639,869		\$666,182	
	Annual Costs														
	Energy (Using FEMP Escalation):														
	A. Annual Energy														
B.															
C.															
D.															
E.															
Other Annual Costs (Enter Escalation Rate):															
F. Annual Maintenance / Service															
G.															
H.															
I.															
J.															
K.															
Total Annual Costs						\$564,800	\$10,844,716	\$526,900	\$10,170,465	\$359,800	\$7,006,815	\$354,000	\$6,897,005		
Sub-Total Replacement/Salvage + Annual Costs (Present Value)							\$12,114,484		\$11,528,258		\$7,646,684		\$7,563,188		
Difference - Compared to Base Design									\$586,225		\$4,467,799		\$4,551,296		
Life Cycle Cost	Total Life Cycle Costs (Present Value)							\$22,250,884		\$22,301,258		\$18,858,484		\$18,800,988	
	Difference - Life Cycle Cost PV Compared to Base Design									(\$50,375)		\$3,392,399		\$3,449,896	
	Payback - Simple Discounted (Added Cost / Annualized Savings)									N/A		4.6 Yrs.		4.6 Yrs.	
	Payback - Fully Discounted (Added Cost+Interest / Annualized Savings)									N/A		5.0 Yrs.		5.1 Yrs.	
Total Life Cycle Costs - Annualized						Per Year:	\$1,172,215	Per Year:	\$1,174,869	Per Year:	\$993,497	Per Year:	\$990,468		

Life Cycle Cost Analysis - General Purpose Worksheet

		Base Design	Option 1	Option 2	Option 3
Project:	Large Scale Facility Example	VAV with current central plant efficiency	Decoupled with current central plant efficiency	Decoupled + displacement ventilation with current CP efficiency	Decoupled + displacement ventilation with current CP efficiency and wider comfort definition
Study Title:	Evaluate different mechanical systems				

Other Comparison Metrics

Total Building Gross Square Footage	70,000
Total Building Net Usable Footage	50,000
Total Seats or Occupants	400

PV per GSF	\$ 317.87	\$ 318.59	\$ 269.41	\$ 268.59
PV per NSF	\$ 445.02	\$ 446.03	\$ 377.17	\$ 376.02
PV per Seat	\$ 55,627.21	\$ 55,753.15	\$ 47,146.21	\$ 47,002.47
Annual Cost per Seat	\$2,930.54	\$2,937.17	\$2,483.74	\$2,476.17
First Cost (CAPEX) per GSF	\$ 144.81	\$ 153.90	\$ 160.17	\$ 160.54
Present Value Operations Expense (OPEX) per NSF	\$ 242.29	\$ 230.57	\$ 152.93	\$ 151.26
Ratio OPEX to CAPEX	1.67	1.50	0.95	0.94
Operation Cost Sensitivity	1.24	1.17	0.80	0.79

Definition: Ratio of annual operations costs to average of all options. Factor higher than 1 means present value will be affected by a change in annual (or energy) costs more than other options. Value below 1 means option will be less affected by a change.

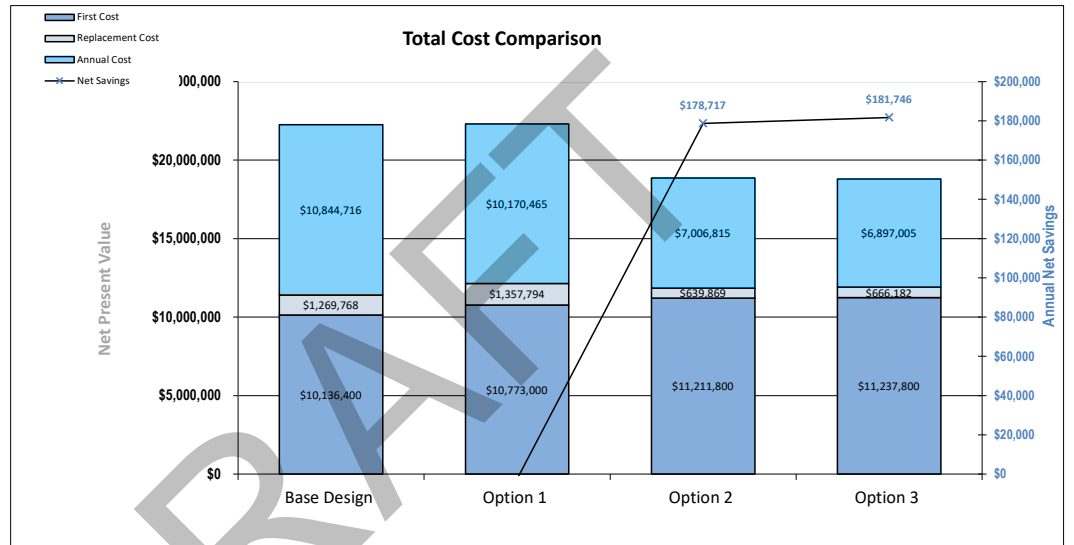

Summary and Recommendations:

Recommend the new Facility HVAC systems use Alternative 2 with a combination of decoupled + displacement ventilation with current central plant efficiency. Although it has a slightly higher installation cost, it has the lowest energy costs and life cycle costs.

DRAFT

REQUIRED TOOLS

T2

CATALOG OF COURTROOM LAYOUTS FOR CALIFORNIA TRIAL COURTS

SECTION	TOPIC	PAGE
T2.A	Courtroom Layout Overview	T2.2
T2.B	Multipurpose Courtroom Templates ..	T2.4
T2.C	Courtroom Design Examples	T2.29
T2.D	Holding Core Templates	T2.45



Central Courthouse, County of San Diego
San Diego, CA
Skidmore, Owings & Merrill LLP

T2.A COURTROOM LAYOUT OVERVIEW

MULTIPURPOSE COURTROOM TEMPLATES

GROUP 1—CENTER BENCH

TEMPLATE NAME	TOTAL SQUARE FEET*	SPECTATOR SEATING CAPACITY†	PAGE
Typical Trial Courtroom—Center Bench A	1,850	48	T2.4
Typical Large Trial Courtroom—Center Bench A	2,050	71	T2.6
Typical Trial Courtroom—Center Bench B	1,950	51	T2.8
Typical Large Trial Courtroom—Center Bench B	2,250	74	T2.10
Center Bench A with Holding Door Flipped	1,850	48	T2.12

Group 1 Courtrooms A use identical working areas, as do Courtrooms B. They vary from one another in that either a smaller gallery and two adjoining attorney-client conference rooms can be provided in the footprint or a larger gallery without the conference rooms can be selected.

GROUP 2—CORNER BENCH

TEMPLATE NAME	TOTAL SQUARE FEET*	SPECTATOR SEATING CAPACITY†	PAGE
Typical Trial Courtroom—Corner Bench A	1,796	48	T2.14
Typical Large Trial Courtroom—Corner Bench A	2,008	65	T2.16
Typical Trial Courtroom—Corner Bench B	2,056	48	T2.18
Typical Large Trial Courtroom—Corner Bench B	2,285	73	T2.20
Corner Bench A with Holding Door Flipped	1,796	48	T2.22

As with the center bench designs, Group 2 designs vary based on tradeoffs between more gallery space and adjoining conference rooms. Corner bench designs are used in a number of California courthouses, and although they compromise somewhat the efficient utilization of space in comparison with the center bench configuration, they are approved for use.

GROUP 3—CENTER BENCH, WIDE

TEMPLATE NAME	TOTAL SQUARE FEET*	SPECTATOR SEATING CAPACITY†	PAGE
Typical Large Trial Courtroom—Center Bench C	2,200	52	T2.24
Typical Large Trial Courtroom—Center Bench D	2,445	85	T2.26

These floorplans are significantly wider—but otherwise similar to the other center bench template designs—and can be considered when cases of unusual scale are routinely encountered in a specific jurisdiction.

REQUIRED TOOLS

T1 Life Cycle Cost Analysis

T2 CATALOG OF COURTROOM LAYOUTS FOR CALIFORNIA TRIAL COURTS

T2.A Courtroom Layout Overview

T2.B Multipurpose Courtroom Templates

T2.C Courtroom Design Examples

T2.D Holding Core Templates

T3 Integrated Network Architecture

T4 Graphical User Interface Template

T5 In-Custody Interview Room Guidelines

T6 Building Management System Guidelines

COURTROOM DESIGN EXAMPLES

COURTROOM EXAMPLE	TOTAL SQUARE FEET*	SPECTATOR SEATING CAPACITY†	PAGE
San Diego Central Courthouse, Trial Courtroom, Center Bench	1,700	46	T2.30
San Bernardino Justice Center, Trial Courtroom, Corner Bench	1,700	50	T2.32
San Diego Central Courthouse, Large Trial Courtroom, Center Bench	2,100	98	T2.34
San Diego Central Courthouse, Double Jury Courtroom, Center Bench	21,00	64	T2.36
San Bernardino Justice Center, Double Jury Courtroom, Corner Bench	2,400	92	T2.38
San Diego Central Courthouse, Arraignment Courtroom, Center Bench	1,800	98	T2.40
San Diego Central Courthouse, Family Courtroom, Center Bench	1,700	46	T2.42

HOLDING CORE TEMPLATES

	TOTAL SQUARE FEET*	TOTAL RATED CAPACITY	PAGE
Typical Holding Core—8" CMU Walls	709	7	T2.46
Typical Holding Core—6" CMU Walls	690	7	T2.47
Typical Holding Core—6" CMU Walls and 2" Metal Panel Walls at Holding	672	7	T2.48

* Includes ramp in corridor where applicable.

† Wheelchair spaces added to total spectator seating capacity.

T2.B MULTIPURPOSE COURTROOM TEMPLATES

Group 1—Center Bench Typical Trial Courtroom—Center Bench A *Courtroom Component Information*

COURTROOM TYPE	SQUARE FEET	SPECTATOR SEATING AT 18"	VOIR DIRE
Multipurpose Trial	1,850	46+2 WC	74

ELEMENT OR WORKSTATION	FURNITURE/ WIDTH	CASEWORK DEPTH	HEIGHT ABOVE FLOOR	NO. OF OCCUPANTS
Judge	6'6"/6'4"	2'0"/1'6"	+16"	1
Courtroom Clerk	12'0"	2'3"	+12"	2
Court Security Officer (CSO)	4'0"	2'6"	+0"	1
Court Reporter	4'0"	2'0"	+0"	1
Witness Stand	5'0"	1'7"	+6"	2
Jury Box	N/A	N/A	(1st row) +0" (2nd row) +6"	14
Counsel Tables	7'0"	3'0"	+0"	3 ea.
DEPS Cart	2'0"	2'0"	N/A	0
Lectern	2'6"	2'0"	N/A	0

WC = wheelchairs.

DEPS = Digital Evidence Presentation System.

Key Attributes of Courtroom Layout

- Seventy-four seats for voir dire to provide maximum flexibility for trial use.
- Increase of judge's bench work surface from 6' to 12'10" long.
- Increase of work surface return at judge's bench from 10" to 18" deep.
- Access ramps outside courtroom.
- Judge's bench elevated 16" to minimize need for ramping.
- Optimal sightlines for all participants.
- Multidefendant capable because of movable well components.
- Multiple locations for sidebar conferences (indicated with * on schematic, next page).
- Exhibit storage table adjacent to clerk's workstation.
- Stairs to clerk's workstation area, which reduce width of courtroom.
- Jury box dimensions are efficient and control courtroom width.
- Adjustable-height work surfaces for judge and clerk.

Options provided:

- Alternative court security officer desk and evidence table locations.
- Movable lectern and court reporter's station that facilitate options for adding counsel tables.

Note:

- A court may adjust the combined ramp pitches from floor level to the bench to retain the bench height of 16" while lowering the clerk floor height, so long as the maximum pitch utilized does not exceed a 1:12 ratio.

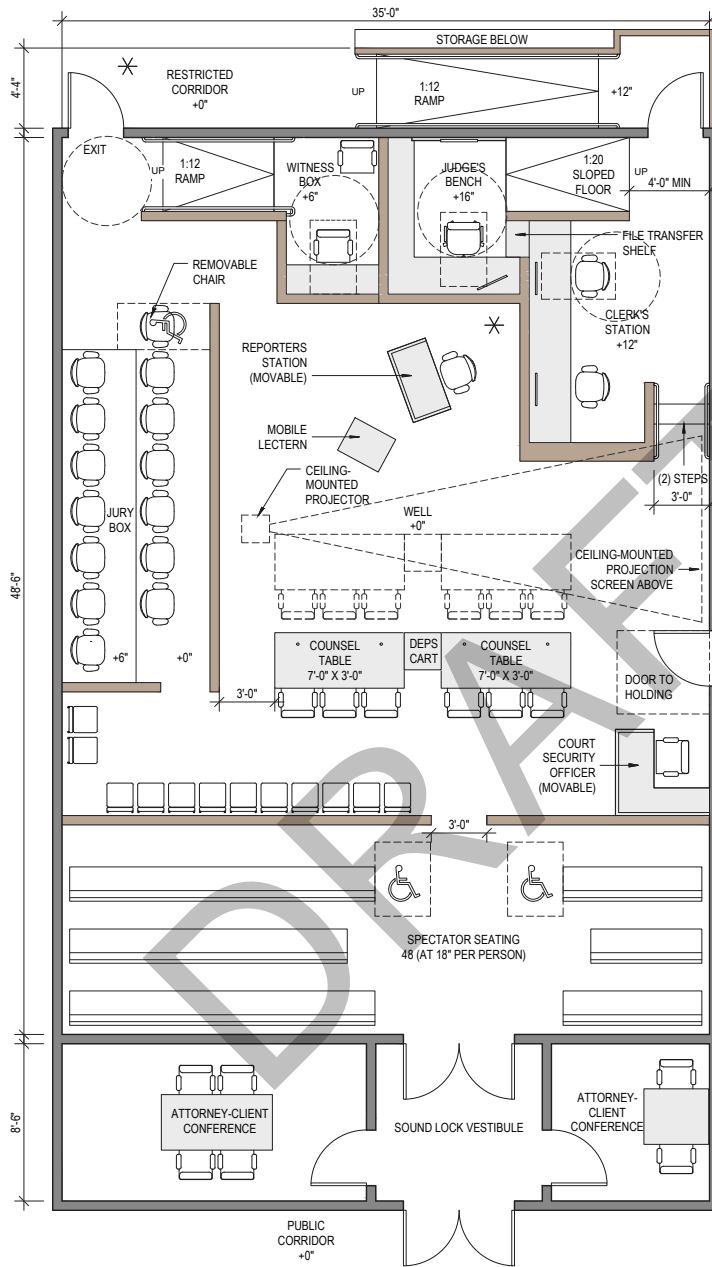

REQUIRED TOOLS

T1 Life Cycle Cost Analysis

T2 CATALOG OF COURTROOM LAYOUTS FOR CALIFORNIA TRIAL COURTS

T2.A Courtroom Layout Overview

T2.B Multipurpose Courtroom Templates

T2.C Courtroom Design Examples

T2.D Holding Core Templates

T3 Integrated Network Architecture

T4 Graphical User Interface Template

T5 In-Custody Interview Room Guidelines

T6 Building Management System Guidelines

Figure T2.1 Typical Trial Courtroom—Center Bench A

Typical Large Trial Courtroom—Center Bench A
Courtroom Component Information

COURTROOM TYPE	SQUARE FEET	SPECTATOR SEATING (18")	VOIR DIRE
Multipurpose Large Trial	2,050	67+4 WC	97

ELEMENT OR WORKSTATION	FURNITURE/ WIDTH	CASEWORK DEPTH	HEIGHT ABOVE FLOOR	NO. OF OCCUPANTS
Judge	6'6"/6'4"	2'0"/1'6"	+16"	1
Courtroom Clerk	12'0"	2'3"	+12"	2
Court Security Officer	4'0"	2'6"	+0"	1
Court Reporter	4'0"	2'0"	+0"	1
Witness Stand	5'0"	1'7"	+6"	2
Jury Box	N/A	N/A	(1st row) +0" (2nd row) +6"	14
Counsel Tables	7'0"	3'0"	+0"	3 ea.
DEPS Cart	2'0"	2'0"	N/A	0
Lectern	2'6"	2'0"	N/A	0

Key Attributes of Courtroom Layout

- Ninety-seven seats for voir dire to provide maximum flexibility for trial use.
- Multidefendant capable.
- Increase of judge’s bench work surface from 6’ to 12’10” long.
- Increase of work surface return at judge’s bench from 10” to 18” deep.
- Judge’s bench elevated 16” to minimize need for ramping.
- Multiple locations for sidebar conferences (indicated with * on schematic, next page).
- Optimal sightlines for all participants.
- Exhibit storage table adjacent to clerk’s workstation.
- Adjustable-height work surfaces for judge and clerk.
- Increase of clerk’s work surface from 10’ to 12’ long (two clerks).
- Jury box dimensions that are efficient and control courtroom width.
- Spectator seating increased by eliminating attorney-client conference rooms.

Options provided:

- Alternative court security officer desk and evidence table locations.
- Movable lectern and court reporter’s station that facilitate options for adding counsel tables.

Note:

- A court may adjust the combined ramp pitches from floor level to the bench to retain the bench height of 16” while lowering the clerk floor height, so long as the maximum pitch utilized does not exceed a 1:12 ratio.

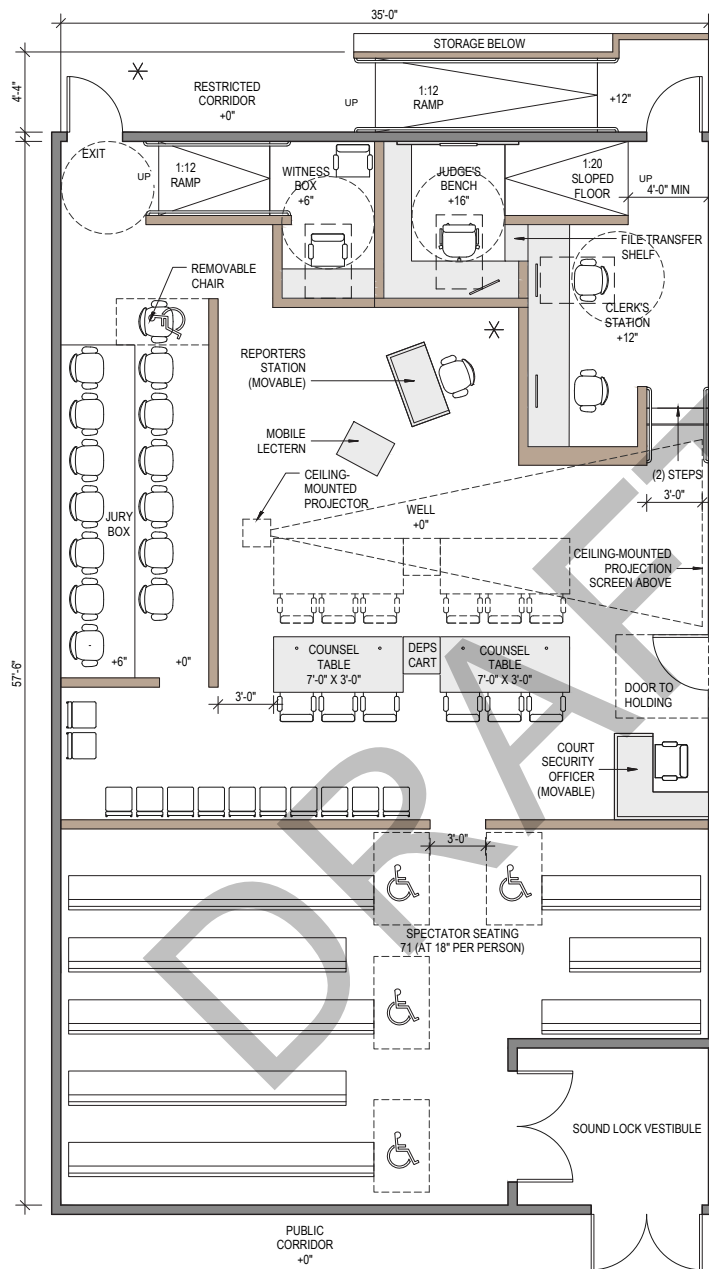

REQUIRED TOOLS

T1 Life Cycle Cost Analysis

T2 CATALOG OF COURTROOM LAYOUTS FOR CALIFORNIA TRIAL COURTS

T2.A Courtroom Layout Overview

T2.B Multipurpose Courtroom Templates

T2.C Courtroom Design Examples

T2.D Holding Core Templates

T3 Integrated Network Architecture

T4 Graphical User Interface Template

T5 In-Custody Interview Room Guidelines

T6 Building Management System Guidelines

Figure T2.2 Typical Large Trial Courtroom—Center Bench A

Typical Trial Courtroom—Center Bench B
Courtroom Component Information

COURTROOM TYPE	SQUARE FEET	SPECTATOR SEATING (18")	VOIR DIRE
Multipurpose Trial	1,950	49+2 WC	77

ELEMENT OR WORKSTATION	FURNITURE/ WIDTH	CASEWORK DEPTH	HEIGHT ABOVE FLOOR	NO. OF OCCUPANTS
Judge	7'9"/6'4"	2'0"/1'6"	+16"	1
Courtroom Clerk	12'0"	2'3"	+12"	2
Court Security Officer	4'0"	2'6"	+0"	1
Court Reporter	4'0"	2'0"	+0"	1
Witness Stand	5'6"	1'7"	+6"	2
Jury Box	N/A	N/A	(1st row) +0" (2nd row) +6"	14
Counsel Tables	7'6"	3'0"	+0"	3 ea.
DEPS Cart	2'0"	2'0"	N/A	0
Lectern	2'6"	2'0"	N/A	0

Key Attributes of Courtroom Layout

- Seventy-four seats for voir dire to provide maximum flexibility for trial use.
- Multidefendant capable because of movable well components and increased courtroom width.
- Increase of judge’s bench work surface from 6’ to 14’1” long.
- Increase of work surface return at judge’s bench from 10” to 18” deep.
- Judge’s bench elevated 16” to minimize need for ramping.*
- Multiple locations for sidebar conferences (indicated with on schematic, next page).
- Optimal sightlines for all participants.
- Exhibit storage table adjacent to clerk’s workstation.
- Increase of clerk’s work surface from 10’ to 12’ long (two clerks).
- Stairs to clerk’s workstation area, which reduce width of courtroom.
- Adjustable-height work surfaces for judge and clerk.
- Counsel tables providing for four seats at each table.
- Jury box dimensions that are efficient and control courtroom width.

Options provided:

- Alternative court security officer desk and evidence table locations.
- Movable lectern and court reporter’s station facilitate options for adding counsel tables.

Note:

- A court may adjust the combined ramp pitches from floor level to the bench to retain the bench height of 16” while lowering the clerk floor height, so long as the maximum pitch utilized does not exceed a 1:12 ratio.

REQUIRED TOOLS

T1 Life Cycle Cost Analysis

T2 CATALOG OF COURTROOM LAYOUTS FOR CALIFORNIA TRIAL COURTS

T2.A Courtroom Layout Overview

T2.B Multipurpose Courtroom Templates

T2.C Courtroom Design Examples

T2.D Holding Core Templates

T3 Integrated Network Architecture

T4 Graphical User Interface Template

T5 In-Custody Interview Room Guidelines

T6 Building Management System Guidelines

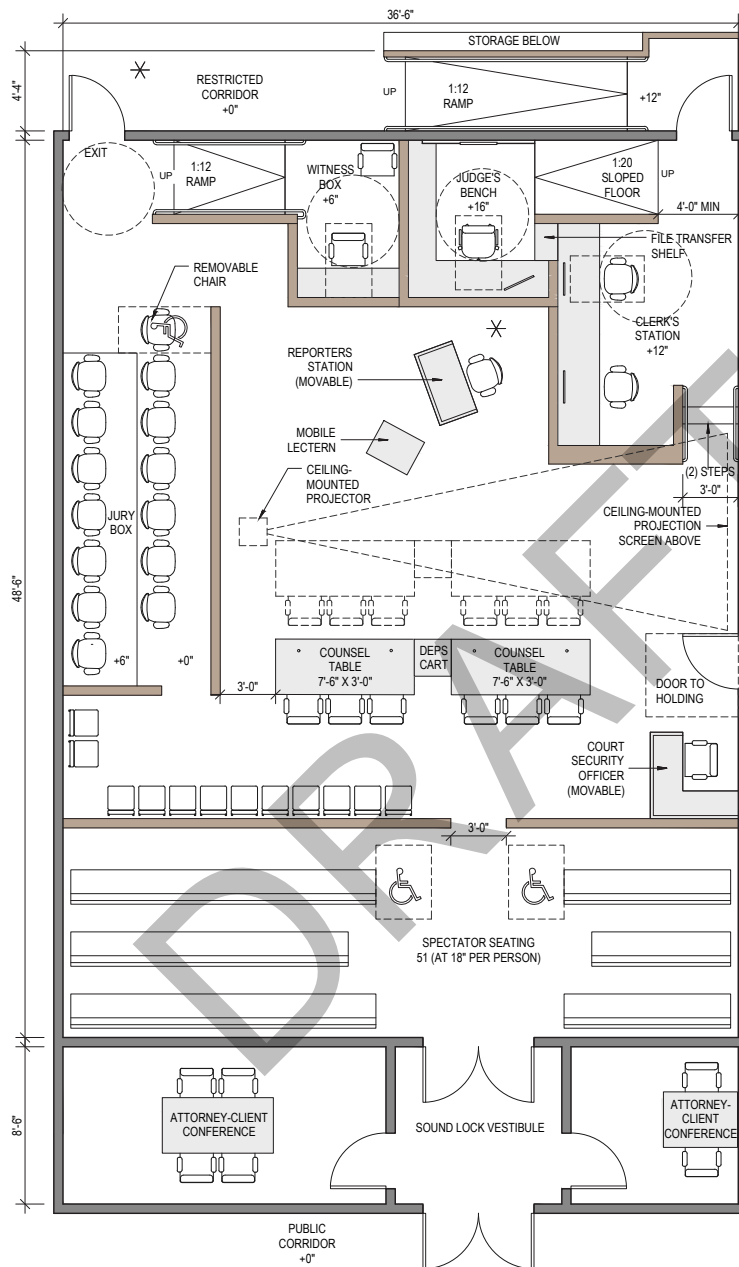

Figure T2.3 Typical Trial Courtroom—Center Bench B

Typical Large Trial Courtroom—Center Bench B
Courtroom Component Information

COURTROOM TYPE	SQUARE FEET	SPECTATOR SEATING (18")	VOIR DIRE
Multipurpose Large Trial	2,250	70+4 WC	100

ELEMENT OR WORKSTATION	FURNITURE/ WIDTH	CASEWORK DEPTH	HEIGHT ABOVE FLOOR	NO. OF OCCUPANTS
Judge	7'9"/6'4"	2'0"/1'6"	+16"	1
Courtroom Clerk	12'0"	2'3"	+12"	2
Court Security Officer	4'0"	2'6"	+0"	1
Court Reporter	4'0"	2'0"	+0"	1
Witness Stand	5'6"	1'7"	+6"	2
Jury Box	N/A	N/A	(1st row) +0" (2nd row) +6"	14
Counsel Tables	7'6"	3'0"	+0"	3 ea.
DEPS Cart	2'0"	2'0"	N/A	0
Lectern	2'6"	2'0"	N/A	0

Key Attributes of Courtroom Layout

- One hundred seats for voir dire to provide maximum flexibility for trial use.
- Multidefendant capable because of movable well components and increased courtroom width.
- Increase of judge’s bench work surface from 6’ to 14’1” long.
- Increase of work surface return at judge’s bench from 10” to 18” deep.
- Judge’s bench elevated 16” to minimize need for ramping.
- Multiple locations for sidebar conferences (indicated with * on schematic, next page).
- Optimal sightlines for all participants.
- Exhibit storage table adjacent to clerk’s workstation.
- Adjustable-height work surfaces for judge and clerk.
- Increase of clerk’s work surface from 10’ to 12’ long (two clerks).
- Clerk’s storage in workstation area.
- Ramp provided to clerk’s workstation area.
- Counsel tables to provide for four seats at each table.
- Jury box dimensions that are efficient and control courtroom width.
- Spectator seating increased by eliminating attorney-client conference rooms.

Options provided:

- Alternative court security officer desk and evidence table locations.
- Movable lectern and court reporter’s station that facilitate options for adding counsel tables.

Note:

- A court may adjust the combined ramp pitches from floor level to the bench to retain the bench height of 16” while lowering the clerk floor height, so long as the maximum pitch utilized does not exceed a 1:12 ratio.

REQUIRED TOOLS

T1 Life Cycle Cost Analysis

- T2 CATALOG OF COURTROOM LAYOUTS FOR CALIFORNIA TRIAL COURTS**
- T2.A Courtroom Layout Overview
- T2.B Multipurpose Courtroom Templates
- T2.C Courtroom Design Examples
- T2.D Holding Core Templates

- T3 Integrated Network Architecture
- T4 Graphical User Interface Template
- T5 In-Custody Interview Room Guidelines
- T6 Building Management System Guidelines

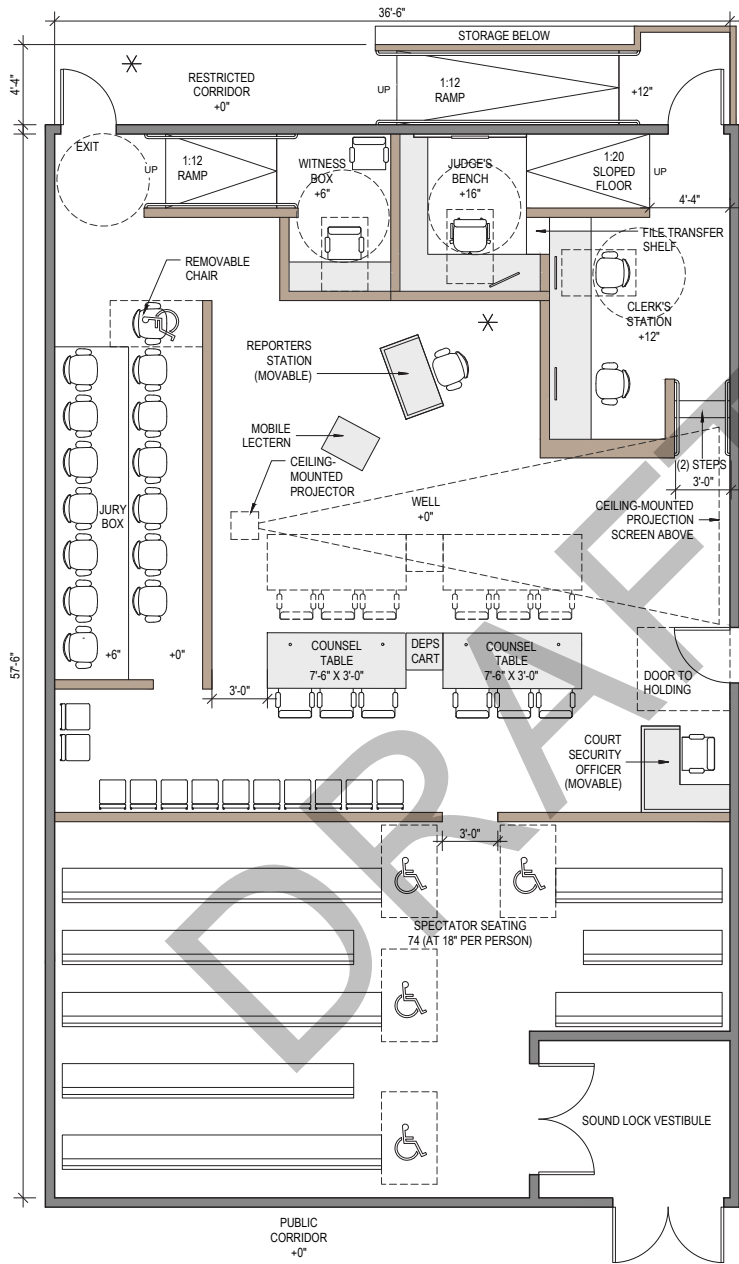

Figure T2.4 Typical Large Trial Courtroom—Center Bench B

Center Bench A with Holding Door Flipped

Courtroom Component Information

COURTROOM TYPE	SQUARE FEET	SPECTATOR SEATING AT 18"	VOIR DIRE
Multipurpose Trial	1,850	46+2 WC	72

ELEMENT OR WORKSTATION	FURNITURE/ WIDTH	CASEWORK DEPTH	HEIGHT ABOVE FLOOR	NO. OF OCCUPANTS
Judge	6'6"/6'4"	2'0"/1'6"	+16"	1
Courtroom Clerk	12'0"	2'3"	+12"	2
Court Security Officer (CSO)	4'0"	2'6"	+0"	1
Court Reporter	4'0"	2'0"	+0"	1
Witness Stand	5'0"	1'7"	+6"	2
Jury Box	N/A	N/A	(1st row) +0" (2nd row) +6"	14
Counsel Tables	7'0"	3'0"	+0"	3 ea.
DEPS Cart	2'0"	2'0"	N/A	0
Lectern	2'6"	2'0"	N/A	0

Key Attributes of Courtroom Layout

- Seventy-two seats for voir dire to provide maximum flexibility for trial use.
- Increase of judge's bench work surface from 6' to 12'10" long.
- Increase of work surface return at judge's bench from 10" to 18" deep.
- Access ramps outside courtroom.
- Judge's bench elevated 16" to minimize need for ramping.
- Optimal sightlines for all participants.
- Multidefendant capable because of movable well components.
- Multiple locations for sidebar conferences (indicated with * on schematic, next page).
- Exhibit storage table adjacent to clerk's workstation.
- Stairs to clerk's workstation area, which reduce width of courtroom.
- Jury box dimensions are efficient and control courtroom width.
- Adjustable-height work surfaces for judge and clerk.

Options provided:

- Alternative court security officer desk and evidence table locations.
- Movable lectern and court reporter's station that facilitate options for adding counsel tables.

Note:

- A court may adjust the combined ramp pitches from floor level to the bench to retain the bench height of 16" while lowering the clerk floor height, so long as the maximum pitch utilized does not exceed a 1:12 ratio.

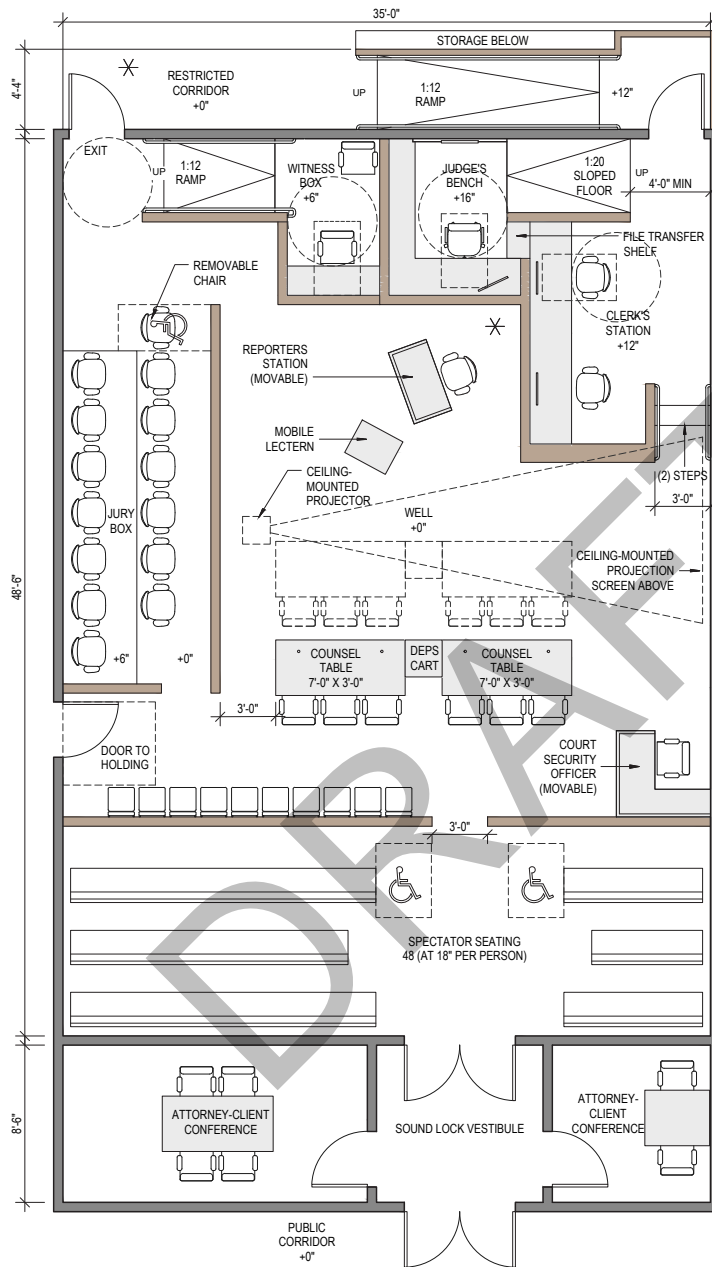

REQUIRED TOOLS

T1 Life Cycle Cost Analysis

T2 CATALOG OF COURTROOM LAYOUTS FOR CALIFORNIA TRIAL COURTS

T2.A Courtroom Layout Overview

T2.B Multipurpose Courtroom Templates

T2.C Courtroom Design Examples

T2.D Holding Core Templates

T3 Integrated Network Architecture

T4 Graphical User Interface Template

T5 In-Custody Interview Room Guidelines

T6 Building Management System Guidelines

Figure T2.5 Center Bench A with Holding Door Flipped

Group 2—Corner Bench
Typical Trial Courtroom—Corner Bench A
Courtroom Component Information

COURTROOM TYPE	TOTAL SQUARE FEET (INCLUDES RAMP IN CORRIDOR)	SPECTATOR SEATING AT 18"	VOIR DIRE
Typical Trial	1,796	46+2 WC	72

ELEMENT OR WORKSTATION	FURNITURE/ WIDTH	CASEWORK DEPTH	HEIGHT ABOVE FLOOR	NO. OF OCCUPANTS
Judge	6'6"/6'9"	2'0"/1'6"	+16"	1
Courtroom Clerk	9'3"	2'3"	+12"	2
Court Security Officer	4'6"	2'0"	+0"	1
Court Reporter	4'0"	2'0"	+0"	1
Witness Stand	6'0"	1'7"	+6"	2
Jury Box	N/A	N/A	(1st row) +0" (2nd row) +6"	14
Counsel Tables	7'0"	3'0"	+0"	3 ea.
DEPS Cart	2'0"	2'0"	N/A	0
Lectern	2'6"	2'0"	N/A	0

Key Attributes of Courtroom Layout

- Seventy-two seats for voir dire to provide maximum flexibility for trial use.
- Increase of judge’s bench work surface from 6’ to 13’3” long.
- Increase of work surface return at judge’s bench from 10” to 18” deep.
- Judge’s bench elevated 16” to minimize need for ramping.
- Multiple locations for sidebar conferences (indicated with * on schematic, next page).
- Optimal sightlines for all participants.
- Exhibit storage table adjacent to clerk’s workstation.
- Stairs to clerk’s workstation area, which reduce width of courtroom.
- Adjustable-height work surfaces for judge and clerk.
- Jury box dimensions that are efficient and control courtroom width.

Note:

- A court may adjust the combined ramp pitches from floor level to the bench to retain the bench height of 16” while lowering the clerk floor height, so long as the maximum pitch utilized does not exceed a 1:12 ratio.

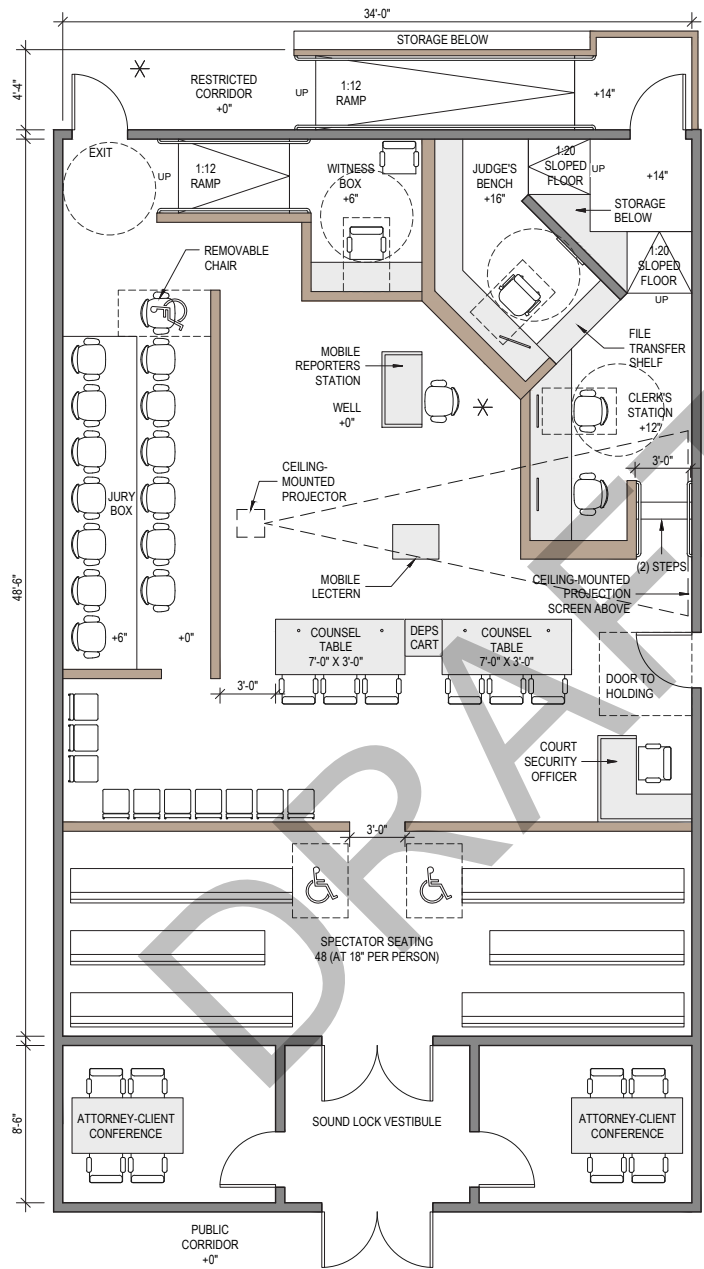

REQUIRED TOOLS

T1 Life Cycle Cost Analysis

T2 CATALOG OF COURTROOM LAYOUTS FOR CALIFORNIA TRIAL COURTS

T2.A Courtroom Layout Overview

T2.B Multipurpose Courtroom Templates

T2.C Courtroom Design Examples

T2.D Holding Core Templates

T3 Integrated Network Architecture

T4 Graphical User Interface Template

T5 In-Custody Interview Room Guidelines

T6 Building Management System Guidelines

Figure T2.6 Typical Trial Courtroom—Corner Bench A

Typical Large Trial Courtroom—Corner Bench A

Courtroom Component Information

COURTROOM TYPE	SQUARE FEET	SPECTATOR SEATING (18")	VOIR DIRE
Multipurpose Large Trial	2,008	61+4 WC	90

ELEMENT OR WORKSTATION	FURNITURE/ WIDTH	CASEWORK DEPTH	HEIGHT ABOVE FLOOR	NO. OF OCCUPANTS
Judge	6'6"/6'9"	2'0"/1'6"	+16"	1
Courtroom Clerk	9'3"	2'3"	+12"	2
Court Security Officer	4'0"	2'0"	+0"	1
Court Reporter	4'0"	2'0"	+0"	1
Witness Stand	5'6"	1'7"	+6"	2
Jury Box	N/A	N/A	(1st row) +0" (2nd row) +6"	14
Counsel Tables	7'0"	3'0"	+0"	3 ea.
DEPS Cart	2'0"	2'0"	N/A	0
Lectern	2'6"	2'0"	N/A	0

Key Attributes of Courtroom Layout

- Ninety seats for voir dire to provide maximum flexibility for trial use.
- Increase of judge's bench work surface from 6' to 13'3" long.
- Increase of work surface return at judge's bench from 10" to 18" deep.
- Judge's bench elevated 16" to minimize need for ramping.
- Multiple locations for sidebar conferences (indicated with * on schematic, next page).
- Optimal sightlines for all participants.
- Exhibit storage table adjacent to clerk's workstation.
- Adjustable-height work surfaces for judge and clerk.
- Jury box dimensions that are efficient and control courtroom width.
- Spectator seating increased by eliminating attorney-client conference rooms.

Note:

- A court may adjust the combined ramp pitches from floor level to the bench to retain the bench height of 16" while lowering the clerk floor height, so long as the maximum pitch utilized does not exceed a 1:12 ratio.

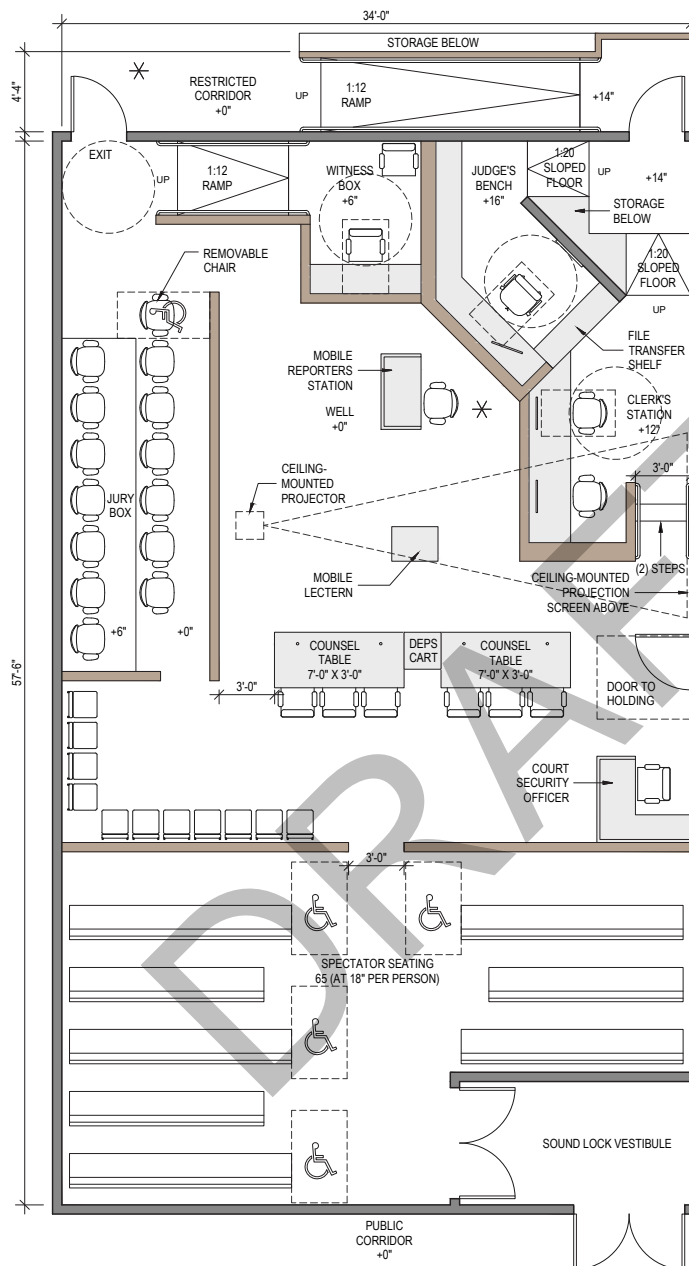

REQUIRED TOOLS

T1 Life Cycle Cost Analysis

T2 CATALOG OF COURTROOM LAYOUTS FOR CALIFORNIA TRIAL COURTS

T2.A Courtroom Layout Overview

T2.B Multipurpose Courtroom Templates

T2.C Courtroom Design Examples

T2.D Holding Core Templates

T3 Integrated Network Architecture

T4 Graphical User Interface Template

T5 In-Custody Interview Room Guidelines

T6 Building Management System Guidelines

Figure T2.7 Typical Large Trial Courtroom—Corner Bench A

Typical Trial Courtroom—Corner Bench B

Courtroom Component Information

COURTROOM TYPE	TOTAL SQUARE FEET (INCLUDES RAMP IN CORRIDOR)	SPECTATOR SEATING AT 18"	VOIR DIRE
Typical Trial	2,056	46+2 WC	73

ELEMENT OR WORKSTATION	FURNITURE/ WIDTH	CASEWORK DEPTH	HEIGHT ABOVE FLOOR	NO. OF OCCUPANTS
Judge	8'0"/6'9"	2'0"/1'6"	+16"	1
Courtroom Clerk	9'3"	2'3"	+12"	2
Court Security Officer	4'6"	2'0"	+0"	1
Court Reporter	4'0"	2'0"	+0"	1
Witness Stand	6'0"	1'7"	+6"	2
Jury Box	N/A	N/A	(1st row) +0" (2nd row) +6"	14
Counsel Tables	7'6"	3'0"	+0"	3 ea.
DEPS Cart	2'0"	2'0"	N/A	0
Lectern	2'6"	2'0"	N/A	0

Key Attributes of Courtroom Layout

- Seventy-three seats for voir dire to provide maximum flexibility for trial use.
- Increase of judge's bench work surface from 6' to 14'9" long.
- Increase of work surface return at judge's bench from 10" to 18" deep.
- Judge's bench elevated 16" to minimize need for ramping.
- Multiple locations for sidebar conferences (indicated with * on schematic, next page).
- Optimal sightlines for all participants.
- Multidefendant capable because of movable well components.
- Exhibit storage table adjacent to clerk's workstation.
- Stairs to clerk's workstation area, which reduce width of courtroom.
- Adjustable-height work surfaces for judge and clerk.
- Jury box dimensions that are efficient and control courtroom width.

Note:

- A court may adjust the combined ramp pitches from floor level to the bench to retain the bench height of 16" while lowering the clerk floor height, so long as the maximum pitch utilized does not exceed a 1:12 ratio.

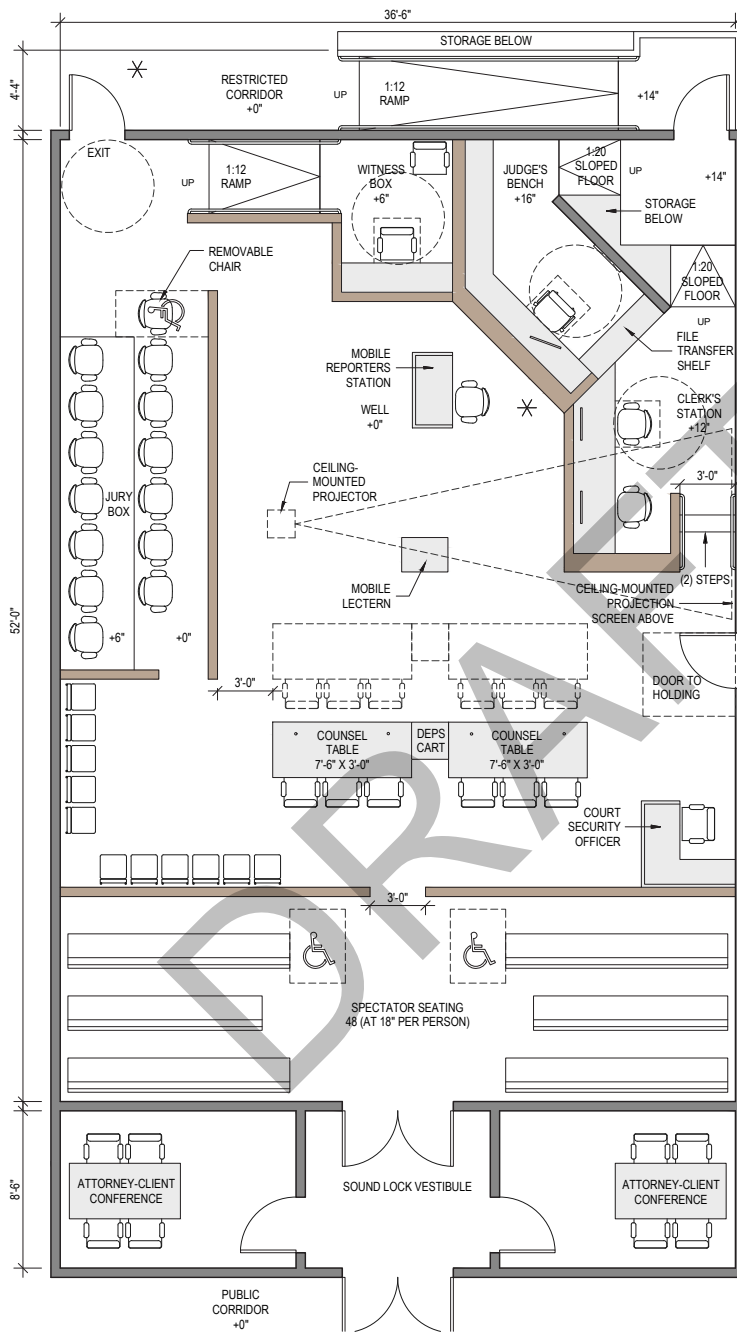

REQUIRED TOOLS

T1 Life Cycle Cost Analysis

T2 CATALOG OF COURTROOM LAYOUTS FOR CALIFORNIA TRIAL COURTS

T2.A Courtroom Layout Overview

T2.B Multipurpose Courtroom Templates

T2.C Courtroom Design Examples

T2.D Holding Core Templates

T3 Integrated Network Architecture

T4 Graphical User Interface Template

T5 In-Custody Interview Room Guidelines

T6 Building Management System Guidelines

Figure T2.8 Typical Trial Courtroom—Corner Bench B

Typical Large Trial Courtroom—Corner Bench B
Courtroom Component Information

COURTROOM TYPE	SQUARE FEET	SPECTATOR SEATING (18")	VOIR DIRE
Multipurpose Large Trial	2,285	69+4 WC	100

ELEMENT OR WORKSTATION	FURNITURE/ WIDTH	CASEWORK DEPTH	HEIGHT ABOVE FLOOR	NO. OF OCCUPANTS
Judge	8'0"/6'9"	2'0"/1'6"	+16"	1
Courtroom Clerk	9'3"	2'3"	+12"	2
Court Security Officer	4'0"	2'0"	+0"	1
Court Reporter	4'0"	2'0"	+0"	1
Witness Stand	5'6"	1'7"	+6"	2
Jury Box	N/A	N/A	(1st row) +0" (2nd row) +6"	14
Counsel Tables	7'6"	3'0"	+0"	3 ea.
DEPS Cart	2'0"	2'0"	N/A	0
Lectern	2'6"	2'0"	N/A	0

Key Attributes of Courtroom Layout

- One hundred seats for voir dire to provide maximum flexibility for trial use.
- Multidefendant capable.
- Increase of judge’s bench work surface from 6’ to 14’9” long.
- Increase of work surface return at judge’s bench from 10” to 18” deep.
- Judge’s bench elevated 16” to minimize need for ramping.
- Multiple locations for sidebar conferences (indicated with * on schematic, next page).
- Optimal sightlines for all participants.
- Exhibit storage table adjacent to clerk’s workstation.
- Adjustable-height work surfaces for judge and clerk.
- Jury box dimensions that are efficient and control courtroom width.
- Additional counsel tables accommodated by eliminating attorney-client conference rooms.

Note:

- A court may adjust the combined ramp pitches from floor level to the bench to retain the bench height of 16” while lowering the clerk floor height, so long as the maximum pitch utilized does not exceed a 1:12 ratio.

Corner Bench A with Holding Door Flipped
Courtroom Component Information

COURTROOM TYPE	TOTAL SQUARE FEET (INCLUDES RAMP IN CORRIDOR)	SPECTATOR SEATING AT 18"	VOIR DIRE
Typical Trial	1,796	46+2 WC	69

ELEMENT OR WORKSTATION	FURNITURE/ WIDTH	CASEWORK DEPTH	HEIGHT ABOVE FLOOR	NO. OF OCCUPANTS
Judge	6'6"/6'9"	2'0"/1'6"	+16"	1
Courtroom Clerk	9'3"	2'3"	+12"	2
Court Security Officer	4'6"	2'0"	+0"	1
Court Reporter	4'0"	2'0"	+0"	1
Witness Stand	6'0"	1'7"	+6"	2
Jury Box	N/A	N/A	(1st row) +0" (2nd row) +6"	14
Counsel Tables	7'0"	3'0"	+0"	3 ea.
DEPS Cart	2'0"	2'0"	N/A	0
Lectern	2'6"	2'0"	N/A	0

Key Attributes of Courtroom Layout

- Sixty-nine seats for voir dire to provide maximum flexibility for trial use.
- Increase of judge's bench work surface from 6' to 13'3" long.
- Increase of work surface return at judge's bench from 10" to 18" deep.
- Judge's bench elevated 16" to minimize need for ramping.
- Multiple locations for sidebar conferences (indicated with * on schematic, next page).
- Optimal sightlines for all participants.
- Exhibit storage table adjacent to clerk's workstation.
- Stairs to clerk's workstation area, which reduce width of courtroom.
- Adjustable-height work surfaces for judge and clerk.
- Jury box dimensions that are efficient and control courtroom width.

Note:

- A court may adjust the combined ramp pitches from floor level to the bench to retain the bench height of 16" while lowering the clerk floor height, so long as the maximum pitch utilized does not exceed a 1:12 ratio.

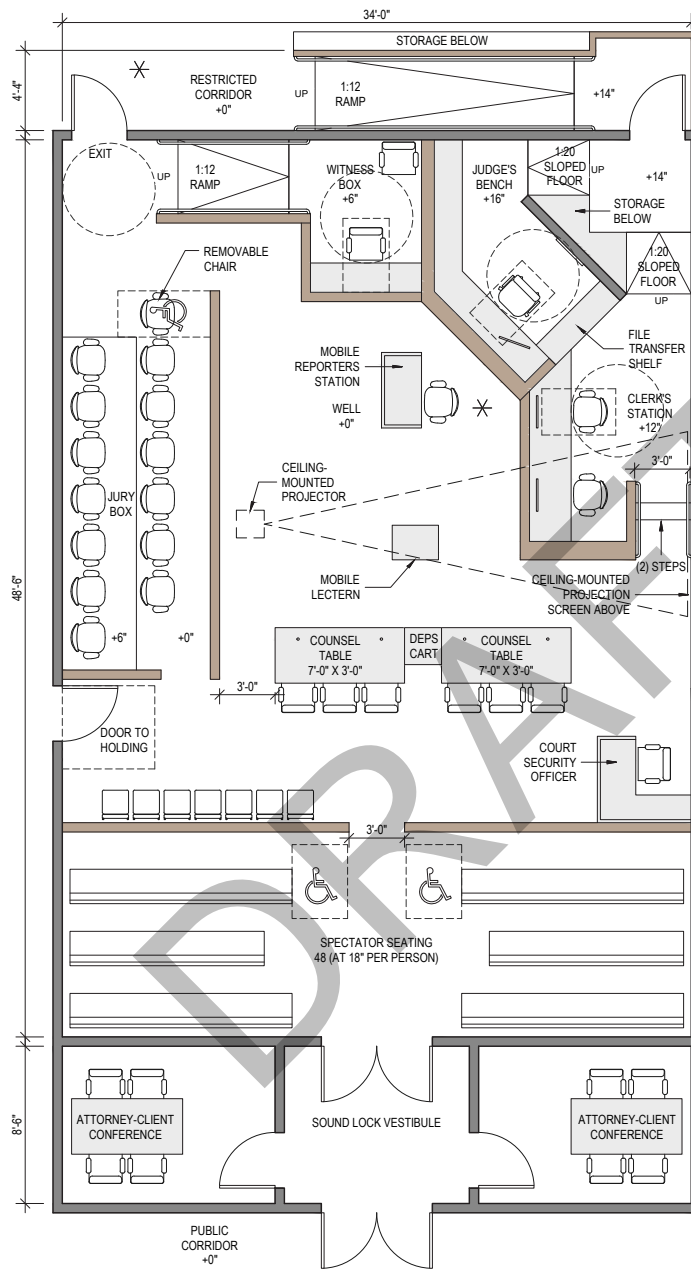

REQUIRED TOOLS

T1 Life Cycle Cost Analysis

T2 CATALOG OF COURTROOM LAYOUTS FOR CALIFORNIA TRIAL COURTS

T2.A Courtroom Layout Overview

T2.B Multipurpose Courtroom Templates

T2.C Courtroom Design Examples

T2.D Holding Core Templates

T3 Integrated Network Architecture

T4 Graphical User Interface Template

T5 In-Custody Interview Room Guidelines

T6 Building Management System Guidelines

Figure T2.10 Corner Bench A with Holding Door Flipped

Group 3—Center Bench, Wide
Typical Large Trial Courtroom—Center Bench C
Courtroom Component Information

COURTROOM TYPE	SQUARE FEET	SPECTATOR SEATING (18")	VOIR DIRE
Multipurpose Large Trial	2,200	50+2 WC	78

ELEMENT OR WORKSTATION	FURNITURE/ WIDTH	CASEWORK DEPTH	HEIGHT ABOVE FLOOR	NO. OF OCCUPANTS
Judge	7'9"/6'10"	2'0"/1'6"	+16"	1
Courtroom Clerk	12'0"	2'3"	+10"	2
Court Security Officer	4'0"	2'6"	+0"	1
Court Reporter	4'0"	2'0"	+0"	1
Witness Stand	5'6"	1'7"	+6"	2
Jury Box	N/A	N/A	(1st row) +0" (2nd row) +6"	14
Counsel Tables	8'6"	3'0"	+0"	4 ea.
DEPS Cart	2'0"	2'0"	N/A	0
Lectern	2'6"	2'0"	N/A	0

Key Attributes of Courtroom Layout

- Seventy-eight seats for voir dire to provide maximum flexibility for trial use.
- Multidefendant capable because of movable well components and increased courtroom width.
- Increase of judge’s bench work surface from 6’ to 14’7” long.
- Increase of work surface return at judge’s bench from 10” to 18” deep.
- Judge’s bench elevated 16” to minimize need for ramping.
- Multiple locations for sidebar conferences (indicated with * on schematic, next page).
- Optimal sightlines for all participants.
- Exhibit storage table adjacent to clerk’s workstation.
- Adjustable-height work surfaces for judge and clerk.
- Clerk’s work surface increased from 10’ to 12’ long (two clerks).
- Clerk’s storage in workstation area.
- Ramp provided to clerk’s workstation area.
- Counsel tables providing for four seats at each table.
- Jury box that provides increased room to accommodate individual flat screen displays, room for jurors when exiting, and two alternative locations for wheelchair locations.

Options provided:

- Alternative court security officer desk and evidence table locations.
- Movable lectern and court reporter’s station that facilitate options for adding counsel tables.

Note:

- A court may adjust the combined ramp pitches from floor level to the bench to retain the bench height of 16” while lowering the clerk floor height, so long as the maximum pitch utilized does not exceed a 1:12 ratio.

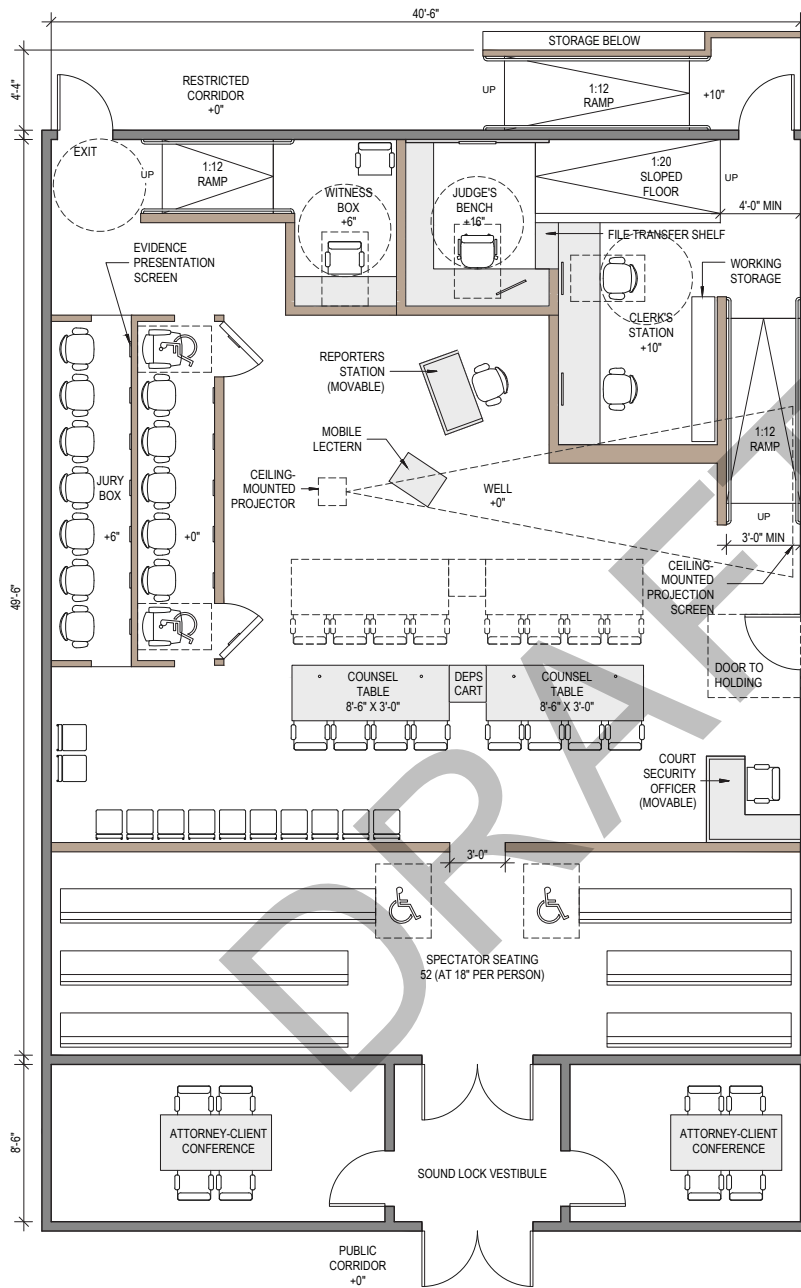

REQUIRED TOOLS

T1 Life Cycle Cost Analysis

T2 CATALOG OF COURTROOM LAYOUTS FOR CALIFORNIA TRIAL COURTS

T2.A Courtroom Layout Overview

T2.B Multipurpose Courtroom Templates

T2.C Courtroom Design Examples

T2.D Holding Core Templates

T3 Integrated Network Architecture

T4 Graphical User Interface Template

T5 In-Custody Interview Room Guidelines

T6 Building Management System Guidelines

Figure T2.11 Typical Large Trial Courtroom—Center Bench C

Typical Large Trial Courtroom—Center Bench D
Courtroom Component Information

COURTROOM TYPE	SQUARE FEET	SPECTATOR SEATING (18")	VOIR DIRE
Multipurpose Large Trial	2,445	81+4 WC	110

ELEMENT OR WORKSTATION	FURNITURE/ WIDTH	CASEWORK DEPTH	HEIGHT ABOVE FLOOR	NO. OF OCCUPANTS
Judge	7'9"/6'10"	2'0"/1'6"	+16"	1
Courtroom Clerk	12'0"	2'3"	+10"	2
Court Security Officer	4'0"	2'6"	+0"	1
Court Reporter	4'0"	2'0"	+0"	1
Witness Stand	5'6"	1'7"	+6"	2
Jury Box	N/A	N/A	(1st row) +0" (2nd row) +6"	14
Counsel Tables	8'6"	3'0"	+0"	4 ea.
DEPS Cart	2'0"	2'0"	N/A	0
Lectern	2'6"	2'0"	N/A	0

Key Attributes of Courtroom Layout

- One hundred ten seats for voir dire to provide maximum flexibility for trial use.
- Multidefendant capable because of movable well components and increased courtroom width.
- Increase of judge’s bench work surface from 6’ to 14’7” long.
- Increase of work surface return at judge’s bench from 10” to 18” deep.
- Judge’s bench elevated 16” to minimize need for ramping.
- Multiple locations for sidebar conferences (indicated with * on schematic, next page).
- Optimal sightlines for all participants.
- Exhibit storage table adjacent to clerk’s workstation.
- Adjustable-height work surfaces for judge and clerk.
- Clerk’s work surface increased from 10’ to 12’ long (two clerks).
- Clerk’s storage in workstation area.
- Ramp provided to clerk’s workstation area.
- Counsel tables providing for four seats at each table.
- Jury box that provides increased room to accommodate individual flat screen displays, room for jurors when exiting, and two alternative locations for wheelchair locations.
- Spectator seating increased by eliminating attorney-client conference rooms.

Options provided:

- Alternative court security officer desk and evidence table locations.
- Movable lectern and court reporter’s station that facilitate options for adding counsel tables.

Note:

- A court may adjust the combined ramp pitches from floor level to the bench to retain the bench height of 16” while lowering the clerk floor height, so long as the maximum pitch utilized does not exceed a 1:12 ratio.

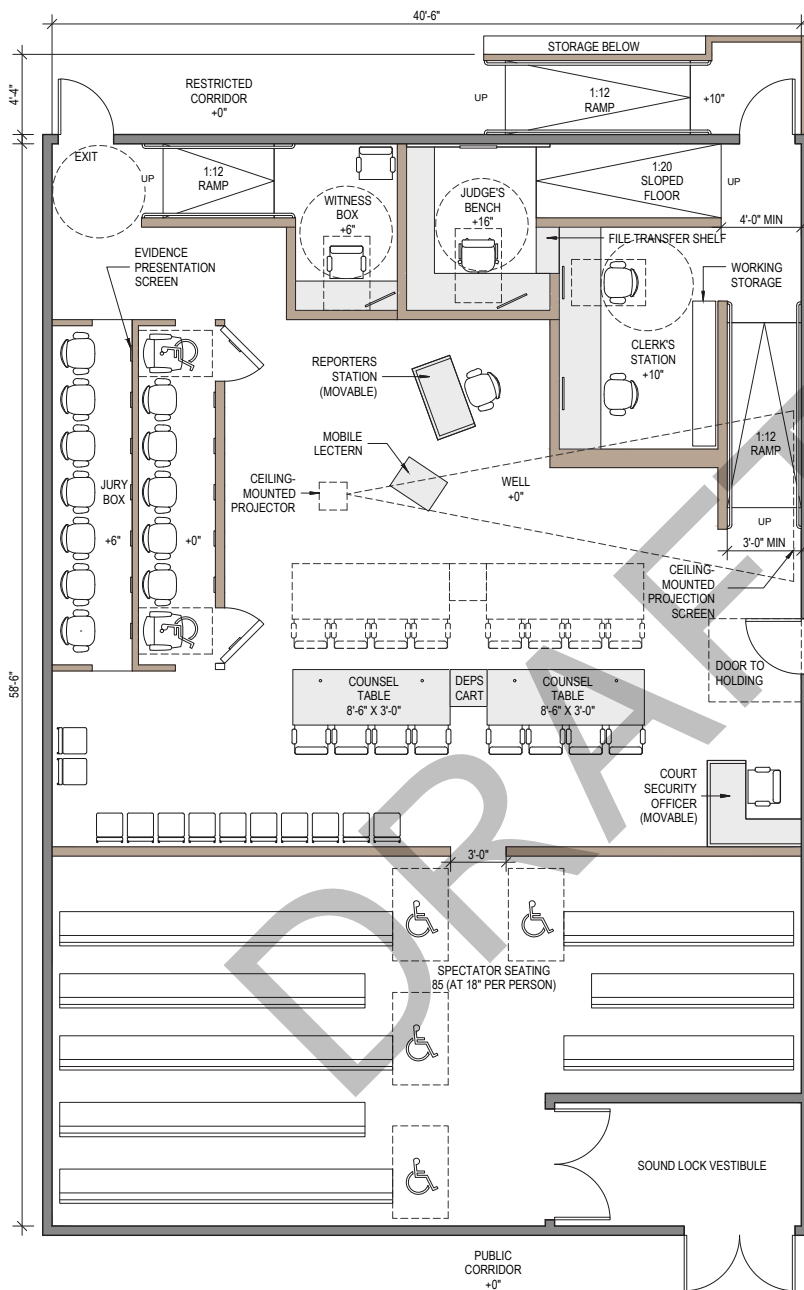

REQUIRED TOOLS

T1 Life Cycle Cost Analysis

T2 CATALOG OF COURTROOM LAYOUTS FOR CALIFORNIA TRIAL COURTS

T2.A Courtroom Layout Overview

T2.B Multipurpose Courtroom Templates

T2.C Courtroom Design Examples

T2.D Holding Core Templates

T3 Integrated Network Architecture

T4 Graphical User Interface Template

T5 In-Custody Interview Room Guidelines

T6 Building Management System Guidelines

Figure T2.12 Typical Large Trial Courtroom—Center Bench D

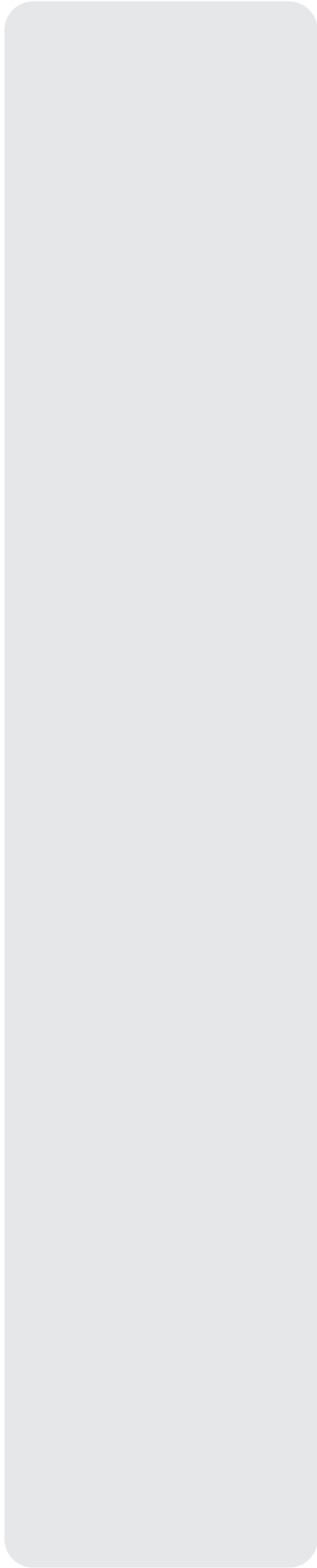

DRAFT

Page intentionally left blank

T2.C COURTROOM DESIGN EXAMPLES

	TOTAL SQUARE FEET*	TOTAL RATED CAPACITY†	PAGE
San Diego Central Courthouse, Trial Courtroom—Center Bench	1,700	46	T2.30
San Bernardino Justice Center, Trial Courtroom—Corner Bench	1,700	50	T2.32
San Diego Central Courthouse, Large Trial Courtroom—Center Bench	2,100	98	T2.34
San Diego Central Courthouse, Double Jury Courtroom—Center Bench	2,100	64	T2.36
San Bernardino Justice Center Double Jury Courtroom—Corner Bench	2,400	92	T2.38
San Diego Central Courthouse, Arraignment Courtroom—Center Bench	1,800	98	T2.40
San Diego Central Courthouse, Family Courtroom— Center Bench	1,700	46	T2.42

* Includes ramp in corridor where applicable.

† Wheelchair spaces added to total spectator seating capacity.

REQUIRED TOOLS

T1 Life Cycle Cost Analysis

T2 CATALOG OF COURTROOM LAYOUTS FOR CALIFORNIA TRIAL COURTS

T2.A Courtroom Layout Overview

T2.B Multipurpose Courtroom Templates

T2.C Courtroom Design Examples

T2.D Holding Core Templates

T3 Integrated Network Architecture

T4 Graphical User Interface Template

T5 In-Custody Interview Room Guidelines

T6 Building Management System Guidelines

**San Diego Central Courthouse
Trial Courtroom—Center Bench**
Courtroom Component Information

COURTROOM TYPE	TOTAL SQUARE FEET (INCLUDES RAMP IN CORRIDOR)	SPECTATOR SEATING AT 18"
Trial	1700	44+2 WC

ELEMENT OR WORKSTATION	FURNITURE/ WIDTH	CASEWORK DEPTH	HEIGHT ABOVE FLOOR	NO. OF OCCUPANTS
Judge	8'0"/5'0"	2'6"/1'6"	+16"	1
Courtroom Clerk	10'0"	2'2"	-	2
Court Security Officer	4'2"	2'2"	-	1
Court Reporter	4'2"	1'9"	-	1
Witness Stand	4'6"	1'8"	+6"	2
Jury Box	N/A	N/A	(1st row) +6" (2nd row) +12"	16
Counsel Tables	8'0"	3'6"	-	3 ea.
Lectern	2'0"	2'0"	-	-

Notes for Future Applications

- Avoid jagged outline to the footprint of the courtroom. Simplify the shape to a rectangular room.
- Avoid jury seats in the jury box located behind counsel tables. All jury seats should be forward of counsel tables.
- Plan for additional chairs to be located forward of the spectator seating gallery.

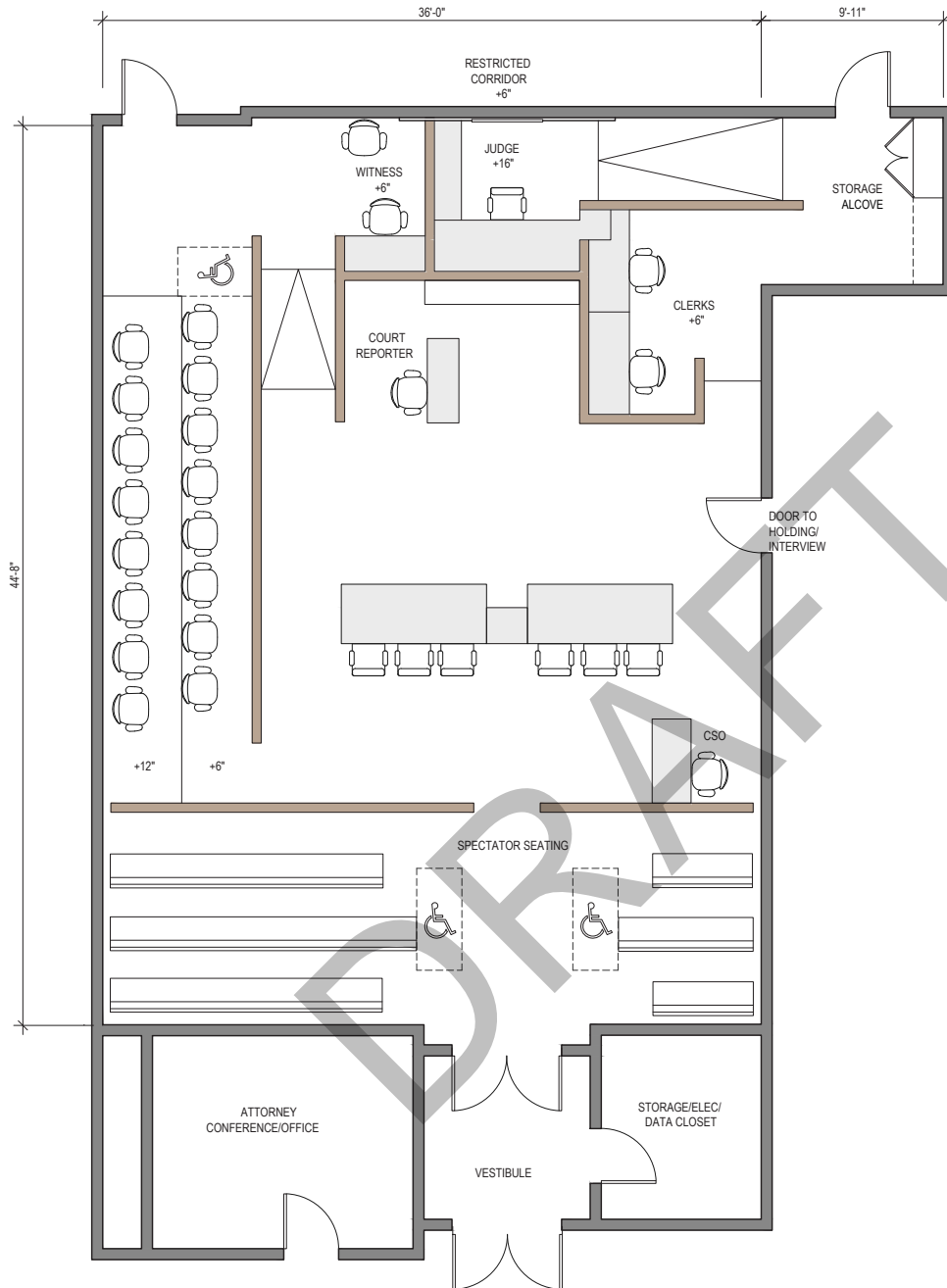

REQUIRED TOOLS

T1 Life Cycle Cost Analysis

T2 CATALOG OF COURTROOM LAYOUTS FOR CALIFORNIA TRIAL COURTS

T2.A Courtroom Layout Overview

T2.B Multipurpose Courtroom Templates

T2.C Courtroom Design Examples

T2.D Holding Core Templates

T3 Integrated Network Architecture

T4 Graphical User Interface Template

T5 In-Custody Interview Room Guidelines

T6 Building Management System Guidelines

Figure T2.13 San Diego Central Courthouse, Trial Courtroom—Center Bench

**San Bernardino Justice Center
Trial Courtroom—Corner Bench**
Courtroom Component Information

COURTROOM TYPE	TOTAL SQUARE FEET (INCLUDES RAMP IN CORRIDOR)	SPECTATOR SEATING AT 18"
Trial	1,700	48+2 WC

ELEMENT OR WORKSTATION	FURNITURE/ WIDTH	CASEWORK DEPTH	HEIGHT ABOVE FLOOR	NO. OF OCCUPANTS
Judge	7'0"/4'9"	2'0"/1'2"	+16"	1
Courtroom Clerk	9'0"	2'2"	+12"	2
Court Security Officer	3'0"	2'4"	-	1
Court Reporter	3'9"	2'0"	-	1
Witness Stand	6'4"	1'7"	+5-1/4"	2
Jury Box	N/A	N/A	(1st row) +0" (2nd row) +6"	14
Counsel Tables	7'10"	3'6"	-	3 ea.
Lectern	-	-	-	-

DRAFT

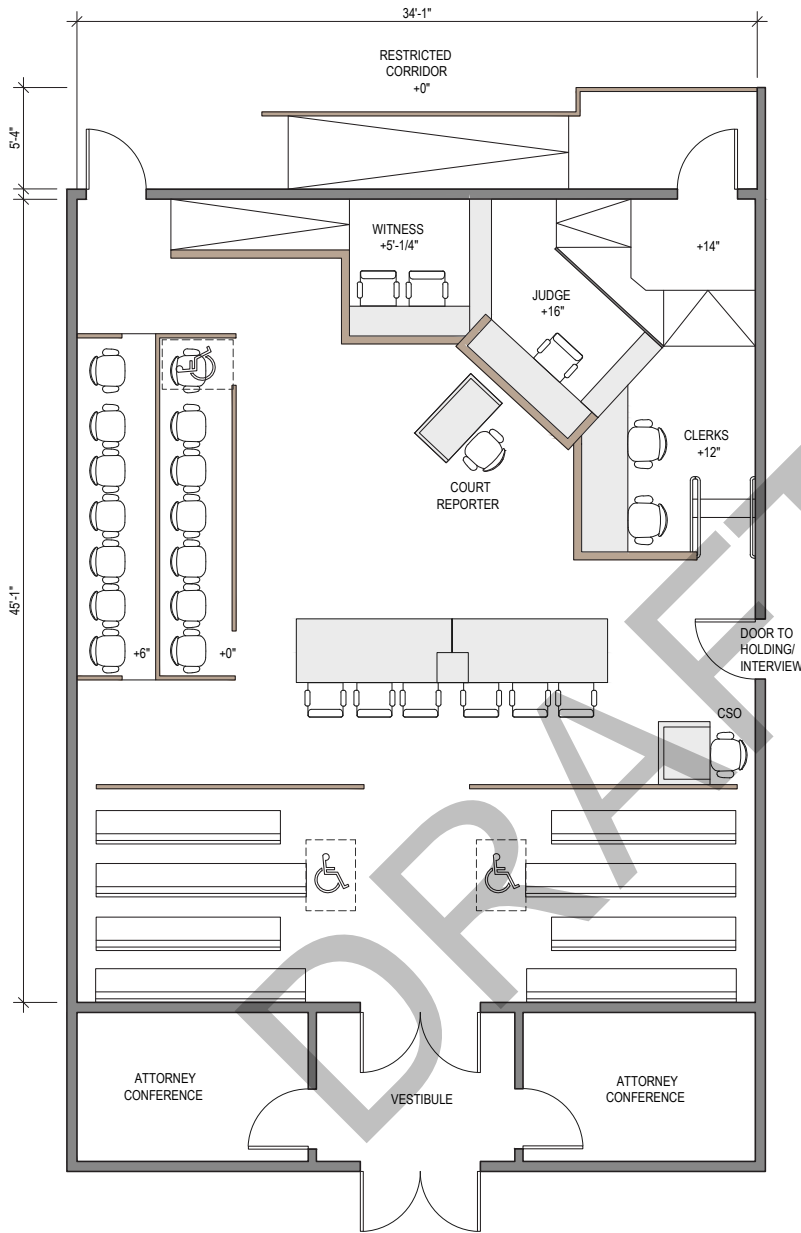

REQUIRED TOOLS

T1 Life Cycle Cost Analysis

T2 CATALOG OF COURTROOM LAYOUTS FOR CALIFORNIA TRIAL COURTS

T2.A Courtroom Layout Overview

T2.B Multipurpose Courtroom Templates

T2.C Courtroom Design Examples

T2.D Holding Core Templates

T3 Integrated Network Architecture

T4 Graphical User Interface Template

T5 In-Custody Interview Room Guidelines

T6 Building Management System Guidelines

Figure T2.14 San Bernardino Justice Center, Trial Courtroom—Corner Bench

San Diego Central Courthouse
Large Trial Courtroom—Center Bench
Courtroom Component Information

COURTROOM TYPE	TOTAL SQUARE FEET (INCLUDES RAMP IN CORRIDOR)	SPECTATOR SEATING AT 18"
Large Trial	2,100	94+4 WC

ELEMENT OR WORKSTATION	FURNITURE/ WIDTH	CASEWORK DEPTH	HEIGHT ABOVE FLOOR	NO. OF OCCUPANTS
Judge	8'0"/5'0"	2'6"/1'6"	+16"	1
Courtroom Clerk	10'0"	2'2"	+6"	2
Court Security Officer	3'10"	2'2"	-	1
Court Reporter	4'2"	1'9"	-	1
Witness Stand	4'6"	1'8"	+6"	2
Jury Box	N/A	N/A	(1st row) +6" (2nd row) +12"	16
Counsel Tables	8'0"	3'6"	-	3 ea.
Lectern	2'0"	2'0"	-	-

Notes for Future Applications

- Avoid jagged outline to the footprint of the courtroom. Simplify the shape to a rectangular room.
- Avoid jury seats in the jury box located behind counsel tables. All jury seats should be forward of counsel tables.
- Plan for additional chairs to be located forward of the spectator seating gallery.
- Maintain clear circulation space next to court security officer desk so that obstructions don't impede quick response to disturbance in the courtroom.

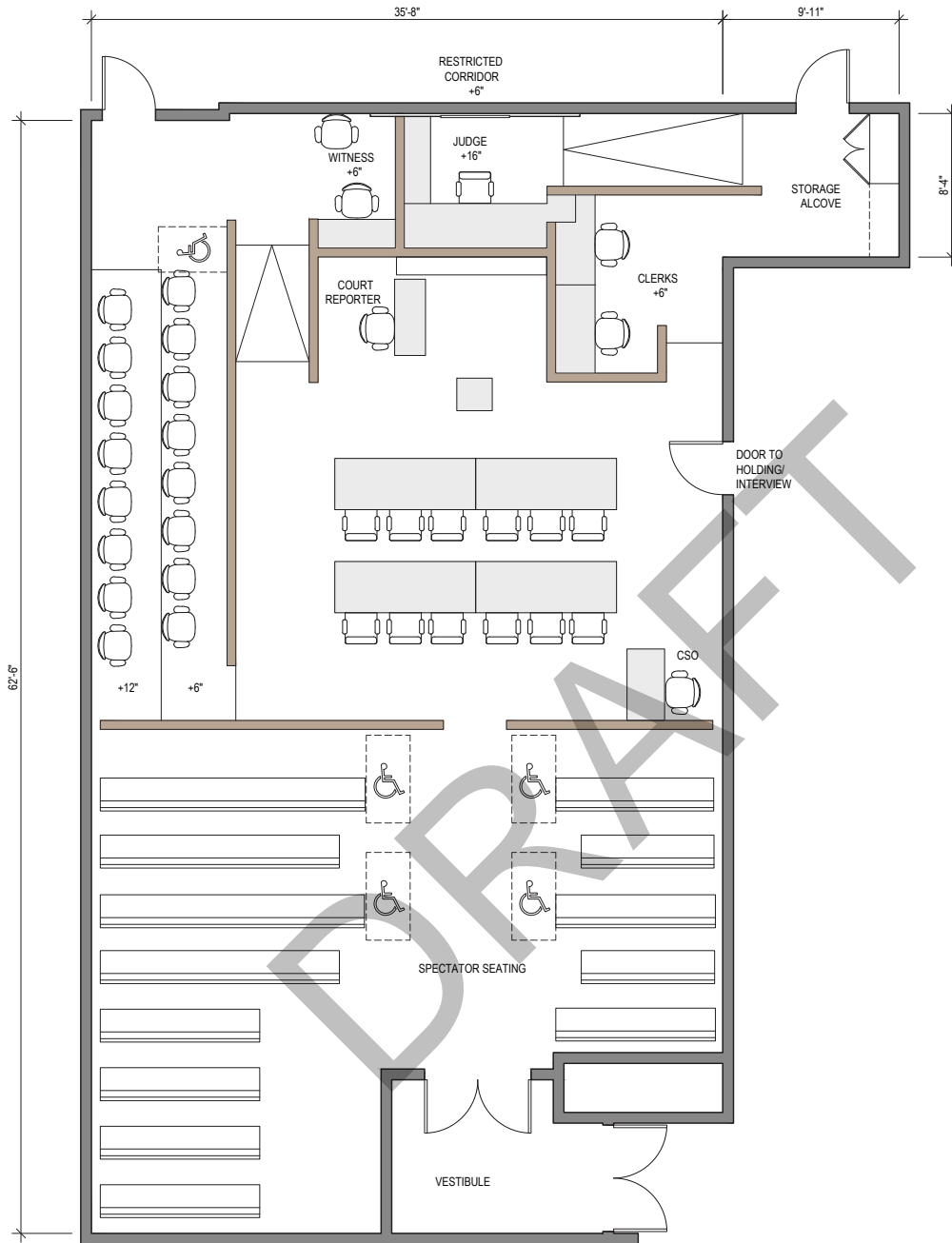

REQUIRED TOOLS

T1 Life Cycle Cost Analysis

T2 CATALOG OF COURTROOM LAYOUTS FOR CALIFORNIA TRIAL COURTS

T2.A Courtroom Layout Overview

T2.B Multipurpose Courtroom Templates

T2.C Courtroom Design Examples

T2.D Holding Core Templates

T3 Integrated Network Architecture

T4 Graphical User Interface Template

T5 In-Custody Interview Room Guidelines

T6 Building Management System Guidelines

Figure T2.15 San Diego Central Courthouse, Large Trial Courtroom—Center Bench

San Diego Central Courthouse
Double Jury Courtroom—Center Bench
Courtroom Component Information

COURTROOM TYPE	TOTAL SQUARE FEET (INCLUDES RAMP IN CORRIDOR)	SPECTATOR SEATING AT 18"
Double Jury	2,100	60+4 WC

ELEMENT OR WORKSTATION	FURNITURE/ WIDTH	CASEWORK DEPTH	HEIGHT ABOVE FLOOR	NO. OF OCCUPANTS
Judge	7'0"/5'0"	2'6"/1'4"	+16"	1
Courtroom Clerk	9'0"	2'2"	+6"	2
Court Security Officer	4'2"	2'2"	-	1
Court Reporter	4'2"	1'9"	-	1
Witness Stand	6'4"	1'8"	+6"	2
Jury Box	N/A	N/A	(1st row) +0" (2nd row) +6" (3rd row) +12"	28
Counsel Tables	7'0"	3'0"	-	3 ea.
Lectern	-	-	-	-

Notes for Future Applications

- Avoid jagged outline to the footprint of the courtroom. Simplify the shape to a rectangular room.
- Avoid jury seats in the jury box located behind counsel tables. All jury seats should be forward of counsel tables.
- Plan for additional chairs to be located forward of the spectator seating gallery.
- Avoid jury box seats that may obstruct sightlines from the bench to spectator seating.
- Provide clear space forward of accessible seats in the jury box.

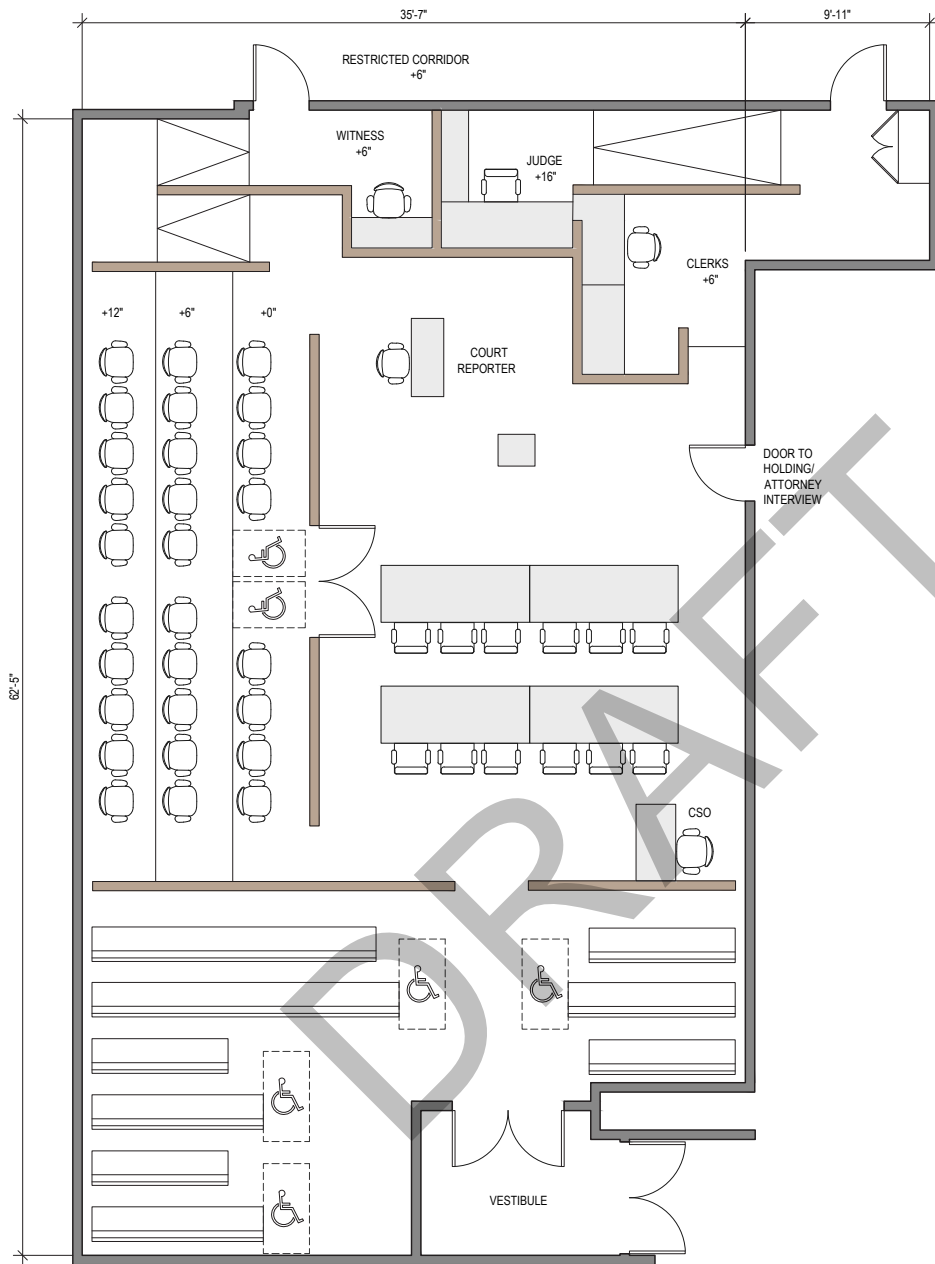

REQUIRED TOOLS

T1 Life Cycle Cost Analysis

T2 CATALOG OF COURTROOM LAYOUTS FOR CALIFORNIA TRIAL COURTS

T2.A Courtroom Layout Overview

T2.B Multipurpose Courtroom Templates

T2.C Courtroom Design Examples

T2.D Holding Core Templates

T3 Integrated Network Architecture

T4 Graphical User Interface Template

T5 In-Custody Interview Room Guidelines

T6 Building Management System Guidelines

Figure T2.16 San Diego Central Courthouse, Double Jury Courtroom—Center Bench

San Bernardino Justice Center
Double Jury Courtroom—Corner Bench
Courtroom Component Information

COURTROOM TYPE	TOTAL SQUARE FEET (INCLUDES RAMP IN CORRIDOR)	SPECTATOR SEATING AT 18"
Double Jury	2,400	88+4 WC

ELEMENT OR WORKSTATION	FURNITURE/ WIDTH	CASEWORK DEPTH	HEIGHT ABOVE FLOOR	NO. OF OCCUPANTS
Judge	7'0"/4'9"	2'0"/1'2"	+16"	1
Courtroom Clerk	9'0"	2'2"	+12"	2
Court Security Officer	7'0"	2'4"	-	2
Court Reporter	4'3"	2'0"	-	1
Witness Stand	6'4"	1'7"	+5-1/4"	2
Jury Box	N/A	N/A	(1st row) +0" (2nd row) +6" (3rd row) +12"	26
Counsel Tables	7'0"	3'0"	-	2 ea.
Lectern	-	-	-	-

Notes for Future Applications

- Avoid long, narrow courtroom.
- Avoid jury seats in the jury box located behind counsel tables. All jury seats should be forward of counsel tables.
- Plan for additional chairs to be located forward of the spectator seating gallery.
- Avoid jury box seats that may obstruct sightlines from the bench to spectator seating.
- Provide sightlines from the bench to all the seats in the spectator gallery.
- Locate court security officer closer to the gallery.

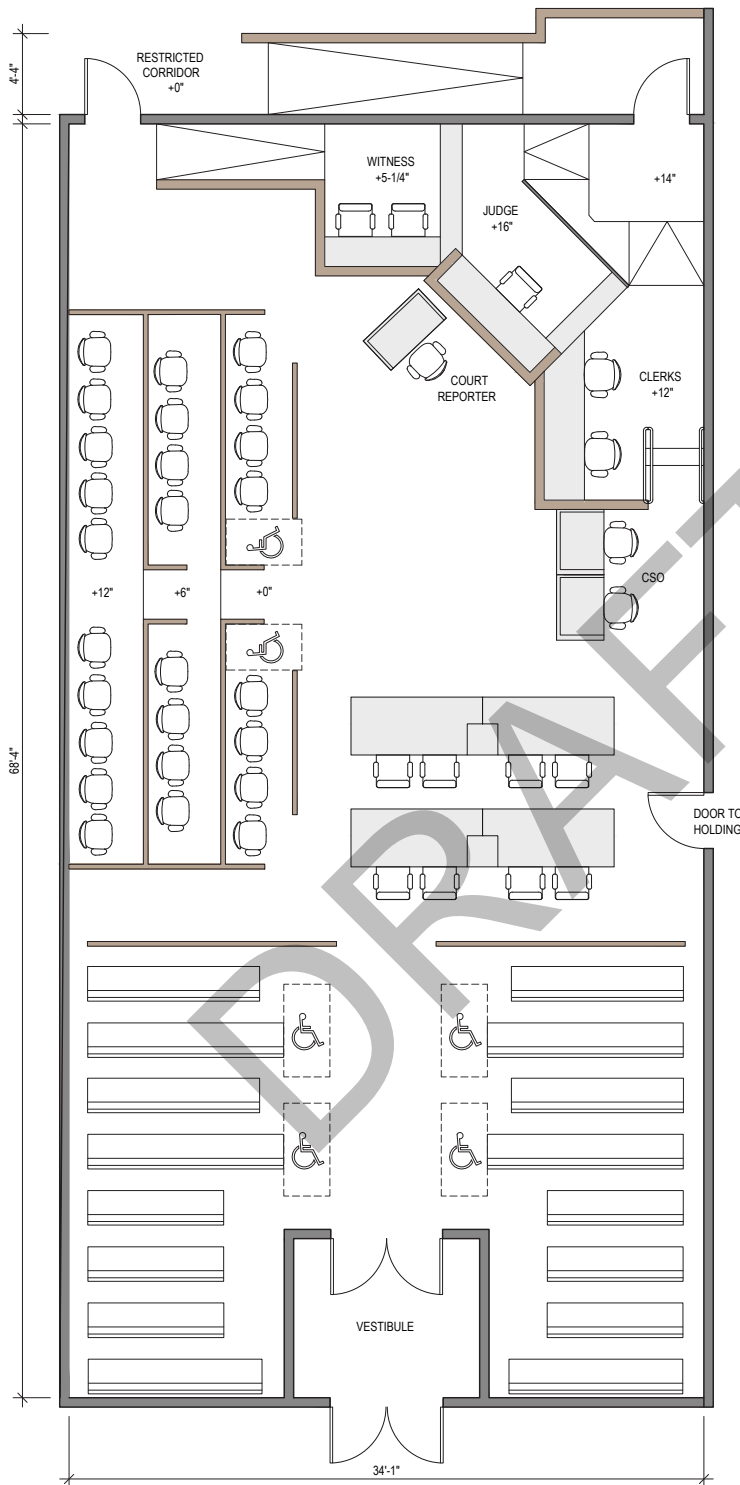

REQUIRED TOOLS

T1 Life Cycle Cost Analysis

T2 CATALOG OF COURTROOM LAYOUTS FOR CALIFORNIA TRIAL COURTS

T2.A Courtroom Layout Overview

T2.B Multipurpose Courtroom Templates

T2.C Courtroom Design Examples

T2.D Holding Core Templates

T3 Integrated Network Architecture

T4 Graphical User Interface Template

T5 In-Custody Interview Room Guidelines

T6 Building Management System Guidelines

Figure T2.17 San Bernardino Justice Center, Double Jury Courtroom—Corner Bench

San Diego Central Courthouse
Arraignment Courtroom—Center Bench
Courtroom Component Information

COURTROOM TYPE	TOTAL SQUARE FEET (INCLUDES RAMP IN CORRIDOR)	SPECTATOR SEATING AT 18"
Arraignment Courtroom	1,800	94+4 WC

ELEMENT OR WORKSTATION	FURNITURE/ WIDTH	CASEWORK DEPTH	HEIGHT ABOVE FLOOR	NO. OF OCCUPANTS
Judge	6'0"/3'8"	2'6"/1'3"	+16"	1
Courtroom Clerk	8'2"	2'6"	+6"	2
Court Security Officer	4'2"	2'2"	-	1
Court Reporter	4'2"	1'9"	-	1
Witness Stand	N/A		N/A	
Jury Box	N/A	N/A	N/A	N/A
Counsel Tables	6'0"	3'0"	-	2 ea.
Lectern	2'6"	2'0"	-	-

Notes for Future Applications

- Avoid jagged outline to the footprint of the courtroom. Simplify the shape to a rectangular room.
- Use the layout requirements for attorney-client interview rooms provided in chapter 25, Attorney-Client Interview Room Guidelines.
- Avoid long, narrow courtroom.
- Plan for additional chairs to be located forward of the spectator seating gallery.
- Locate door to arraignment dock forward of counsel table.
- Provide sightlines from the bench to all the seats in the spectator gallery.

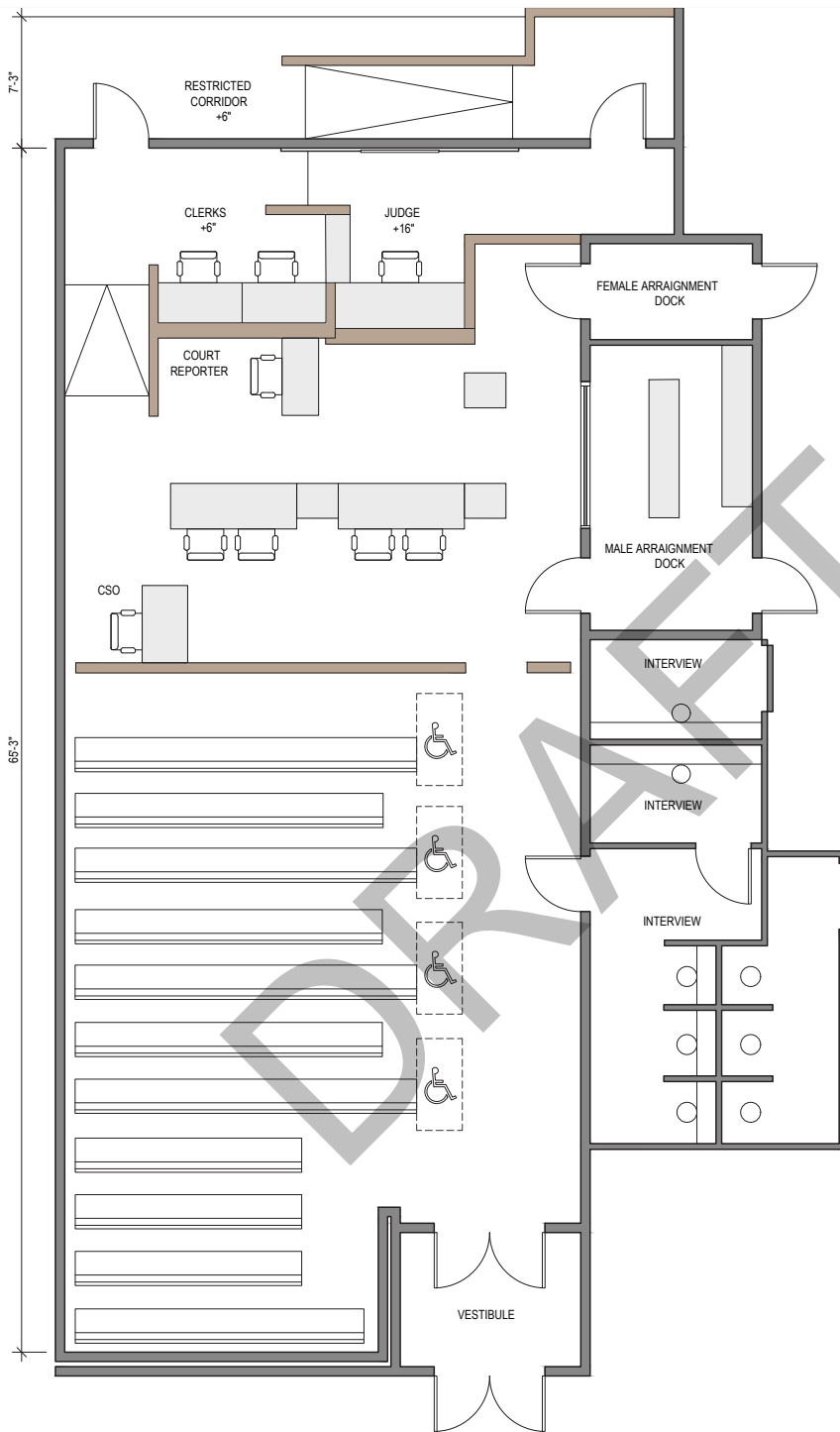

REQUIRED TOOLS

T1 Life Cycle Cost Analysis

T2 CATALOG OF COURTROOM LAYOUTS FOR CALIFORNIA TRIAL COURTS

T2.A Courtroom Layout Overview

T2.B Multipurpose Courtroom Templates

T2.C Courtroom Design Examples

T2.D Holding Core Templates

T3 Integrated Network Architecture

T4 Graphical User Interface Template

T5 In-Custody Interview Room Guidelines

T6 Building Management System Guidelines

Figure T2.18 San Diego Central Courthouse, Arraignment Courtroom—Center Bench

**San Diego Central Courthouse
Family Courtroom—Center Bench**
Courtroom Component Information

COURTROOM TYPE	TOTAL SQUARE FEET (INCLUDES RAMP IN CORRIDOR)	SPECTATOR SEATING AT 18"
Family	1,700	44+2 WC

ELEMENT OR WORKSTATION	FURNITURE/ WIDTH	CASEWORK DEPTH	HEIGHT ABOVE FLOOR	NO. OF OCCUPANTS
Judge	8'0"	2'6"	+16"	1
Courtroom Clerk	10'0"	2'2"	+6"	2
Court Security Officer	4'2"	2'2"	-	1
Court Reporter	4'2"	1'9"	-	1
Witness Stand	4'6"	1'8"	+6"	2
Jury Box	N/A	N/A	N/A	N/A
Counsel Tables	8'0"	3'0"	-	3 ea.
Lectern	2'0"	2'0"	-	-

Notes for Future Applications

- Avoid jagged outline to the footprint of the courtroom. Simplify the shape to a rectangular room.
- Plan for additional chairs to be located forward of the spectator seating gallery.

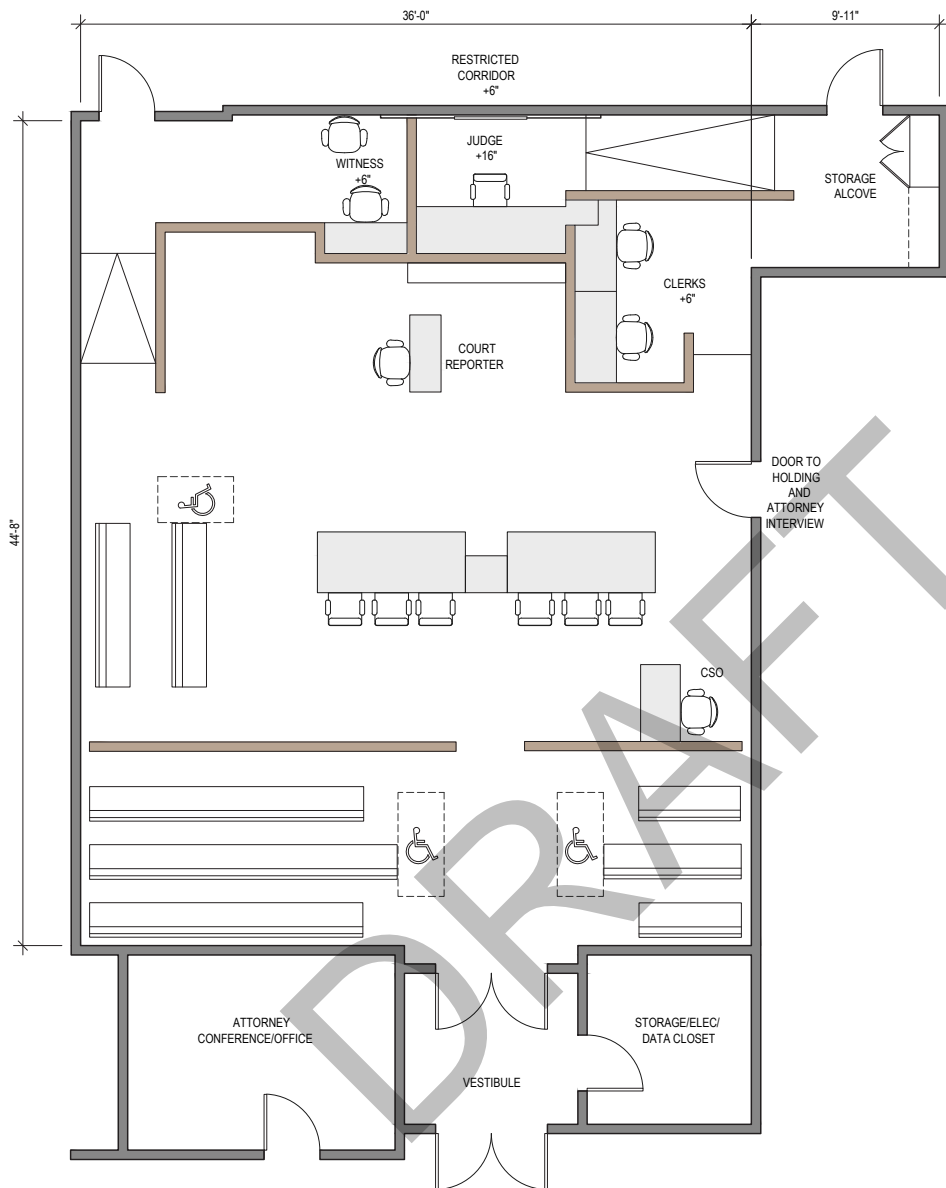

REQUIRED TOOLS

T1 Life Cycle Cost Analysis

T2 CATALOG OF COURTROOM LAYOUTS FOR CALIFORNIA TRIAL COURTS

T2.A Courtroom Layout Overview

T2.B Multipurpose Courtroom Templates

T2.C Courtroom Design Examples

T2.D Holding Core Templates

T3 Integrated Network Architecture

T4 Graphical User Interface Template

T5 In-Custody Interview Room Guidelines

T6 Building Management System Guidelines

Figure T2.19 San Diego Central Courthouse, Family Courtroom—Center Bench

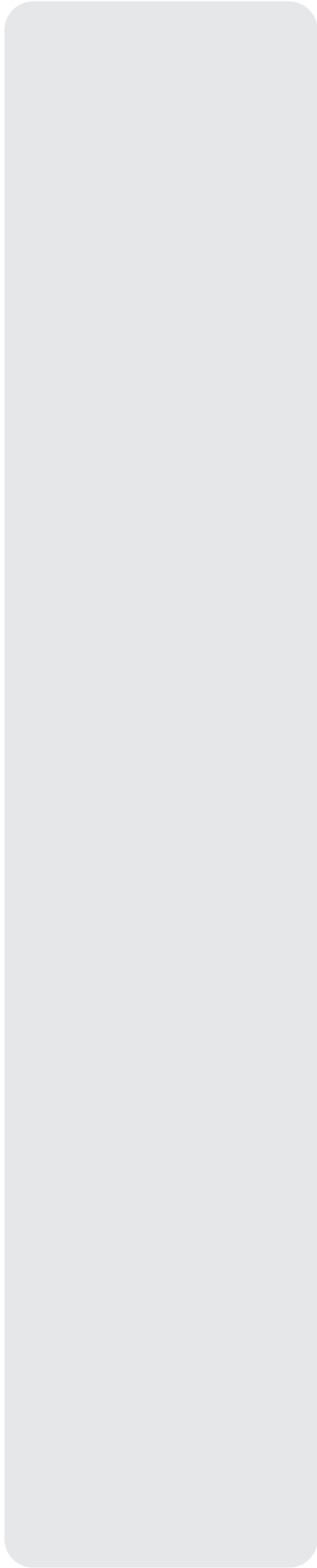

DRAFT

Page intentionally left blank

T2.D HOLDING CORE TEMPLATES

	TOTAL SQUARE FEET	TOTAL RATED CAPACITY	PAGE
Typical Holding Core— 8" CMU Walls	709	7	T2.46
Typical Holding Core— 6" CMU Walls	690	7	T2.47
Typical Holding Core— 6" CMU Walls and 2" Metal Panel Walls at Holding	672	7	T2.48

DRAFT

REQUIRED TOOLS

- T1 Life Cycle Cost Analysis
- T2 CATALOG OF COURTROOM LAYOUTS FOR CALIFORNIA TRIAL COURTS**
 - T2.A Courtroom Layout Overview
 - T2.B Multipurpose Courtroom Templates
 - T2.C Courtroom Design Examples
 - T2.D Holding Core Templates
- T3 Integrated Network Architecture
- T4 Graphical User Interface Template
- T5 In-Custody Interview Room Guidelines
- T6 Building Management System Guidelines

Typical Holding Core—8" CMU Walls
Holding Core Information

TOTAL SQUARE FEET	TOTAL RATED CAPACITY	TOTAL CELL COUNT
709	7	2

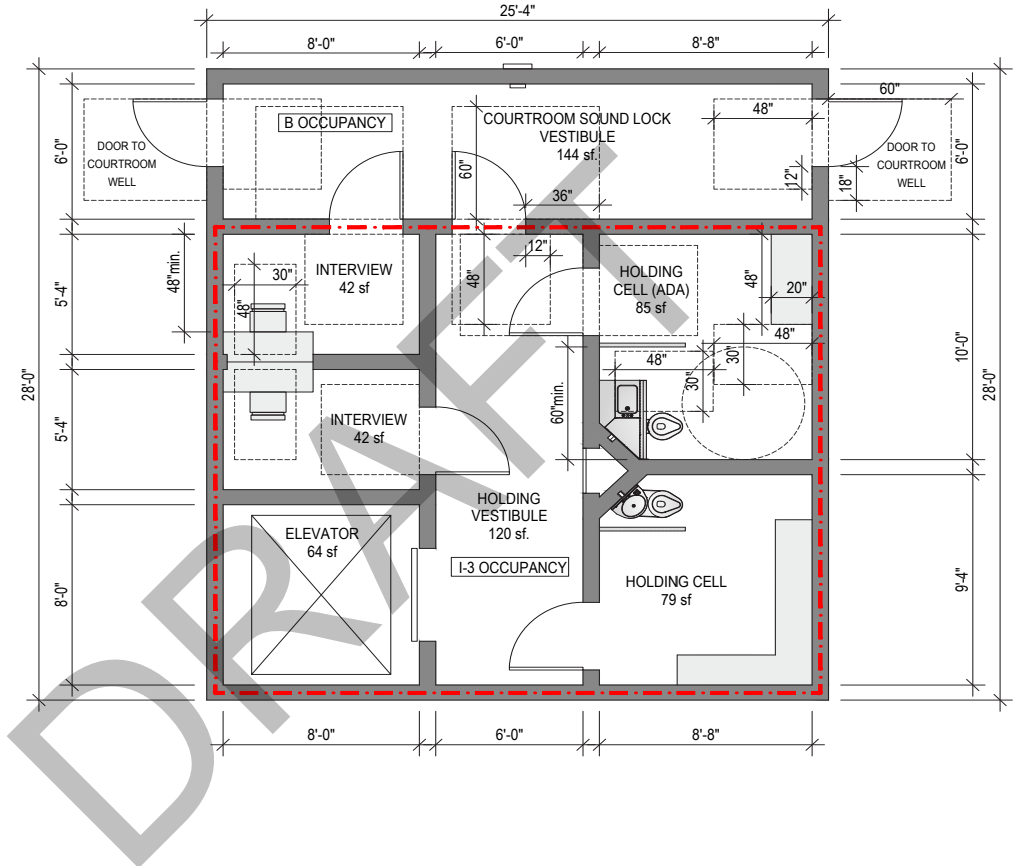

Note: The red line indicates rated wall boundary for institutional-occupancy separation.
 ADA = Americans with Disabilities Act.
 sf = square feet.

Figure T2.20 Typical Holding Core—8" CMU Walls

Typical Holding Core—6" CMU Walls
Holding Core Information

TOTAL SQUARE FEET	TOTAL RATED CAPACITY	TOTAL CELL COUNT
690	7	2

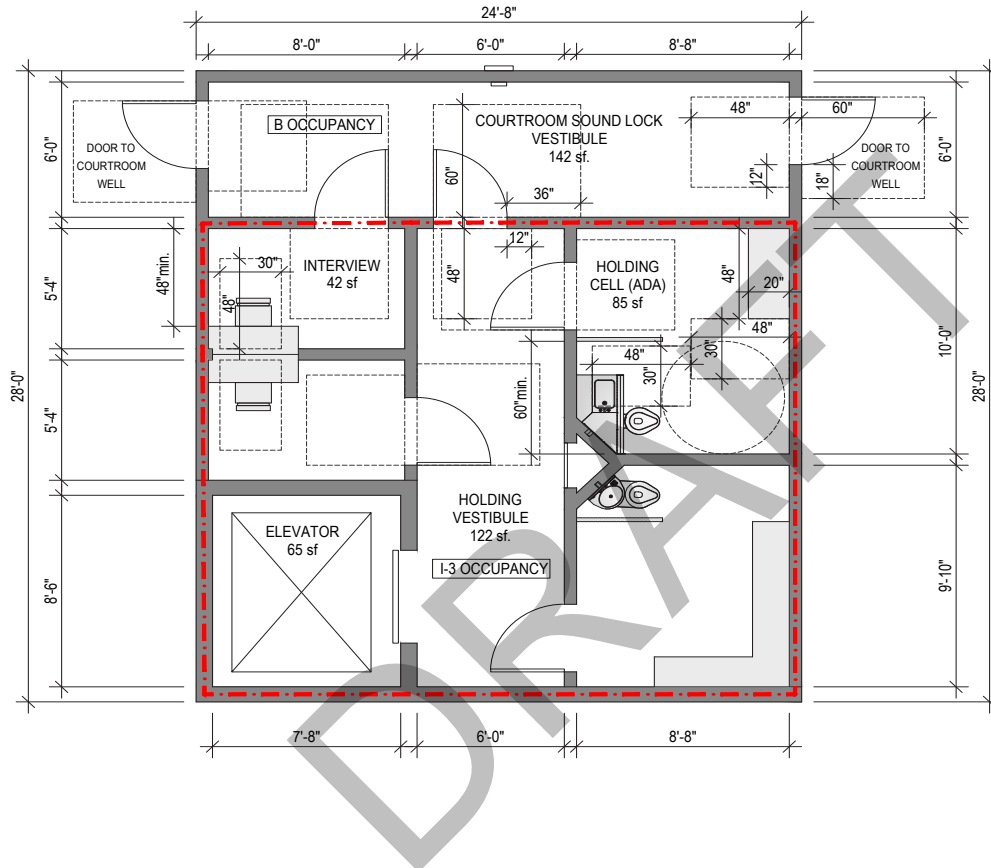

Note: The red line indicates rated wall boundary for institutional-occupancy separation.
 ADA = Americans with Disabilities Act.
 sf = square feet.

Figure T2.21 Typical Holding Core—6" CMU Walls

REQUIRED TOOLS

T1 Life Cycle Cost Analysis

T2 CATALOG OF COURTROOM LAYOUTS FOR CALIFORNIA TRIAL COURTS

T2.A Courtroom Layout Overview

T2.B Multipurpose Courtroom Templates

T2.C Courtroom Design Examples

T2.D Holding Core Templates

T3 Integrated Network Architecture

T4 Graphical User Interface Template

T5 In-Custody Interview Room Guidelines

T6 Building Management System Guidelines

Typical Holding Core—6" CMU Walls and 2" Metal Panel Walls at Holding
Holding Core Information

TOTAL SQUARE FEET	TOTAL RATED CAPACITY	TOTAL CELL COUNT
672	7	2

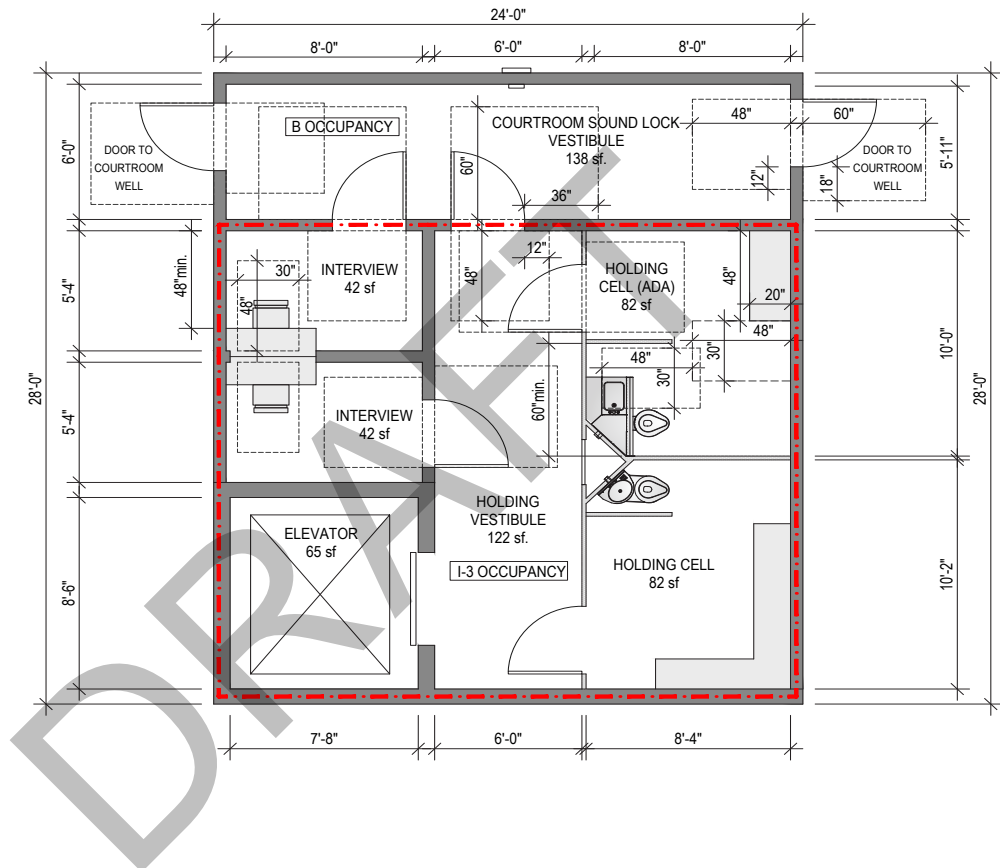

Note: The red line indicates rated wall boundary for institutional-occupancy separation.
 ADA = Americans with Disabilities Act.
 sf = square feet.

Figure T2.22 Typical Holding Core—6" CMU Walls and 2" Metal Panel Walls at Holding

T3

REQUIRED TOOLS

INTEGRATED NETWORK ARCHITECTURE

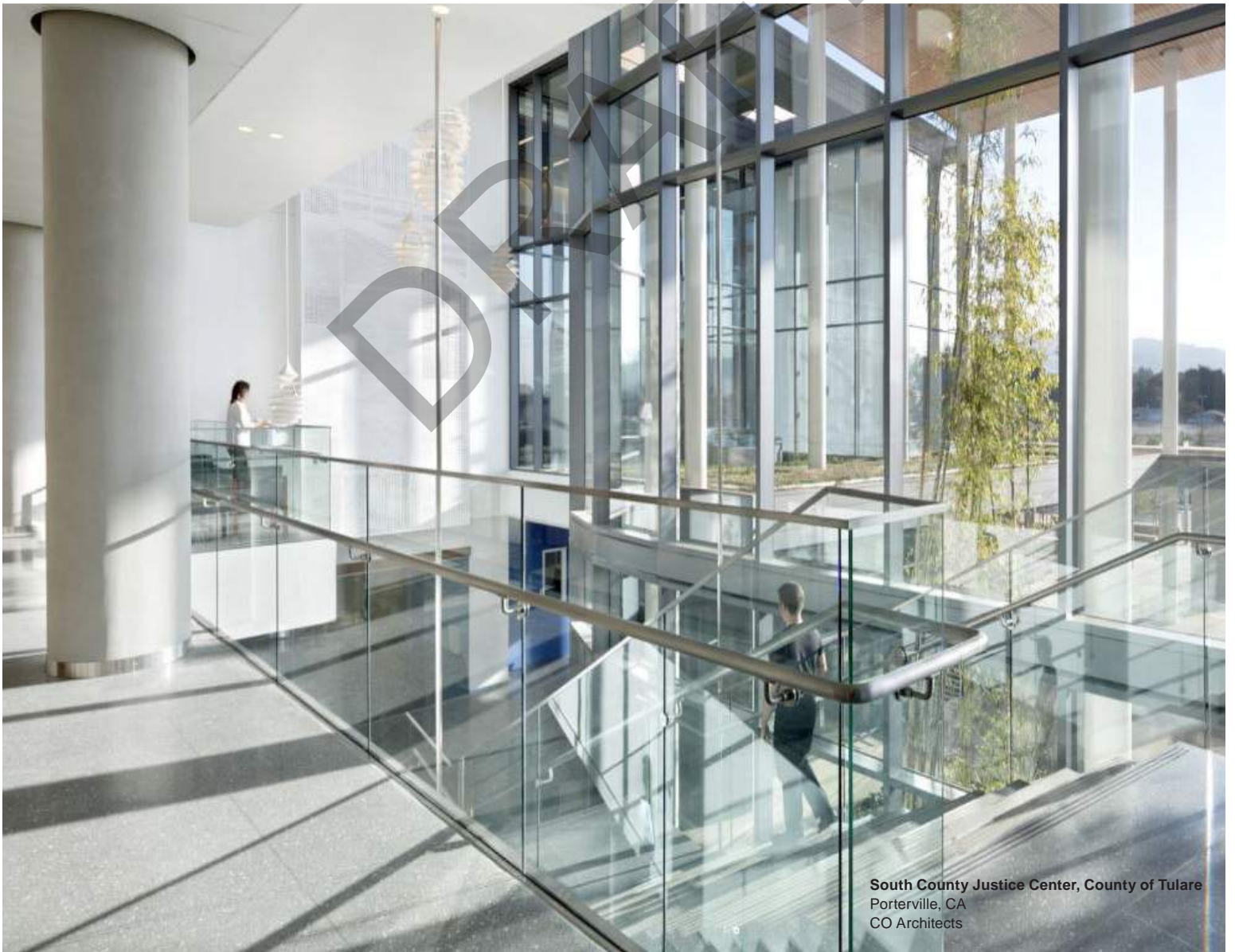

South County Justice Center, County of Tulare
Porterville, CA
CO Architects

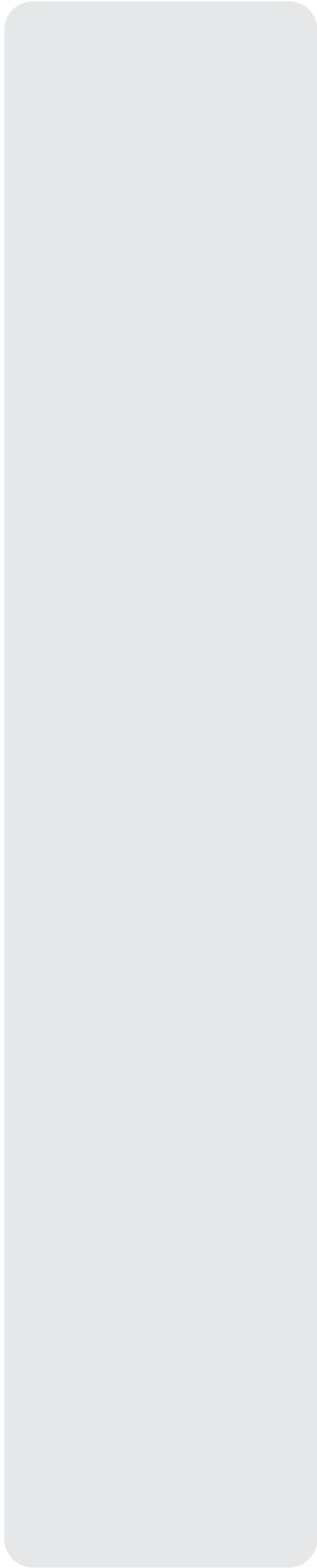

DRAFT

Page intentionally left blank

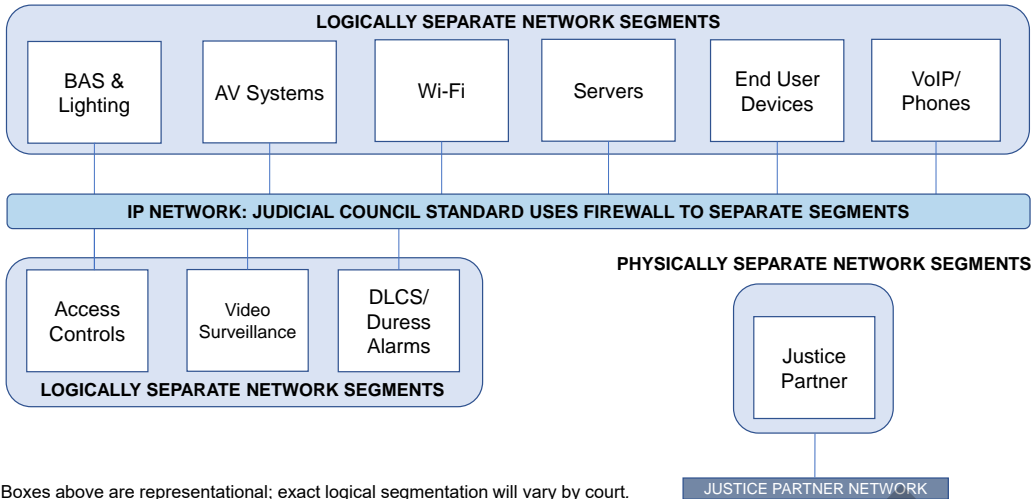

Boxes above are representational; exact logical segmentation will vary by court.

- BAS = building automation system.
- AV = audiovisual.
- VoIP = Voice over Internet Protocol.
- DLCS = detention lock control system.

Figure T3.1 Overview of Integrated Network Architecture

DRAFT

REQUIRED TOOLS

- T1 Life Cycle Cost Analysis
- T2 Catalog of Courtroom Layouts for California Trial Courts

T3 INTEGRATED NETWORK ARCHITECTURE

- T4 Graphical User Interface Template
- T5 In-Custody Interview Room Guidelines
- T6 Building Management System Guidelines

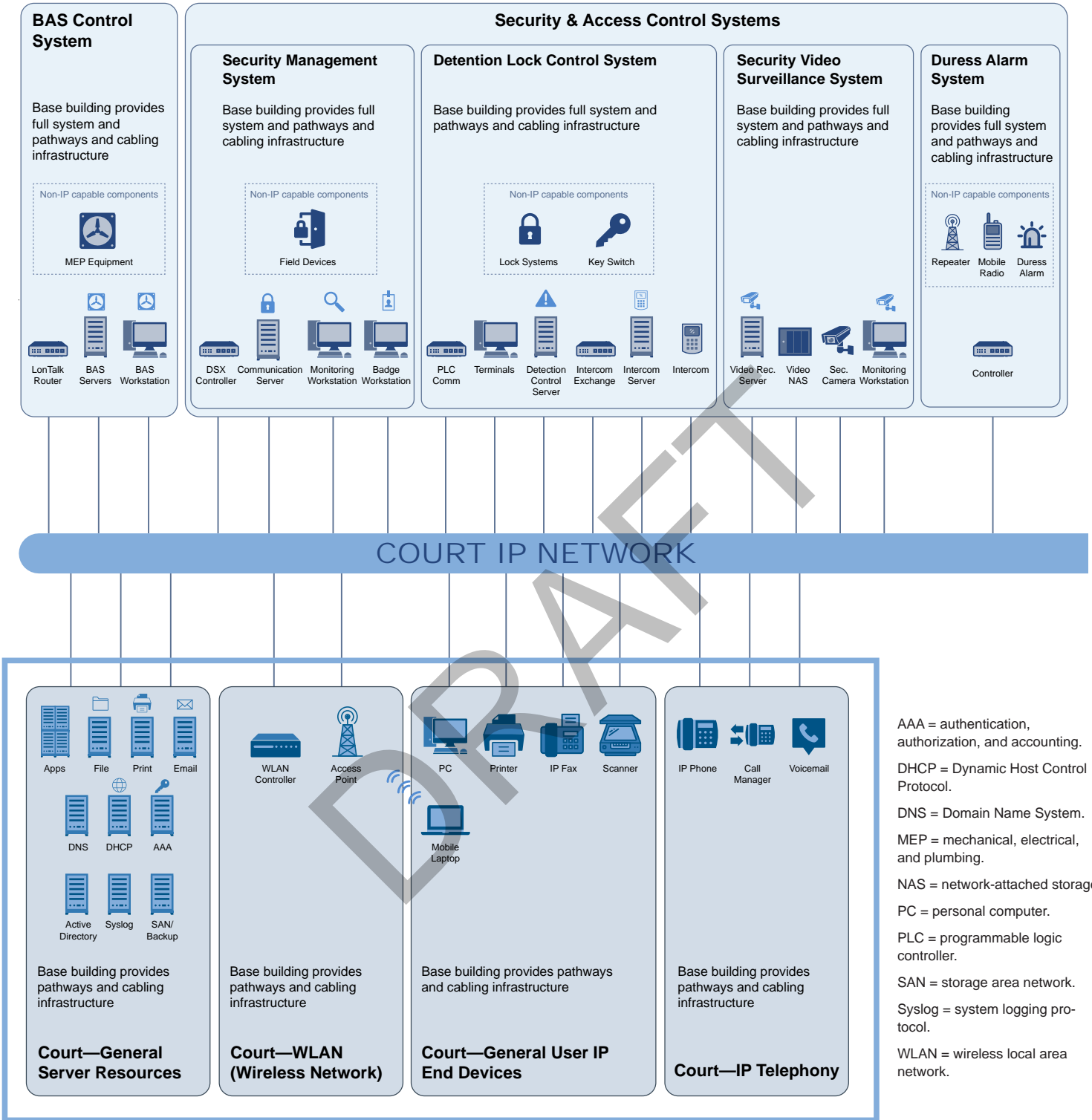
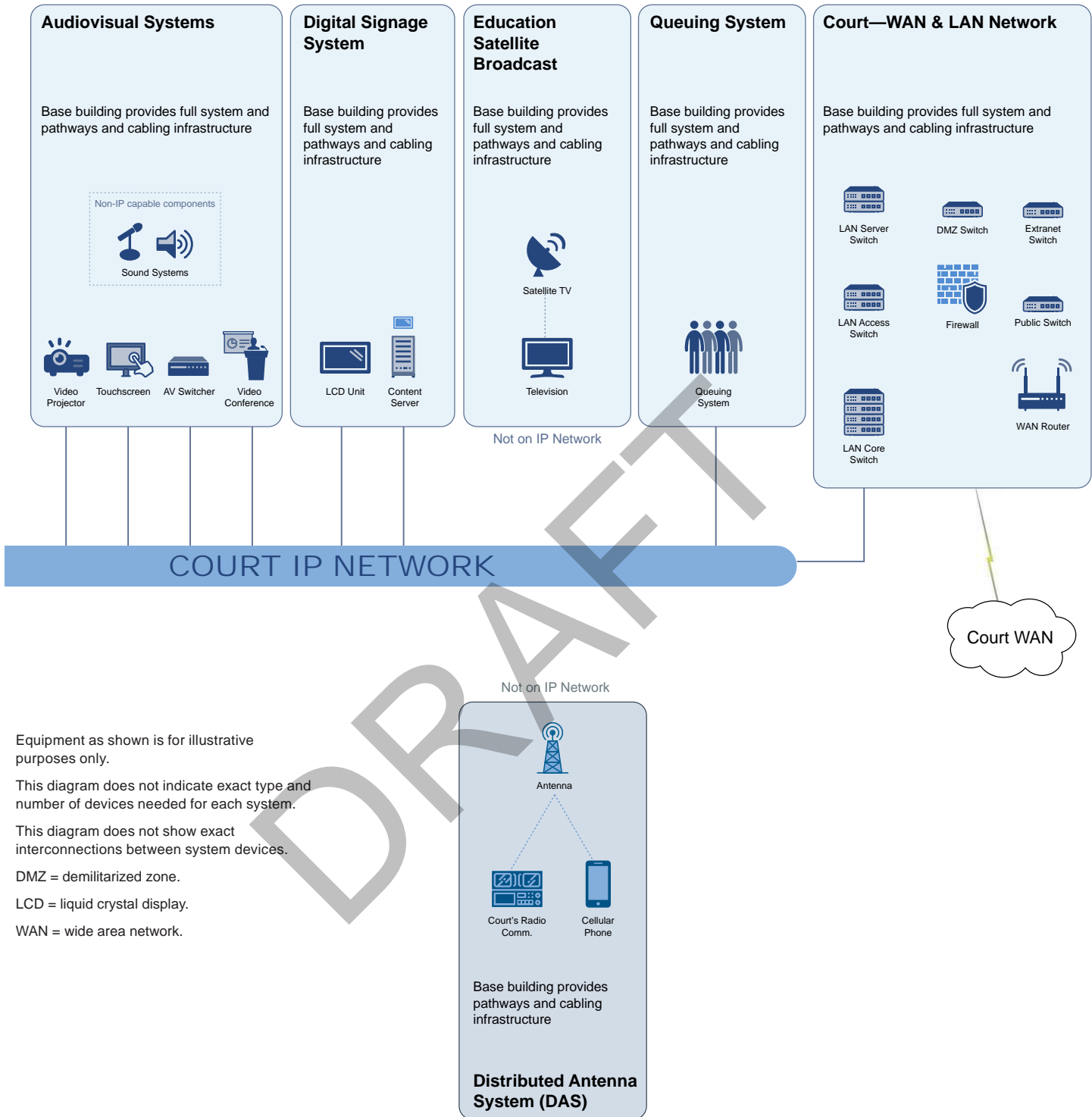

Figure T3.2 Integrated Network Architecture by Systems

Figure T3.2 continues on next page



Equipment as shown is for illustrative purposes only.

This diagram does not indicate exact type and number of devices needed for each system.

This diagram does not show exact interconnections between system devices.

DMZ = demilitarized zone.

LCD = liquid crystal display.

WAN = wide area network.

Figure T3.2 Integrated Network Architecture by Systems *continued*

DRAFT

T4

REQUIRED TOOLS

GRAPHICAL USER INTERFACE TEMPLATE

SECTION	TOPIC	PAGE
T4.A	Introduction	T4.2
T4.B	Page Descriptions	T4.2



T4.A INTRODUCTION

The GUI (graphical user interface) template is provided as a starting point for the design of the courtroom touchscreen control panel located at either the judge, clerk, or bailiff’s desk. It must be customized based on the specific capabilities and layout of each courtroom. Control panels for ancillary spaces should follow the same general layout, as much as possible. The following pages describe the step-by-step instructions to design and use the template.

T4.B PAGE DESCRIPTIONS

Startup Page

If the page in figure T4.1 is visible, then the audiovisual (AV) system is off. Tap the seal to start the system.

Figure T4.1 Audiovisual System Startup Page



Audio Video Page

At the top of the resulting page—the simplified Audio Video page (figure T4.2)—is a ribbon of all the page views. On the ribbon, tap the tab of the page you wish to view.

Figure T4.2 Simplified Audio Video

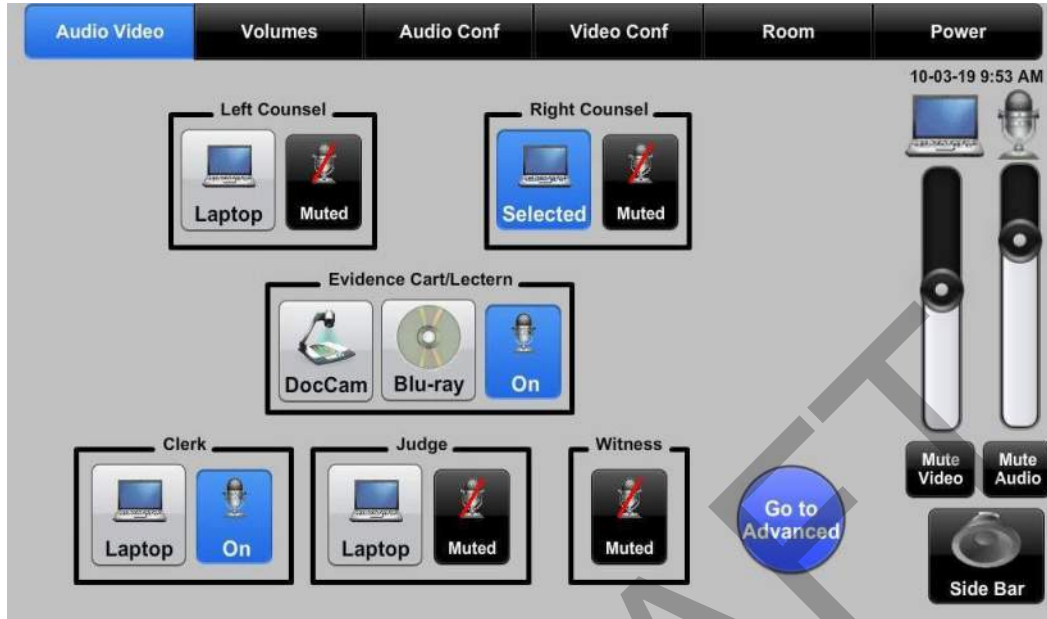

On the Audio Video page, tap the applicable Laptop, DocCam, or Blu-ray button to connect the device at the indicated location to the display system. For example, figure T4.2 shows the laptop in the Right Counsel group as Selected, which means it is connected to the display system. To switch to the judge’s laptop, tap the Laptop button in the Judge group.

Tapping any display button (see icons below) also turns on the courtroom projector and lowers the projection screen.



The Audio Video page also shows whether a microphone is on or off. The microphone button toggles between On and Muted. For example, figure T4.2 shows that the microphones at the lectern and clerk’s desk are on. Tap the Muted button to turn a microphone on and the On button to turn it off. On this simplified page, the microphone buttons in the Left Counsel or Right Counsel group, when tapped, mute and unmute both of the two microphones in those areas. To control them separately, see figure T4.3.



REQUIRED TOOLS

- T1 Life Cycle Cost Analysis
- T2 Catalog of Courtroom Layouts for California Trial Courts
- T3 Integrated Network Architecture

T4 GRAPHICAL USER INTERFACE TEMPLATE

- T4.A Introduction
- T4.B Page Descriptions

- T5 In-Custody Interview Room Guidelines
- T6 Building Management System Guidelines

Tapping the Go to Advanced button toggles from the simplified page to the advanced page.



The next set of buttons appears on every page of the AV system.

- The two volume sliders control either the laptop volume or the master microphone volume.
- The Mute Video button mutes all video and Mute Audio mutes all audio.
- The Side Bar button turns on pink noise, mutes all microphones, and optionally sends audio from the sidebar to the court reporter. A pop-up window volume control allows the volume of the pink noise to be adjusted.



The advanced Audio Video page (figure T4.3) differs, in part, from the simplified page in that it has buttons for each of the two counsel microphones on each table (rather than one button for both), along with buttons that control arraignment dock and holding cell speakers, if available.

Figure T4.3 Advanced Audio Video Page



Another feature of the advanced page is the Wireless group, with buttons that control the wireless microphone. The default is to have the wireless microphone routed to the ceiling speakers. If the Route to Speakers button is tapped, the wireless microphone is routed to the infrared (IR) headsets in the courtroom. If a language interpreter is in the room, the interpreter can use the wireless microphone to translate what is being said in the courtroom directly to anyone wearing a wireless headset.



Tapping the Go to Simplified button toggles the page back from the advanced to the simplified Audio Video page.



DRAFT

REQUIRED TOOLS

- T1 Life Cycle Cost Analysis
- T2 Catalog of Courtroom Layouts for California Trial Courts
- T3 Integrated Network Architecture

T4 GRAPHICAL USER INTERFACE TEMPLATE

- T4.A Introduction
- T4.B Page Descriptions
- T5 In-Custody Interview Room Guidelines
- T6 Building Management System Guidelines

Volumes Page

Figure T4.4 Volumes Page

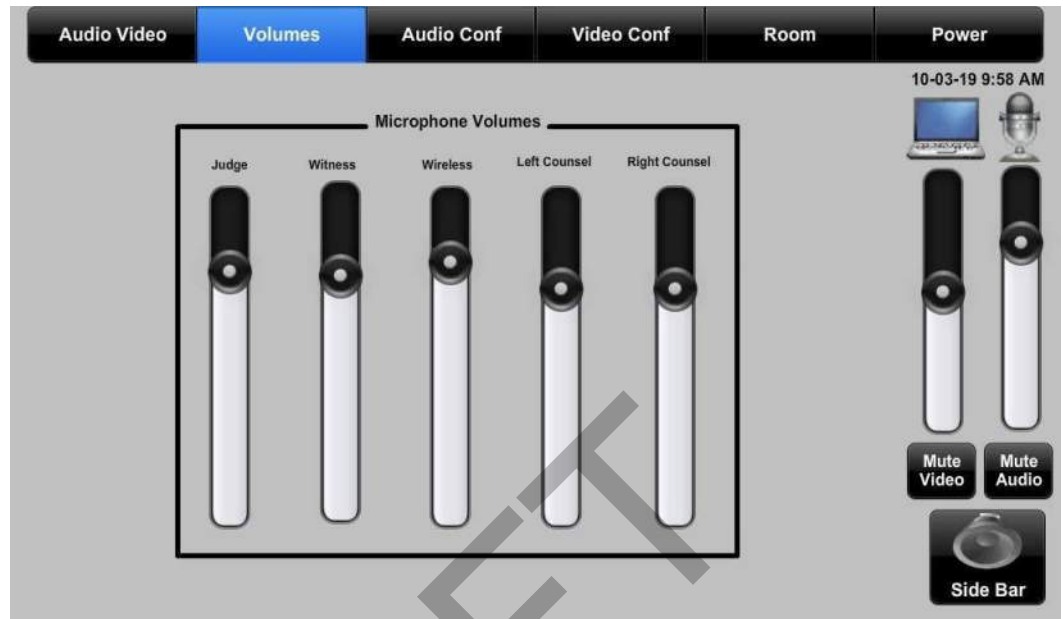

The Volumes page has slider volume controls for each courtroom microphone.

DRAFT

Audio Conf Page

Figure T4.5 Audio Conf Page



The Audio Conf page allows audio telephone calls with the microphones and speakers already used for amplification within the courtroom. Calls can be placed either by tapping the Dialtone button first or by entering the number and then tapping the Dial button. The volume control then adjusts the volume of the received telephone audio. The page can display the court's phone number and a message indicating to "Dial 9 for an outside line."

The Speakers button and Ch 2 button control the routing of the telephone audio feed. The default is to the ceiling speakers. If the language translator has been called on the telephone, the translator can hear what is being said in the courtroom and translate it for anyone who is wearing a wireless IR headset. If the Speakers button is blue, the system is set to the default, routing the telephone audio feed to the ceiling speakers. If the Ch 2 button is tapped, the blue Speakers button toggles to black and the Ch 2 button turns blue, changing the feed to channel 2 on the headsets.



The Ringer Disabled button indicates that the telephone ringer is disabled, so the courtroom will not be disturbed if someone calls the phone number of the courtroom. The ringer is disabled by default. If the button is tapped, the ringer is activated.



The On microphone button acts as a privacy button, either enabling or disabling the sending of audio from the courtroom over the telephone.



REQUIRED TOOLS

- T1 Life Cycle Cost Analysis
- T2 Catalog of Courtroom Layouts for California Trial Courts
- T3 Integrated Network Architecture

T4 GRAPHICAL USER INTERFACE TEMPLATE

- T4.A Introduction
- T4.B Page Descriptions

- T5 In-Custody Interview Room Guidelines
- T6 Building Management System Guidelines

Video Conf Page

Figure T4.6 Video Conf Page



The Video Conf page allows the making of videoconference calls with the cameras, microphones, and speakers installed in the courtroom. This page shall include mute functions for audio and video. Both a dial pad and a keyboard icon shall be included. Camera controls shall include manual zoom capabilities along with preset views. If multiple cameras are provided, the ability to toggle between views and controls shall be included. Routing of the video conference to the Courtroom display is required. This page shall be customized based on the specific videoconference system installed.

DRAFT

Room Page

Figure T4.7 Room Page

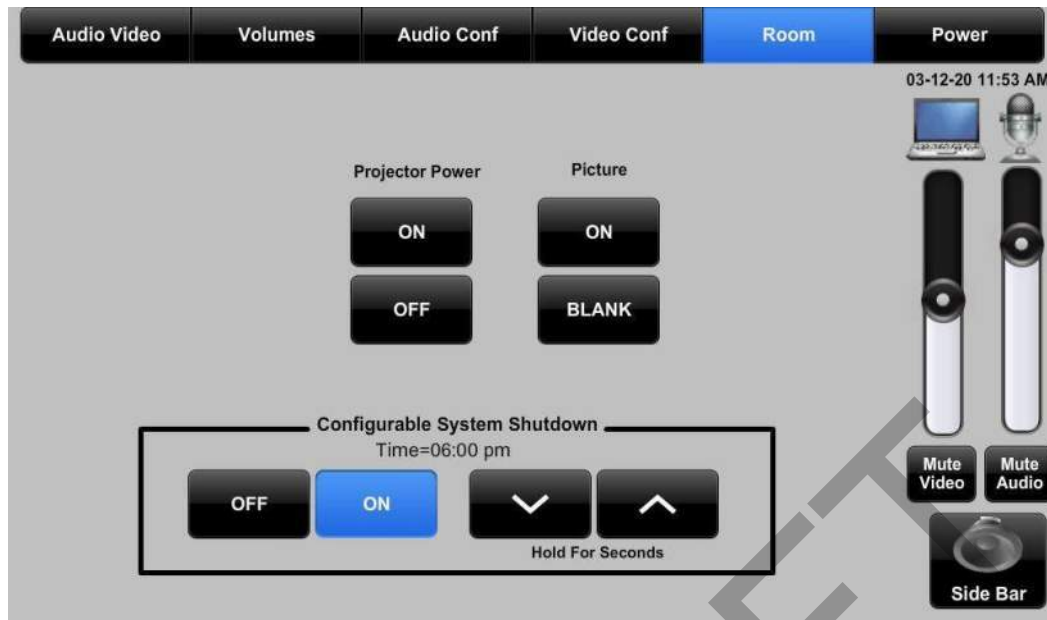

The Room page contains seldom-used controls and backup controls. It allows the user to turn projector power on and off and to momentarily “blank” the picture image.

The Configurable System Shutdown group controls the end-of-day auto shutdown. To set the time, tap the up or down arrows, holding for a few seconds as the time changes. The auto shutdown can be temporarily disabled by tapping the Off button, but it is automatically enabled the next day.



REQUIRED TOOLS

- T1 Life Cycle Cost Analysis
- T2 Catalog of Courtroom Layouts for California Trial Courts
- T3 Integrated Network Architecture

T4 GRAPHICAL USER INTERFACE TEMPLATE

- T4.A Introduction
- T4.B Page Descriptions

- T5 In-Custody Interview Room Guidelines
- T6 Building Management System Guidelines

DRAFT

REQUIRED TOOLS

T5

IN-CUSTODY INTERVIEW ROOM GUIDELINES

SECTION	TOPIC	PAGE
T5.A	Acoustic Study	T5.2
T5.B	Observations and Measurement Results	T5.3
T5.C	Requirements	T5.3
T5.D	Speech Privacy	T5.5
T5.E	Sound Isolation	T5.5
T5.F	As-Built Dimensioned Drawing	T5.6
T5.G	Selective Performance Requirements for Interview Rooms Specification	T5.6

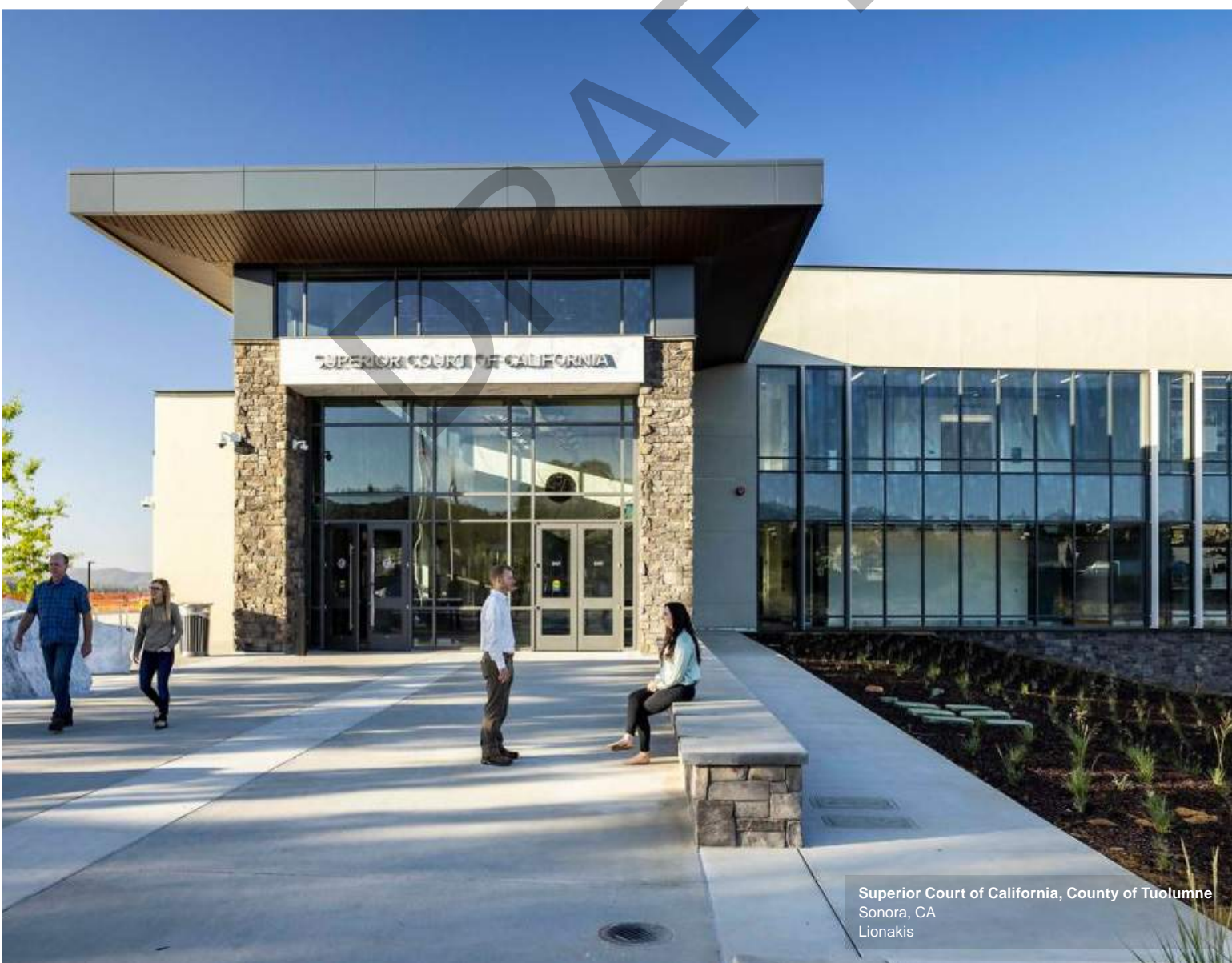

Superior Court of California, County of Tuolumne
Sonora, CA
Lionakis

ABBREVIATIONS

ASHRAE = American Society of Heating, Refrigerating and Air-Conditioning Engineers

ASTM = An international standards organization that develops and publishes voluntary consensus technical standards

NC = Noise Criteria: A single-number rating defined by ASHRAE that quantifies a steady-state noise

NIC = noise isolation class: A single-number rating defined in ASTM E336 that quantifies the ability of a partition to reduce airborne noise between adjacent enclosed spaces under field conditions

NRC = noise reduction coefficient: A number between 0 and 1 that represents how much an object hinders sound passing through it (with a higher number representing a greater sound barrier)

STC = sound transmission class: An integer rating used to indicate how well a building partition attenuates sound (with a higher rating indicating a greater sound barrier)

T5.A ACOUSTIC STUDY

To ensure confidentiality, care must be taken in the construction of in-custody interview rooms, also referred to as attorney-client interview rooms, to prevent sound transmission to outside those rooms. The in-custody interview rooms are composed of an attorney side and an in-custody side, separated by a partition and a transaction window, as described below. The Judicial Council Facilities Services office has noted that in-custody interview rooms in the Superior Court of Santa Clara County's Family Justice Center Courthouse in San Jose, California, have kept conversations between attorneys and their clients sufficiently contained within the constructed interview rooms. The following report has been put together to characterize the existing space and to recommend acoustic standards based on these rooms to inform the construction of future in-custody interview rooms.

1. Findings

The following is a summary of the findings of the existing conditions and the sound isolation assessment of a selected pair of in-custody interview rooms in the Family Justice Center Courthouse. Observations and measurements were focused on a fourth-floor pair of in-custody interview rooms. Architectural working drawings suggest similar construction at similar pairs of interview rooms on the second and third floors.

- a. In-custody interview room separation walls include windows with frame spacers to support unamplified conversation.
- b. The entry door at the attorney side of the interview room is fully gasketed, whereas the in-custody side of the room has head and jamb seals only; corresponding sound isolation between interview rooms and adjacent circulation spaces was measured as noise isolation class (NIC) 34 and NIC 21, respectively.
- c. Measured airborne sound isolation through the typical gypsum board wall on the attorney side of the interview rooms and the security wall on the in-custody side of the rooms was NIC 46 and NIC 34, respectively.
- d. Because of the column layout on the fourth floor, interview rooms are separated from adjacent attorney-client conference rooms and a courtroom by double-wall assemblies; measured airborne sound isolation was NIC 52 to 62 through these assemblies.
- e. HVAC (heating, ventilation, and air-conditioning) systems serving interview rooms consist of the following:
 - A supply duct path served by variable air volume (VAV) boxes that also serve adjacent spaces.
 - No ducted return air paths. Therefore, return air from the attorney side of the interview room appears to pass through the window frame to the in-custody side of the interview room, and return air then travels through the undercut door to the holding vestibule.
- f. Background noise levels, because of HVAC systems, were NC (Noise Criteria) 38 in the attorney side of the interview room and NC 27 in the in-custody side of the interview room.

2. Guidelines

Following is a summary of guidelines for future in-custody interview rooms:

- a. The transaction window between the attorney side and the in-custody side of interview rooms shall allow unamplified speech communication at normal conversational levels.

- b. Room acoustic treatments shall support speech intelligibility.
- c. Sound isolation and minimum background sound levels shall provide confidential speech privacy between interview rooms and adjacent spaces.
- d. HVAC systems shall support the intended use and maintain sound isolation.

T5.B OBSERVATIONS AND MEASUREMENT RESULTS

The Family Justice Center Courthouse has three pairs of in-custody interview rooms, one on the second, third, and fourth floors. Each pair of rooms is separated by a concrete masonry unit (CMU) wall that breaks the ceiling plane and extends to within 6" of the deck above. These walls include windows with frame spacers to support unamplified conversation.

The attorney side of the interview rooms is accessed from public circulation areas with fully gasketed doors and is separated from adjacent rooms by full-height metal stud walls. The in-custody side of the interview rooms is accessed from holding vestibules with partially gasketed doors and is separated from adjacent rooms by security walls constructed of mortar and steel. Table T5.1 summarizes additional design features.

Conditioned air serving the interview rooms is provided by ducted air-handling units with zoned VAV systems. Although the attorney and in-custody sides of the interview rooms are served by separate VAV boxes, the boxes are shared with other adjacent attorney and in-custody spaces. Each room includes one ducted supply air diffuser. Mechanical drawings indicate that neither room has a ducted return air path. Therefore, it appears that return air from the attorney side of the interview room travels through the conversation window to the in-custody side of the interview room; return air from both rooms travels through the undercut room door on the in-custody side to the holding vestibule.

When measurements were taken, the building was partially occupied and HVAC systems were operating as normal. Measurements quantified airborne sound isolation in terms of Noise Isolation Class between the in-custody interview rooms and adjacent spaces, as well as background noise levels caused by HVAC systems. Sound levels measured in the in-custody interview room were not adjusted to account for the effects of the room volume and furnishings. Figure T5.1 summarizes measured airborne sound isolation. Background HVAC noise was NC 38 in the attorney side of the interview room and NC 27 in the in-custody side of the interview room.

T5.C REQUIREMENTS

The requirements for interview rooms are based on observations and measurements of existing interview rooms at the Family Justice Center Courthouse and industry standard knowledge.

Requirements are also included in chapter 5, Court Set; chapter 8, In-Custody Defendant Receiving, Holding, and Transport; and chapter 19, Acoustical Criteria. Following is a summary of the requirements.

1. HVAC Noise

- Interview rooms: Background noise level of NC 30 or less so that it does not interfere with speech communication between interview rooms.
- Ducted supply and return air paths: Lined return air boots to support fully gasketed interview room doors. Undercutting the door for air return is not permitted. Note that this requirement is not followed in the application at the Family Justice Center Courthouse in that the in-custody interview room door is undercut to provide a return

REQUIRED TOOLS

- T1 Life Cycle Cost Analysis
- T2 Catalog of Courtroom Layouts for California Trial Courts
- T3 Integrated Network Architecture
- T4 Graphical User Interface Template

T5 IN-CUSTODY INTERVIEW ROOM GUIDELINES

- T5.A Acoustic Study
- T5.B Observations and Measurement Results
- T5.C Requirements
- T5.D Speech Privacy
- T5.E Sound Isolation
- T5.F As-Built Dimensioned Drawing
- T5.G Selective Performance Requirements for Interview Rooms Specification
- T6 Building Management System Guidelines

Table T5.1 Construction Elements and Finishes of In-Custody Interview Rooms

ROOM	FLOOR	CEILING	DOOR	WALLS
Attorney side of Interview Room 4C (427)	Carpet	Acoustical ceiling tile (USG Mars mineral fiber or equivalent product, NRC 0.75)	Metal door with head and jamb bulb gaskets; automatic drop bottom with threshold	<p>Typical: Full-height single metal-stud assemblies sealed to the underside of the deck above</p> <p>Corridor/circulation walls with three total layers of gypsum board and surrounding rooms with four</p> <p>Additional furred walls where structural columns exist, including on the fourth floor</p>
In-Custody side of Interview Room 4-IC (428)	Polished concrete	Detention-grade perforated metal	Metal door with full perimeter bulb seal and approximately 1" gap at the bottom	Typical: Steel-covered walls with mortar-filled corrugated metal interior composition

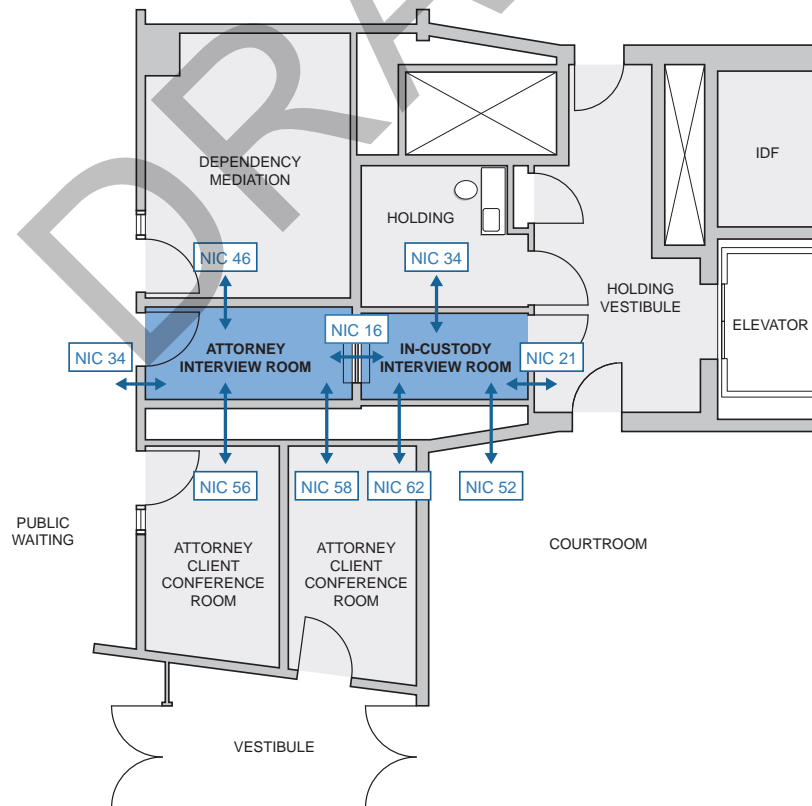

Figure T5.1 Airborne Sound Isolation Measurement

air path at that facility. Speech privacy is required at in-custody interview rooms, and the undercut may impede the privacy requirements. Hence, this variation will not be permitted in future projects.

2. Room Acoustics

- Attorney side of the interview rooms: Carpeted floor and sound-absorbing ceiling with minimum noise reduction coefficient (NRC) of 0.70 to support clear speech communication.
- In-custody side of the interview rooms: Hard-finish floor, and ceilings that are detention-grade perforated metal with a 1" thick sound-absorbing material above (minimum NRC 0.70).

T5.D SPEECH PRIVACY

Speech privacy is a function of the acoustic separation between two spaces, quantified in terms of sound transmission class (STC), and the background noise level in the receiving space, measured in terms of Noise Criteria (NC). For normal conversational levels, speech privacy is generally considered to be normal when the composite STC and NC is 70, and confidential when the composite is 80. For reference, *normal speech privacy* generally means the ability to comprehend an occasional word but not complete sentences, and *confidential speech privacy* generally implies that an occupant in the adjacent space may be aware that a conversation is taking place but would be unable to understand individual words.

Following are the requirements for sound isolation in in-custody interview rooms. The design team shall review adjacencies on a project-by-project basis to confirm that confidential speech privacy is achieved and upgrade wall and door assemblies, and/or background noise levels, as needed. If HVAC systems operate at varying fan speeds, electronic sound masking may be needed to maintain a constant background noise level in adjacent spaces.

T5.E SOUND ISOLATION

1. Wall Assemblies

- Attorney side of interview room to adjoining areas (unless otherwise noted): STC 50, using for instance a single metal stud with two layers of gypsum board on each side and batt insulation in stud cavities.
- Attorney side of interview room to public corridor or vestibule: STC 45, using for instance a single metal stud with two layers of gypsum board on one side and one layer on the opposite side and batt insulation in stud cavities.
- In-custody side of interview rooms to adjacent spaces: STC 40, using for instance grout-filled metal security wall assembly.

2. Doors

- Attorney side of interview room to public corridor: Laboratory-rated STC 43.
- Attorney side of interview room to secure vestibule or hallway: A minimum 3/4" solid-core wood door or hollow metal steel door with a full set of acoustical seals, including perimeter gasketing and an automatic door bottom.
- In-custody side of interview room: A minimum 3/4" solid-core wood door or hollow metal steel door with a full set of acoustical seals, including perimeter gasketing and an automatic door bottom. MegaMet Industries' MegaSCIF doors rated up to STC 52 and

REQUIRED TOOLS

- T1 Life Cycle Cost Analysis
- T2 Catalog of Courtroom Layouts for California Trial Courts
- T3 Integrated Network Architecture
- T4 Graphical User Interface Template

T5 IN-CUSTODY INTERVIEW ROOM GUIDELINES

- T5.A Acoustic Study
- T5.B Observations and Measurement Results
- T5.C Requirements
- T5.D Speech Privacy
- T5.E Sound Isolation
- T5.F As-Built Dimensioned Drawing
- T5.G Selective Performance Requirements for Interview Rooms Specification

- T6 Building Management System Guidelines

made of military-grade, 14-gauge stainless steel are available. If removal of the typical seals the manufacturer uses are a self-harm concern for the in-custody person, manufacturers offer custom doors that could minimize the chances of the seals being removed for this purpose.

3. Floors

- Attorney side of interview rooms: Carpeted floor and sound-absorbing ceiling to reduce unwanted echoes and increase speech intelligibility, with a minimum NRC of 0.70.
- In-custody side of interview rooms: Hard finish, with perforated metal ceilings with a 1" thick absorbing material above (minimum NRC 0.70).

4. Windows

The wall separating attorney and in-custody sides of the interview room is typically CMU or grout filled for security purposes. The design and construction shall allow for unamplified speech communication. Provide voice-around transaction windows that allow for natural voice transmission through the frame, as consistent with security requirements. Appropriate products shall be equivalent to Aluminum Voice Around Transaction Windows by Total Security Solutions. More specific requirements for windows in these interview rooms are listed below:

- Interview room windows: A glazed opening between the attorney and in-custody sides of the interview room that provides sufficient open areas in the frame to support unamplified conversation between the two sides, as consistent with security requirements.
- Attorney-side door windows: Integrated door windows provided by the manufacturer to meet the desired sound rating.
- In-custody-side door windows: Security windows as required.
- Sound-rated construction: Sealed perimeter walls, penetrating elements, outlet boxes, junction boxes, and low-voltage receptacles to maintain sound isolation.

T5.F AS-BUILT DIMENSIONED DRAWING

The as-built drawing of the Family Justice Center Courthouse may be used as a template for future in-custody interview rooms. The airborne sound isolation measurement drawing is shown in figure T5.2. Upon court request, a paper pass-through opening may be added below or on the side of the transaction window, as shown in figure T5.3.

T5.G SELECTIVE PERFORMANCE REQUIREMENTS FOR INTERVIEW ROOMS SPECIFICATION

1. General

1.1 Related Documents

- a. Drawings and general provisions of the construction contract, including General and Supplementary Conditions and other Division 01 Specification sections, apply to this section.
- b. The construction or renovation of in-custody interview rooms shall comply with the *California Trial Court Facilities Standards*, including but not limited to chapter 5, Court Set; chapter 8, In-Custody Defendant Receiving, Holding, and Transport; and chapter 19, Acoustical Criteria.

1.2 Summary

- a. This section includes general requirements and procedures for compliance with sound containment for in-custody interview rooms, as indicated in the drawings.
- b. This section also includes the Noise Criteria requirements for the in-custody interview room to ensure speech communication without noise interference.

1.3 Definitions

The definitions that follow explain the difference between several sound ratings used in the performance requirements outlined in this specification. They measure noise reduction, noise criteria, noise buildup within a space, and sound transmission between spaces. These factors are combined to achieve the desired sound performance of the space.

- a. **Noise Isolation Class**—A single-number rating, defined in ASTM E336, that quantifies the ability of a partition to reduce airborne noise between adjacent enclosed spaces under field conditions. The sound levels measured in the receive room are not adjusted to account for the effects of the room volume and furnishing. Higher NIC ratings correspond to improved airborne sound isolation.
- b. **Noise Criteria**—A single-number rating, defined by ASHRAE, that quantifies a steady-state noise. It is based on a family of curves that includes noise from 63 to 8,000 hertz (Hz). NC is typically used to rate the loudness of HVAC system noise in a room.
- c. **Sound Transmission Class**—The STC measures the sound transmission between spaces. A single-number rating is used to measure the assembly's barrier effect. A higher STC rating blocks more noise from transmitting through a partition. Loud speech can be understood through an STC 30 wall but should not be audible through an STC 60 wall. For instance, Fiberlite Technologies' cellulose insulation products have an STC rating of 44 to 68 depending on the wall construction. STC ratings do not assess the low-frequency sound transfer. They are based on performance with frequencies from 125 to 4,000 Hz (speech frequencies). The STC rating is a lab test that does not take into consideration weak points, penetrations, or flanking paths.
- d. **Noise Reduction Coefficient**—The NRC measures the buildup of noise within a space. A single-number index rating is used to measure the sound absorption of a material. Fiberlite's cellulose insulation products have an NRC rating from 0.75 to 0.82 depending on wall design, materials, and applied density of the product. Fiberlite's cellulose insulation products will absorb 75 to 82 percent of the sound that they come in contact with and will reflect 18 to 25 percent of the sound back into the space. However, NRC does not address a material's barrier effect. Nor does it give information as to how absorptive a material is in the low and high frequencies. NRC is only the average of the midfrequency sound absorption coefficients (250, 500, 1,000, and 2,000 Hz) rounded to the nearest 5 percent.

1.4 Interview Room Performance Requirements

- a. **HVAC noise:** All in-custody interview rooms shall have a background of NC 30 or less so that noise does not interfere with speech communications.
- b. **Room acoustics:** In-custody interview rooms shall include sound-absorbing elements with a minimum NRC of 0.70.

REQUIRED TOOLS

- T1 Life Cycle Cost Analysis
- T2 Catalog of Courtroom Layouts for California Trial Courts
- T3 Integrated Network Architecture
- T4 Graphical User Interface Template

T5 IN-CUSTODY INTERVIEW ROOM GUIDELINES

- T5.A Acoustic Study
- T5.B Observations and Measurement Results
- T5.C Requirements
- T5.D Speech Privacy
- T5.E Sound Isolation
- T5.F As-Built Dimensioned Drawing
- T5.G Selective Performance Requirements for Interview Rooms Specification

- T6 Building Management System Guidelines

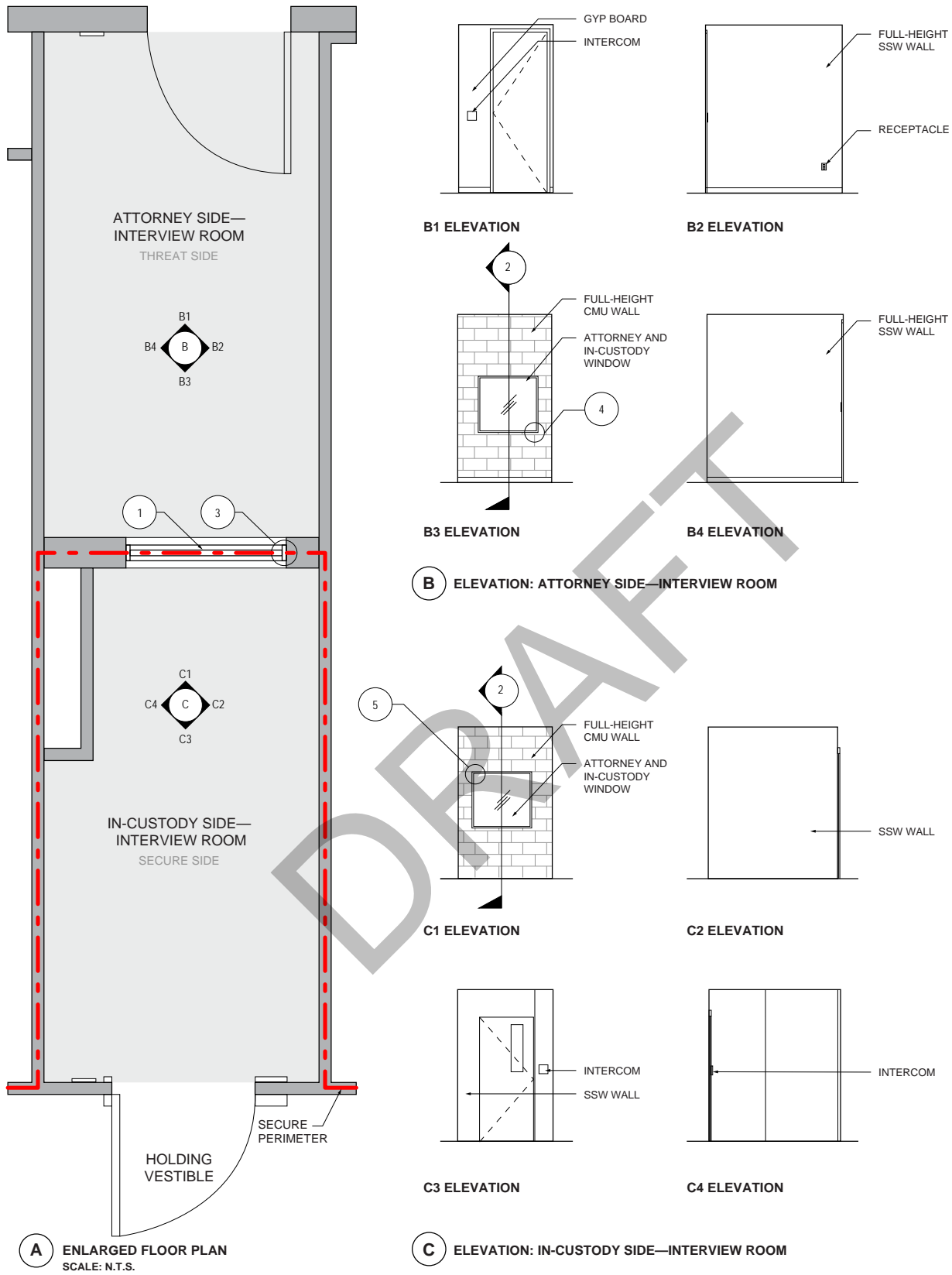

SSW = Steel Strong-Wall.

Figure T5.2 As-Built Drawing (not to scale)

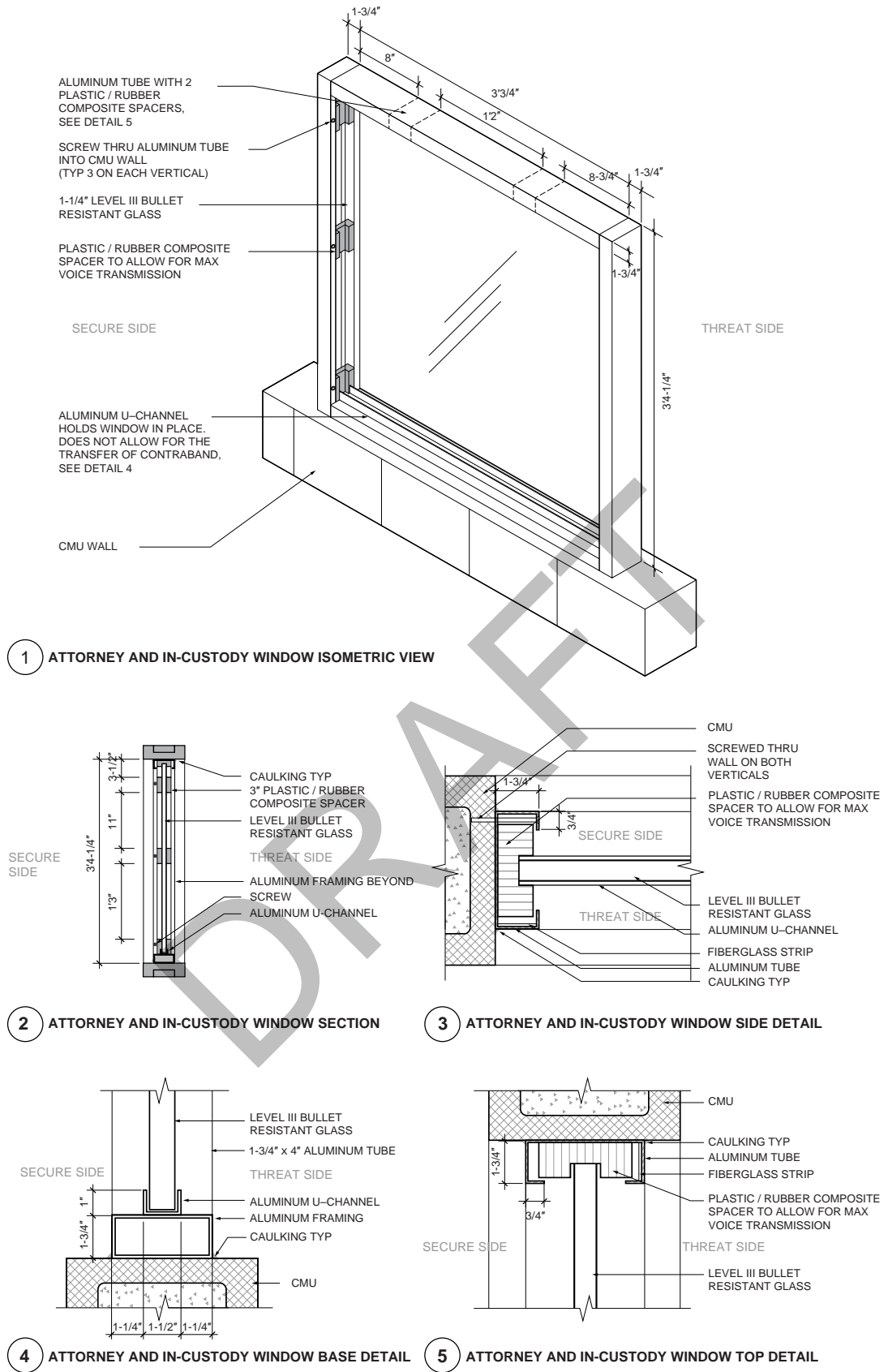

Figure T5.2 As-Built Drawing (not to scale) continued

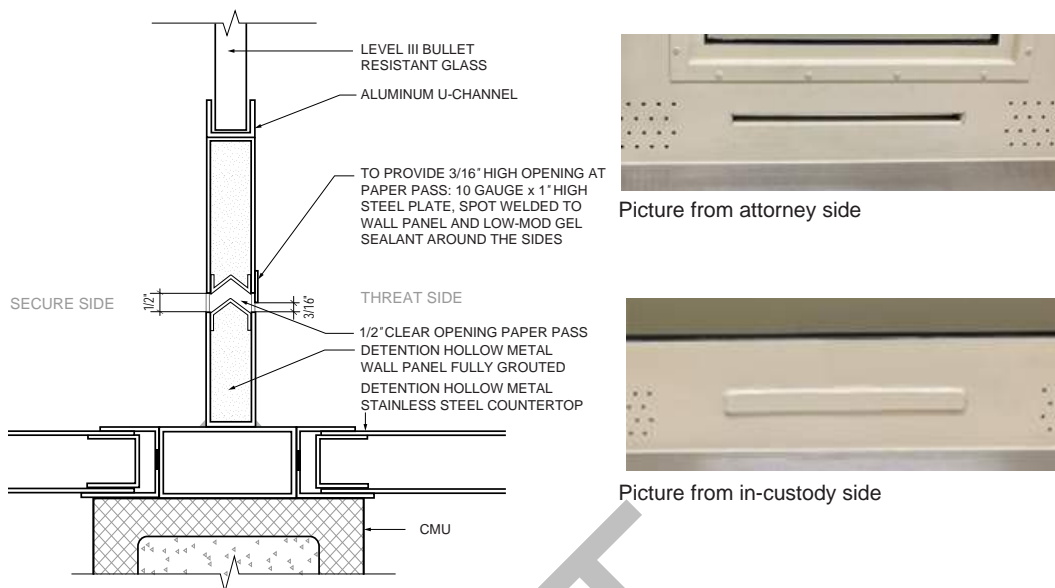

Figure T5.3 Paper pass-through (not to scale)

- c. Sound isolation: Transmission class will vary depending on adjacent spaces and room occupancy as follows:
 1. Attorney side of interview rooms to adjacent areas shall have an STC 50 rating.
 2. Attorney side of interview rooms to secure vestibule or hallway shall have an STC 45 rating.
 3. In-custody side of interview room to adjacent spaces shall have an STC 40 rating.
- d. Doors transmission: Doors shall be laboratory tested and rated for STC 43.
- e. Window speech passage: Window sound ratings and open area to support unamplified conversation between two rooms shall be certified by manufacturer and tested after installation to ensure that room will meet the sound criteria.
 1. Through the design, manufacturing techniques, and material application, the Total Security Solutions (TSS) Natural Voice Rail transaction window shall be of the “non-ricochet” type. This design is intended to permit the capture and retention of an attacking projectile, lessening the potential of a random injury or lateral penetration. This design shall employ a spacer within the frame to allow for natural sound transmission. Each transaction position may have a stainless steel dip tray at the court’s request. Components must be manufactured in strict accordance with the specifications, design, and details. All vision panels shall be cut to size, with all exposed edges polished. Necessary holes shall be predrilled and tapped where required. Stainless steel assembly screws and acrylic spacers shall be provided. Frame and channel shall be provided. Anchor screws shall be provided by the installer.

No field alterations to the construction of the units fabricated under the acceptable standards shall be allowed unless approved by the manufacturer and the architect. Standard manufacturing tolerances shall be $\pm 1/16''$.

2. Materials shall meet or exceed Underwriters Laboratories' UL 752 requirements.

1.5 Design Meetings

- a. Predesign conference: Conduct conference at the project site to review in-custody interview room requirements and action plans for compliance with these requirements.
- b. After preparation of proposed sound performance measures, conduct a review meeting.

1.6 Administrative Requirements

- a. Respond to questions and requests from the Judicial Council about proposed sound compliance measures.
- b. Submit documentation to the Judicial Council project manager.

1.7 Action Submittals

- a. Provide sound performance calculations for each compliance measure listed in paragraph 1.4.
- b. Provide shop drawings of the proposed assemblies included in the compliance measures—including HVAC ductwork, wall and ceiling assemblies, floor attenuation, door types and proposed seals and gaskets, window types, and sound rating—to provide unamplified conversation.
- c. Provide detail of sound-rated construction—including seals around perimeter walls and treatment of penetrating elements, including air terminal devices, outlet boxes, junction boxes, and receptacles, as required—to maintain sound isolation.

2. Products and Materials

2.1 General

- a. Provide materials per approved shop drawings, product data submittals, and proposed room assemblies for ceilings, walls, and floor.
- b. All materials shall be new and shall meet the Judicial Council requirements.
- c. Materials shall form a passive system with spacers, sound insulation, gaskets, and seals to meet the sound performance requirements.

2.2 Wall Assemblies

- a. In the attorney side of interview rooms, build walls with metal studs with sound-absorbing fiberglass insulation in cavity and faced with two layers of drywall on each side. QuietRock or an equivalent product may be used on one layer facing the interview room side, if necessary, to meet the required sound rating.
- b. The walls for the in-custody side of interview rooms shall be constructed of grout-filled, metal security wall assembly and shall meet the Sound Transmission Class specified.

REQUIRED TOOLS

- T1 Life Cycle Cost Analysis
- T2 Catalog of Courtroom Layouts for California Trial Courts
- T3 Integrated Network Architecture
- T4 Graphical User Interface Template

T5 IN-CUSTODY INTERVIEW ROOM GUIDELINES

- T5.A Acoustic Study
- T5.B Observations and Measurement Results
- T5.C Requirements
- T5.D Speech Privacy
- T5.E Sound Isolation
- T5.F As-Built Dimensioned Drawing
- T5.G Selective Performance Requirements for Interview Rooms Specification

- T6 Building Management System Guidelines

2.3 Floor Assemblies

- a. Carpet or rubber sound-absorbing materials may be used in the attorney side of interview rooms to meet the required Sound Transmission Class.
- b. A hard-finished floor is required for the in-custody side of the interview rooms. Other measures shall be applied to wall assembly and ceiling to meet the required Sound Transmission Class.

2.4 Ceilings

- a. Drywall or acoustical ceiling with sound control measures for all penetrating elements shall be used in the attorney side of the interview rooms.
- b. The in-custody side of the interview rooms shall include detention-grade perforated metal ceiling lined above with 1" minimum of sound-absorbing material as required to meet STC requirements.

2.5 Doors

- a. Doors shall be a minimum 3/4" solid wood core or hollow metal steel.
- b. Doors shall have a full set of acoustical seals, including a perimeter gasket.
- c. Doors shall have an automatic seal door bottom.

2.6 Windows

- a. General Requirements
 1. All windows shall meet the Judicial Council security requirements.
 2. In-custody-side door windows shall be high-security rated to prevent breakage.
 3. All windows shall meet the room-specified sound rating.
 4. The glazed opening between the attorney and in-custody sides of interview rooms must provide sufficient free (open) area to support unamplified conversation between the two rooms without compromising the security requirements.
 5. Integrated door windows shall be certified by the manufacturer to provide the desired sound rating.
- b. Window Products
 1. Product shall be a TSS Natural Voice Rails transaction window or approved equal.
 2. Window system shall consist of a custom prefabricated bullet-resistant glazing section with secure air passage through frames, with black foam and wood spacers as required for natural voice transmission.
 3. It shall include a frame with optional plastic laminate shelf and optional recessed transaction tray. The shelf and transaction tray may be provided if requested by the court.
 4. All accessories for installation shall be included.
 5. Available frame selections are aluminum, steel, or stainless steel, but see item f below.

6. Product size of TSS Natural Voice Rail transaction window shall be a recommended width not to exceed 36" and height not to exceed 48".
- c. Bullet-Resisting Glazing Material Options
 1. Bullet Resistant Level 1: 3/4" LP 750 laminated, 1/4" uncoated acrylic, and GCP (glass-clad polycarbonate) 750
 2. Bullet Resistant Level 2: 1" LP 1000 laminated, 3/8" uncoated acrylic, and TSS 002 L/S
 3. Bullet Resistant Level 3: 1/4" LP 1250 laminated and TSS 003 L/S
 4. Bullet Resistant Levels 4–8: TSS 004 L/S through TSS 008 L/S
 - d. Optional Transaction Tray
 1. Brushed stainless steel counter, mounted or recessed, is optional.
 2. Transaction tray shall be 18-gauge stainless steel, #4 finish, 16" × 10" from the outside edge of flanges with a clear opening.
 - e. Optional Shelf
 1. Provide a 1-1/2" thick shelf with an optional recessed transaction tray, if requested by the court.
 2. The shelf shall be full width of window, 18" deep, centered under the glazing, and covered with a black high-pressure laminate, with an optional stainless steel 18-gauge #4 finish.
 - f. Recommended Frame Material: Aluminum
 1. Frame shall be anodized aluminum (optional 18-gauge primed or stainless steel, as specified). The bottom of the glazing shall be capped with corresponding material on the frame (i.e., stainless steel on stainless steel).
 2. Aluminum sections shall be manufactured in accordance with ASTM B209, extruded aluminum alloy 6063 T5 anodized or powder-coated finish to match the existing décor and be free of sharp edges or burrs when in place.
 3. Glazing channel shall be a U-channel specifically designed for securing transparencies tightly in place. Angles and stops are acceptable only for top attachment.

2.7 HVAC

- a. The HVAC system shall include ducted supply air and return air ducts.
- b. Supply air shall be ducted to a VAV box and/or to main air distribution duct. It shall not be connected to another room distribution branch where sound transmission between rooms could occur.
- c. Return air ducts shall include a lined return air box before connecting to the return air fan.
- d. Undercutting the door for air return is not permitted. Interview room doors shall include an automatic basket.

REQUIRED TOOLS

- T1 Life Cycle Cost Analysis
- T2 Catalog of Courtroom Layouts for California Trial Courts
- T3 Integrated Network Architecture
- T4 Graphical User Interface Template

T5 IN-CUSTODY INTERVIEW ROOM GUIDELINES

- T5.A Acoustic Study
- T5.B Observations and Measurement Results
- T5.C Requirements
- T5.D Speech Privacy
- T5.E Sound Isolation
- T5.F As-Built Dimensioned Drawing
- T5.G Selective Performance Requirements for Interview Rooms Specification

- T6 Building Management System Guidelines

DRAFT

REQUIRED TOOLS

T6

BUILDING MANAGEMENT SYSTEM GUIDELINES

SECTION	TOPIC	PAGE
T6.A	General Requirements.....	T6.2
T6.B	General Pneumatic Control Requirements.....	T6.5
T6.C	General Design Requirements.....	T6.6
T6.D	System Requirements.....	T6.8

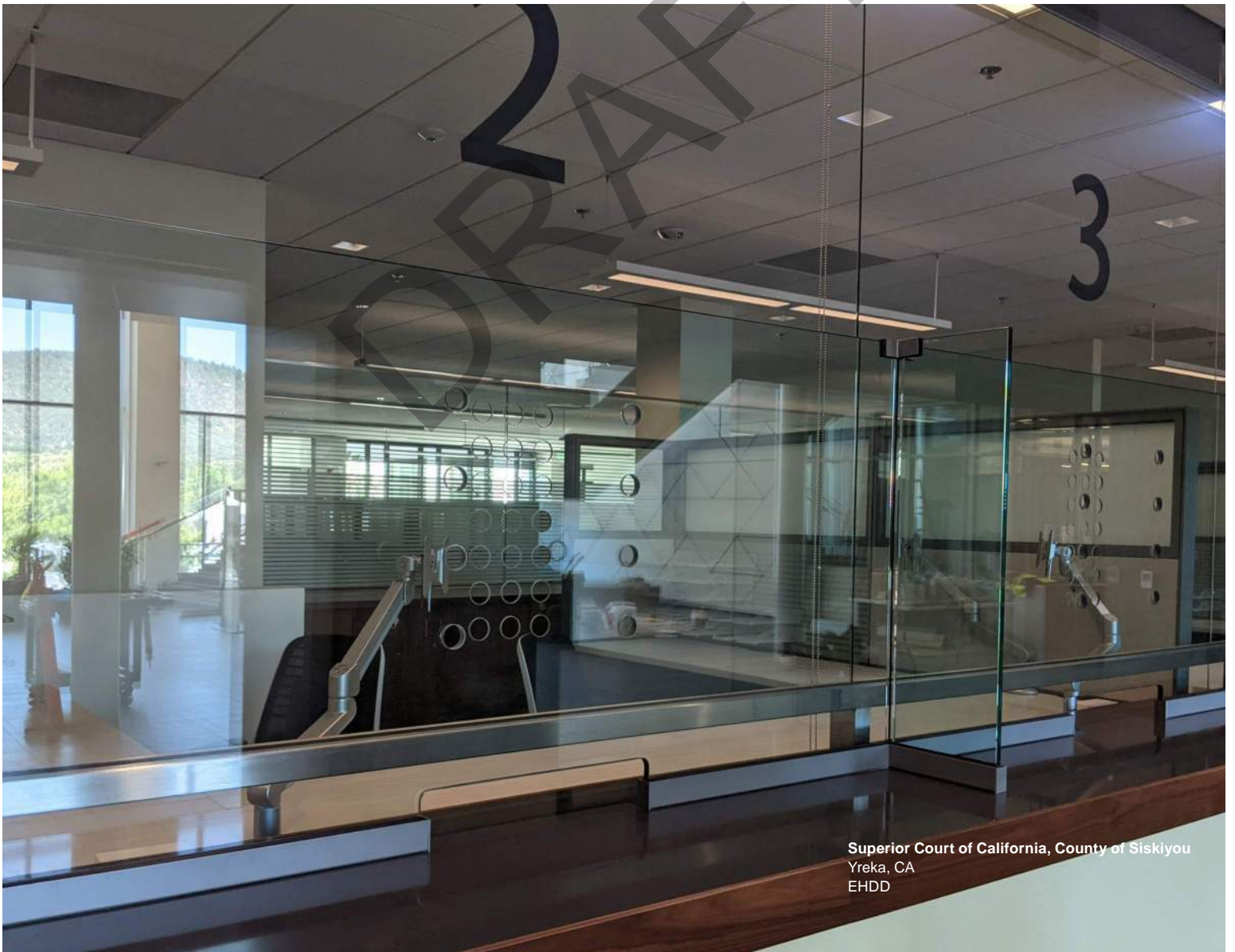

ABBREVIATIONS

ANSI = American National Standards Institute

ASC = application-specific controller

ASHRAE = American Society of Heating, Refrigerating and Air-Conditioning Engineers

BMS = building management system

BACnet = Building Automation and Control Network (ANSI/ASHRAE Standard 135)

BMA = BACnet Manufacturer's Association

BTL = BACnet Testing Laboratories (recognized, independent third-party laboratory certified to test products for compliance to BACnet standards)

BTL Mark = seal affixed to product certifying that it has been tested by a recognized BTL and found to conform to BACnet standards

DCP = distributed control panel

REST API = representational state transfer application programming interface

HTML = hypertext markup language

LAN = local area network

NEMA = National Electric Manufacturers Association

OIW = operator interface workstation

This section provides building management system (BMS) guidelines for Judicial Council projects.

T6.A GENERAL REQUIREMENTS

- a. All BMS designs shall incorporate and conform to these requirements.
- b. The BMS shall consist of the Tridium Niagara 4 platform to create smart-device applications. The system shall support an encrypted REST API, which allows for secure third-party custom applications and interfaces. The system shall be compliant with and support the HTML5 framework.
- c. Submittal requirements include the following:
 - Riser diagram
 - Standard for naming components
 - Design drawings for control panels, including wiring design diagram
 - Sequence of operation (to be developed in a collaborative effort with the Judicial Council)
 - Detailed network architecture diagram showing internet and/or active port connections
 - Detailed drawings showing cable pathways
 - Drawings showing all fire-rated walls and required fire-rated assemblies through rated walls
- d. All BACnet equipment and software supplied for Judicial Council projects shall be supported by a manufacturer-supplied protocol implementation conformance statement (PICS) certifying that the device complies with the specified BACnet requirements.
 - At a minimum, each BACnet PICS shall convey the following information:
 - Basic information identifying the vendor and describing the BACnet device.
 - The BACnet Interoperability Building Blocks supported by the field device.
 - The standardized BACnet device profile to which the device conforms.
 - All nonstandard application services that are supported, along with an indication for each service of whether the device can initiate the service request, respond to a service request, or both.
 - A list of all standard and proprietary object types that are supported.
 - For each object type supported:
 - i. Any optional properties that are supported;
 - ii. Which properties can be written-to use BACnet services;
 - iii. Whether the objects can be dynamically created or deleted using BACnet services; and
 - iv. Any restrictions on the range of data values for properties.
 - The data link layer options supported, both real and virtual.
 - Whether segmented requests are supported.
 - Whether segmented responses are supported.

- All products shall have a BTL Mark certifying that the product was independently tested by a third-party testing facility and complies with BACnet conformance requirements.
 - All BACnet products shall come with a full warranty for a minimum period of two years after system acceptance.
- e. Design specifications for BMS installations shall provide detailed specifications for all components of the BMS including equipment, field devices, wire/cable, conduit, pneumatic tubing, mounts, terminations, and the like.
- f. The BMS designer shall fully coordinate BMS design requirements with the other project design team parties (where applicable). The BMS designer shall coordinate field panel mounting locations, intended DCP/ASC locations, power supply requirements, communications outlet requirements, and the like.
- g. All new BMS installations shall be integrated and include all associated graphics. No exceptions.
- h. The following are general installation guidelines for BMS installations:
- All equipment and materials furnished shall be new.
 - All equipment and materials shall be UL listed. All temperature control panels (TCPs) shall be a UL-listed enclosure and built by a UL-listed panel shop. Equipment and components shall be labeled accordingly.
 - All similar components (e.g., temperature sensors, differential pressure transducers, current transformer/relay combinations, signal transmitters) in a BMS installation shall be provided by the same manufacturer.
 - Components shall be provided that are suitable for the intended application. Components shall be capable of maintained operation in the applicable environmental conditions and shall be capable of operation in contact with the controlled/monitored medium.
 - Except for field-mounted instrumentation and devices, all BMS components shall be installed in field panels (TCPs). Panels and enclosures shall meet, at a minimum, the following requirements:
 - Painted steel panels with hinged locking door. All panels shall be keyed to a standard key.
 - Ventilated to prevent excessive heat buildup, where excessive heat buildup is expected.
 - Field cabling terminated on terminal stripes. Cable within enclosures shall be installed in cable trays with snap-on covers.
 - Internal components installed to allow easy access for diagnostics, maintenance, removal, or replacement.
 - Panel or enclosure suitably rated for the environment in which it is to be installed. Exterior enclosures shall be, at a minimum, NEMA-4 rated.
 - UL listed and registered.
 - Panels and enclosures shall only be located within mechanical rooms or at approved locations. Panel locations shall be coordinated during design with a Judicial Council representative and shall be identified on project design drawings. For new construction

REQUIRED TOOLS

- T1 Life Cycle Cost Analysis
- T2 Catalog of Courtroom Layouts for California Trial Courts
- T3 Integrated Network Architecture
- T4 Graphical User Interface Template
- T5 In-Custody Interview Room Guidelines

T6 BUILDING MANAGEMENT SYSTEM GUIDELINES

- T6.A General Requirements
- T6.B General Pneumatic Control Requirements
- T6.C General Design Requirements
- T6.D System Requirements

ABBREVIATIONS (CONT.)

PICS = protocol implementation conformance statement: All devices conforming to the BACnet protocol shall have a documented statement (PICS) that identifies all the portions of BACnet that are implemented in the device

TCP/IP = Transmission Control Protocol / Internet Protocol

UC = unitary controller

VPN = virtual private network

projects, the BMS panel locations shall be identified in the project mechanical design drawings. For retrofit applications, the BMS panel locations shall be identified on building floor plan drawings, to be included in the project documents.

- All components of the BMS shall be identification tagged. Identification tags shall be plastic laminated “luggage-style” tags securely fastened to the end device. Tags shall be of a minimum size of 3.15” × 1” engraved with 0.5” bold lettering. Identification tags shall be provided for, at a minimum, the following:
 - Sensors
 - Transmitters
 - BMS controlled valve and damper actuators
 - End devices
 - Distributed control panels (DCPs)
 - BACnet Advanced Application Controllers (B-AACs)
 - BACnet Application Specific Controllers (B-ASCs)
 - Field panels
- All BMS wire, cable, and pneumatic-control tubing shall be identification tagged. Wire/cable shall be identification tagged at every termination location. Wire/cable and tubing terminating at DCPs or ASCs shall be tagged with the DCP/ASC controller termination number. Wire/cable and tubing terminating at field devices shall be tagged with both the DCP/ASC number and the DCP/ASC termination number. At any splices or terminal strips between the field device and DCP/ASC, the wiring shall be tagged on both sides of the termination point the same as for a field device termination.
- All BMS field panel and DCP mounting locations shall be provided with 120 VAC power supply sources. The selection of normal power supply or standby power supply facilities shall be based on project and application-specific requirements. (For power requirements, see chapter 15, Electrical Criteria.) In general, however, BMS DCPs/ASCs (and associated network interface equipment) monitoring designated building-critical alarm points shall be provided with standby power supplies. The DCP/ASC at which the building-critical alarms are terminated shall be designated at the tie-in panel for the building. Where no standby power is available in the building, the tie-in panel shall be provided with uninterruptible power supply equipment. The BMS tie-in panel is required to remain operational in the event of loss of normal power supply to the building. In the event of a power supply failure, the tie-in panel shall continue to operate for 30 minutes and shall provide alarm annunciation, monitoring, and control of connected systems/devices from the ASC. The electrical power supply circuit shall be clearly labeled at the electrical distribution panel and at the BMS field panel location. As-built documentation shall detail power supply circuit source panels and termination locations.
- All installations shall be provided to readily allow access for maintenance.
- Submittals shall be provided on a memory key (USB flash drive) to the Judicial Council upon project completion.
- Room sensors in public spaces shall be supplied without displays or keypads. BMS designers shall coordinate with the Judicial Council for specific project requirements.

- Software requirements include the following:
 - Trending logs
 - Schedules
 - Storage requirements
 - Event logging
 - Alarm generation and processing
 - Programming
 - Report creation

T6.B GENERAL PNEUMATIC CONTROL REQUIREMENTS

The following are minimum requirements related to BMS pneumatic controls installations. Note that this section is only applicable to existing installations, not new installations.

- a. All installations shall be in accordance with applicable codes, statutes, and ordinances. All pneumatic-control air tubing shall be specified to comply with minimum operating temperatures and pressures.
- b. Pneumatic-control air lines installed within mechanical rooms may be copper tubing and/or polyethylene-type tubing, shall be rated for the installation application, and shall be suitably labeled.
- c. Pneumatic-control air tubing may be installed in ceiling spaces without conduit where code permits. Tubing installed in ceiling spaces without conduit shall be suitably rated and labeled. Tubing shall be securely supported and installed in a neat and workmanlike manner following building lines. Sleeves shall be provided for all tubing that penetrates wall partitions, concrete slabs, or rated partitions.
- d. In retrofit applications, three-way switch over valves shall be provided on existing pneumatic-control air lines to controlled devices for switching between new BMS control and existing pneumatic-control facilities. Existing pneumatic-control facilities shall remain installed and operational until the work on the BMS is complete and demonstrated to the Judicial Council. The BMS designer shall specify the requirement for the removal of redundant pneumatic-control components.
- e. BMS pneumatic-control air facilities shall meet the following minimum requirements:
 - Tubing shall be installed with suitable support using standard fittings and conditions and shall run parallel to building lines.
 - Tubing shall be installed with protection from ambient and outdoor temperature effects. Where required, tubing shall be installed with stand-offs, insulation, and the like.
 - Multiple tubing runs shall be installed in parallel runs and shall be suitably supported and tie-wrapped in tube bundles.
 - Pneumatic-control air tubing shall be terminated with standard fittings at panel-mounted devices or at pneumatic bulkhead fittings within panels. Field device connections may be run in steel protective spring or BX conduit (armored cable).
 - Rubber grommets shall be provided wherever control tubing passes through ducts or plenum walls.

REQUIRED TOOLS

- T1 Life Cycle Cost Analysis
- T2 Catalog of Courtroom Layouts for California Trial Courts
- T3 Integrated Network Architecture
- T4 Graphical User Interface Template
- T5 In-Custody Interview Room Guidelines

T6 BUILDING MANAGEMENT SYSTEM GUIDELINES

- T6.A General Requirements
- T6.B General Pneumatic Control Requirements
- T6.C General Design Requirements
- T6.D System Requirements

- A pressure gauge shall be provided at each tapping off of the main air line. If a pressure-reducing valve is required, then the gauge shall be positioned after the valve.
 - BMS pneumatic-control output lines to each controlled device shall be provided with two pressure gauges. The gauges shall be mounted at the DCP/ASC control output location and at the input to the control actuator.
- f. Pilot positioners shall be provided for all BMS-controlled pneumatic actuators that are controlled in sequence (e.g., mixed air dampers, 1/3–2/3 steam valves).
- g. In-line desiccant filters shall be provided on all main pneumatic-control air lines supplying DCPs and ASCs with BMS pneumatic-control outputs. The in-line desiccant filters shall be provided in addition to the building main's pneumatic-control air dryer/filter facilities.
- h. In a BMS retrofit application, the existing building pneumatic-control air facilities shall be inspected during the design phase to ensure that air dryer and filter equipment are installed and operational. If the building is not equipped with satisfactory pneumatic-control air filtration and dryer equipment, this equipment shall be installed as part of the BMS installation project. The following are minimum pneumatic-control air dryer and filtration equipment requirements:
- Two refrigerant-type air dryers shall be provided in a duty/standby configuration.
 - Installation shall be in discharge-air line from controls air-compressor set and storage tank.
 - Installation shall include:
 - Air inlet and outlet pressure gauges and automatic moisture removal trap;
 - Three-way valve manifold and piped in a duty/standby configuration to allow the operation of one dryer at a time, with the second (standby) dryer valve switched off; and
 - Dual air filtration to remove moisture, oil, and particulate matter from the controls air supply and shall include a BMS-monitored low-pressure alarm indication device. The low-pressure alarm condition shall be annunciated at the BMS front end.

T6.C GENERAL DESIGN REQUIREMENTS

- a. The BMS shall incorporate hardware and software resources sufficient to meet the functional requirements of the specifications. The facility local area network and device-level network shall be based on industry-standard open platforms and protocols and utilize commonly available operation, management, and application software. Systems shall utilize BACnet IP via Category 6A cable. All software packages and databases shall be licensed to the Judicial Council of California to allow unrestricted maintenance and operation of the BMS. The contractor shall include all items not specifically itemized in these requirements and guidelines that are necessary to implement, maintain, and operate the system in compliance with the functional intent of the specifications.
- b. All BMSs shall conform to the most recent revision of the ANSI/ASHRAE Standard 135, including all issued addenda, at a minimum at the management data communication network level as defined within these guidelines. All BMSs shall also be native BACnet compliant at the automation data communication network level.
- c. When applicable, the BMS designer shall use sequences of operation in compliance with the most recent version of ASHRAE Guideline 36 (High-Performance Sequences of Operation for HVAC Systems).

- d. BMS installations shall allow for centralized operator interface for monitoring and supervisory control of the individual building BMS.
- e. BMS installations shall use standardized iconography as part of the graphical user interface. The icons shall be based on the type of equipment and must be approved by the Judicial Council at the time of system design.
- f. All BMS installations shall have a network data server computer, where specified, with associated BMS manufacturer application software installed onsite and running. The network data server computer shall be provided by the associated BMS contractor to the Judicial Council, complete with all manufacturer-specific BMS operator interface software for programming, database development, data archiving and storage, and controller program backup.
- g. BMS installations shall be provided that incorporate BMS equipment and network facilities in compliance with the requirements identified in these guidelines. The BMS network segments shall be dedicated to the BMS. The BMS designer shall specify detailed BMS equipment requirements and BMS network architecture requirements in the BMS design specifications. BMS equipment and data communication network specifications shall incorporate good BMS engineering, design, and application practices and shall incorporate these BMS design guideline requirements. Network latencies must match or respond faster than the fastest controller device node on the BMS network.
- h. The DCPs shall be designed around open and secure communications standards using HTML5 (or the current major version of the HTML standard) web technology. DCPs shall have the capability to communicate via multiple industry open protocols running over building network infrastructures and computer networks. At a minimum, the DCP shall be able to communicate directly with BACnet, LonWorks, and Modbus devices and controllers, using TCP/IP.
- i. It shall be possible to access the BMS remotely. With a proper username and password, a remote operator shall be able to monitor or control BMS functions via a graphical user interface. The remote access shall be through a standard internet browser. The system shall be capable of supporting an unlimited number of remote clients. A VPN gateway shall be provided for security protection.
- j. Browser-based access: A remote/local user, with a proper username and password, shall have access to monitor or control the BMS functions via a graphical user interface. Native internet browser-based user interfaces must be HTML5 compliant and not require plug-ins (thin clients). The system shall be capable of supporting an unlimited number of clients using a standard Web browser.
- k. BMS online editing is necessary for all controllers that serve critical equipment (as determined by the project team) that cannot be shut down without a maintenance shutdown notice.
- l. BMS installations in Judicial Council buildings shall incorporate the following minimum requirements:
 - Equipment shall be approved components as manufactured by one of the Judicial Council–approved BMS manufacturers and shall follow these BMS Design Guidelines.
 - Management- and automation-level communication LANs shall be provided to ensure the following:
 - The failure of a DCP shall not affect the operation of other operating DCPs. Unitary controllers (UCs) supervised by the failed DCP shall continue to function and shall control associated equipment according to specified failure routines. Where information in the failed DCP is used by other DCPs, UCs, buildings, routines, and

REQUIRED TOOLS

- T1 Life Cycle Cost Analysis
- T2 Catalog of Courtroom Layouts for California Trial Courts
- T3 Integrated Network Architecture
- T4 Graphical User Interface Template
- T5 In-Custody Interview Room Guidelines

T6 BUILDING MANAGEMENT SYSTEM GUIDELINES

- T6.A General Requirements
- T6.B General Pneumatic Control Requirements
- T6.C General Design Requirements
- T6.D System Requirements

REFERENCES

Johnson Controls

www.johnsoncontrols.com/buildings/building-management

Honeywell

<https://buildings.honeywell.com/us/en/brands/our-brands/bms>

Schneider Electric

www.se.com/us/en/product-category/1200-building-management

Distech Controls

www.distech-controls.com/products/family/building-automation-system-na

the like, the nonavailability of the information shall be alarmed, and alternate control strategies shall be automatically initiated.

- The failure of a UC shall not affect the operation of another operating UC or DCP.
 - All BMS monitored and controlled points associated with an individual HVAC system or equipment shall be terminated in the same UC or DCP. It is not acceptable for BMS monitored and controlled points associated with an individual system to be terminated at separate distributed DCPs or UCs.
 - All required logic programming and point database facilities associated with an individual building system shall reside in the same UC or DCP to which the system input/output points are terminated. It is unacceptable for logic programming and database facilities required for BMS monitoring and control of a building system to reside in a DCP or UC other than the one in which the system input/output points are terminated.
 - UCs controlling space terminal units (e.g., variable-air-volume terminal units, fan-powered terminal units) shall reside on the same automation LAN as the UC that is controlling the associated air-handling unit. If an air-handling unit is controlled directly by a DCP, the UC's controlling space terminal units shall be supervised by that DCP.
 - All BMS designs and installations shall incorporate and interface with lighting control systems, as applicable.
 - The sequence of operations shall be provided by the system designer to the Judicial Council before installation, as part of the submittal process.
 - Hardware, firmware, and client software upgrades shall be performed only if they enhance specific features applicable to the existing BMS environment, security, or system architecture.
- m. In existing facilities with standalone internet connections, the following shall apply:
- The BMS installation shall include software, firmware, and a firewall to ensure network protection.
 - The installer shall be responsible for generating the required IP addresses for all BMS devices. This information will be provided as part of the closeout documentation.
- n. In existing facilities connected to the court's network, the following shall apply:
- Coordination with court IT staff shall be facilitated through the Judicial Council's Low-Voltage Engineering Specialist on the Quality Assurance team.
 - The installer shall identify the active port connections needed for the system
 - The Engineering Specialist (Quality Assurance) shall request the court to create a virtual local area network (VLAN) for the BMS.
 - The installer shall generate a series of IP addresses based off the VLAN information provided by the court.

T6.D SYSTEM REQUIREMENTS

- a. Acceptable manufacturers include the following:
- Johnson Controls, Inc.
 - Honeywell

- Schneider Electric
 - Distech Controls
 - An approved equal
- b. BMS installations shall be provided by BMS contractors who meet the following requirements:
- Have been in operation in the BMS industry for a minimum of 10 years.
 - Employ qualified staff in the state of California capable of undertaking a complete BMS installation project and of providing routine and emergency maintenance on all elements of the BMS.
 - Have successful project experience on similar projects for a minimum period of five years.
 - Have service and support available 24 hours per day, seven days per week (suppliers only).
 - Have access to local suppliers of BMS components with a maximum delivery period of 24 hours.
- c. All BMS DCPs, UCs, OIWs, where applicable, and other BMS manufacturer-specific equipment within a building shall be manufactured by the same manufacturer. All HVAC and building services monitoring and controls shall be provided by BMS facilities from one of the approved BMS manufacturers. In applications where HVAC system controls within an existing building are being retrofitted and BMS facilities of any of the approved BMS manufacturers exist within the building, BMS facilities shall be provided by the manufacturer of the BMS equipment already installed. The retrofitted BMS installation shall be provided to interconnect the new renovation work into the existing building and campus BMS facilities.
- d. BMS direct digital controllers shall be products manufactured by a company that is an active corporate member of BACnet International.
- e. All BMS systems shall be fully demonstrated and operational, satisfy the Judicial Council, and be approved by Judicial Council Facilities Services before being considered an approved product or equal.
- f. The maximum allowed distance from the local field office of the system provider to the project site shall be no more than 75 miles.

REQUIRED TOOLS

T1	Life Cycle Cost Analysis
T2	Catalog of Courtroom Layouts for California Trial Courts
T3	Integrated Network Architecture
T4	Graphical User Interface Template
T5	In-Custody Interview Room Guidelines
T6	BUILDING MANAGEMENT SYSTEM GUIDELINES
T6.A	General Requirements
T6.B	General Pneumatic Control Requirements
T6.C	General Design Requirements
T6.D	System Requirements

DRAFT

APPENDIXES

Codes and Standards

List of Abbreviations

Index

Acknowledgments

DRAFT

APPENDIXES

CODES AND STANDARDS

DRAFT

The construction and modification of buildings using the *Facilities Standards* shall comply with the following codes, standards, and guidelines, and any other applicable nationally recognized code, standard, or guideline. The latest adopted code edition, standard, or guideline shall be used, regardless of dates shown in this document. If a triennial update of a code is due to occur after beginning of schematic design and before submission for plan check, the applicable code edition shall be determined after discussions with the authorities having jurisdiction. This list is not intended to limit the use of other reference documents.

A

Air Movement and Control Association Inc. (AMCA)

- AMCA 300: Reverberant Room Method for Sound Testing of Fans
- AMCA 301: Methods for Calculating Fan Sound Ratings from Laboratory Test Data
- ANSI/AMCA 330: Laboratory Method of Testing to Determine the Sound Power in a Duct
- ANSI/AMCA 500-L: Laboratory Methods of Testing Louvers for Rating AMCA Certified Ratings Program

Air-Conditioning, Heating, and Refrigeration Institute (AHRI)

- ANSI/AHRI 260: Sound Rating of Ducted Air Moving and Conditioning Equipment
- ANSI/AHRI Standard 350: Sound Rating of Non-ducted Indoor Air-Conditioning Equipment
- AHRI Standard 880: Performance Rating of Air Terminals

American Concrete Institute (ACI)

- ACI 318: Building Code Requirements for Structural Concrete and Commentary
- ACI 530: Building Code Requirements for Masonry Structures and Related Commentaries

American Institute of Steel Construction (AISC)

- AISC 303: Code of Standard Practice for Steel Buildings and Bridges
- AISC 341-16: Seismic Provisions for Structural Steel Buildings
- AISC 358-16: Prequalified Connections for Special and Intermediate Steel Moment Frames for Seismic Applications
- AISC 360: Specification for Structural Steel Buildings
- AISC Design Guide 11: Vibrations of Steel-Framed Structural Systems Due to Human Activity

American Iron and Steel Institute (AISI)

- AISI S100: North American Specification for the Design of Cold-Formed Steel Structural Members

American National Standards Institute (ANSI)

- ANSI C80.1: Electrical Rigid Steel Conduit

American Society of Civil Engineers (ASCE)

- ASCE/SEI 7-16: Minimum Design Loads and Associated Criteria for Buildings and Other Structures
- ASCE 25-06: Earthquake-Actuated Gas Shutoff Devices
- ASCE 41-17: Seismic Evaluation and Retrofit of Existing Buildings

American Society of Heating, Refrigerating and Air-Conditioning Engineers (ASHRAE)

- ASHRAE Standard 15: Safety Code for Mechanical Refrigeration
- ASHRAE Standard 34: Safety Classification of Refrigerants
- ASHRAE Standard 52.2: Method of Testing General Ventilation Air Cleaning Devices for Removal Efficiency by Particle Size
- ASHRAE Standard 55: Thermal

Environmental Conditions for Human Occupancy

ASHRAE Standard 62.1: Ventilation for Acceptable Indoor Air Quality

ASHRAE Standard 90.1: Energy Standard for Buildings Except Low-Rise Residential Buildings

ASHRAE Standard 100: Energy Efficiency in Existing Buildings

ASHRAE Standard 105: Standard Methods of Determining, Expressing, and Comparing Building Energy Performance and Greenhouse Gas Emissions

ASHRAE Standard 111: Measurement, Testing, Adjusting, and Balancing of Building HVAC Systems

ASHRAE Standard 135: BACnet: A Data Communication Protocol for Building Automation and Control Networks

ASHRAE Standard 135, Addendum bj: BACnet SC Secure Connect and the NIST Cybersecurity Framework

ASHRAE Standard 189.1: Standard for the Design of High-Performance Green Buildings Except Low-Rise Residential Buildings

ASHRAE Standard 223P: Designation and Classification of Semantic Tags for Building Data (*proposed at the time of writing*)

ASHRAE Handbooks and Guidelines

ASHRAE Handbook—Fundamentals

ASHRAE Handbook—HVAC Systems and Equipment

HVAC System Duct Design

Practical Guide to Seismic Restraint

ASHRAE Handbook—HVAC Applications

ASHRAE Guideline 4: Preparation of Operating and Maintenance Documentation for HVAC&R Systems

ASHRAE Guideline 36: High-

Performance Sequences of Operation for HVAC Systems

ASHRAE TC9.9: Data Center Power Equipment Thermal Guidelines and Best Practices

American Society of Mechanical Engineers (ASME)

ASME A17.5/CSA-B44.1: Elevator and Escalator Electrical Equipment

ASME A17.1: Safety Code for Elevators and Escalators, and all supplements as modified and adopted by the AHJ

ASME A17.1S: Safety Code for Elevators and Escalators, supplement to A17.1 as modified and adopted by the AHJ for Machine Room Less (MRL) installations

ASME A17.2: Guide for Inspection of Elevators, Escalators, and Moving Walks

ASME A17.3: Safety Code for Existing Elevators and Escalators, as modified and adopted by the AHJ

ASME A17.4: Guide for Emergency Personnel (including emergency evacuation of passengers from elevators)

American Society of Plumbing Engineers (ASPE)

ASPE Data Books

American Society for Testing and Materials (ASTM)

ASTM C423: Method for Measuring Sound Absorption

ASTM C1071: Standard Specification for Fibrous Glass Duct Lining Insulation (Thermal and Sound Absorbing Material)

ASTM D6754: Standard Specification for Ketone Ethylene Ester Based Sheet Roofing

ASTM E84: Standard Test Method for Surface Burning Characteristics of Building Materials

ASTM E90: Method for Measuring Sound Transmission Loss

APPENDIXES

CODES AND STANDARDS

List of Abbreviations
Index
Acknowledgments

ASTM E96: Standard Test Methods for Water Vapor Transmission of Materials

ASTM E413: Determination of Sound Transmission Class

ASTM E477: Test for Duct Lining and Silencer Performance

ASTM E492: Standard Test Method for Laboratory Measurement of Impact Sound Transmission Through Floor-Ceiling Assemblies Using the Tapping Machine

ASTM E779: Standard Test Method for Determining Air Leakage Rate by Fan Pressurization

ASTM G21: Standard Practice for Determining Resistance of Synthetic Polymeric Materials to Fungi

ASTM E1332: Standard Classification for Determination of Outdoor-Indoor Transmission Class

ASTM E2813: Standard Practice for Building Enclosure Commissioning

ASTM E3158: Standard Test Method for Measuring the Air Leakage Rate of a Large or Multizone Building

ASTM F476: Standard Test Methods for Security of Swinging Door Assemblies

ASTM F588: Standard Test Methods for Measuring the Forced Entry Resistance of Window Assemblies, Excluding Glazing Impact

ASTM F710: Standard Practice for Preparing Concrete Floors to Receive Resilient Flooring

ASTM F842: Standard Test Methods for Measuring the Forced Entry Resistance of Sliding Door Assemblies, Excluding Glazing Impact

ASTM F1642: Standard Test Method for Glazing and Glazing Systems Subject to Airblast Loadings

ASTM F1915: Standard Test Methods for Glazing for Detention Facilities

ASTM F2170: Standard Test Method for Determining Relative Humidity in Concrete Floor Slabs Using in situ Probes

ASTM F2656: Standard Test Method for Vehicle Crash Testing of Perimeter Barriers

ASTM F3010: Standard Practice for Two-Component Resin Based Membrane-Forming Moisture Mitigation Systems for Use Under Resilient Floor Coverings

American Water Works Association (AWWA)

AWWA C105: Polyethylene Encasement for Ductile-Iron Pipe Systems

American Welding Society (AWS)

Americans with Disabilities Act (ADA)

Americans with Disabilities Act Accessibility Guidelines (ADAAG) (Section 11)

Applied Technology Council (ATC)

ATC-40: Seismic Evaluation and Retrofit of Concrete Buildings

ATC-58: PACT Program Software

Architectural Woodwork Institute (AWI)

Audiovisual and Integrated Experience Association (AVIXA)

AVIXA A102.01:2017: Audio Coverage Uniformity in Listener Area

B

Board of State and Community Corrections (BSCC)

Building Industry Consulting Services International (BICSI)

BICSI Information Transport Systems Installation Manual (ITSIM)

BICSI Telecommunications Distribution

Methods Manual (TDMM)
BICSI Outside Plant Design Reference Manual (OSPDRM)
BICSI Wireless Design Reference Manual (WDRM)

Building Owners & Managers Association (BOMA)

Gross Areas of a Building: Standard Methods of Measurement

C

California Air Resources Board

Regulation for the Management of High Global Warming Potential Refrigerants for Stationary Sources

California Code of Regulations (CCR)

Title 8: Division 1, Chapter 4, Subchapter 7, General Industrial Safety Orders

Title 15: Division 1, Chapter 1, Subchapter 4, Minimum Standards for Local Detention Facilities

Title 16: Professional and Vocational Regulations

Title 17: Public Health, Section 95380 et seq. (Air Resources Board, Subarticle 5.1, Management of High Global Warming Potential Refrigerants for Stationary Sources)

Title 19: Public Safety, Division 1, State Fire Marshal

Title 22, Social Security, Division 4.5: Environmental Health Standards for the Management of Hazardous Waste

Title 24, Part 1, California Administrative Code (CAC)

Title 24, Part 2, California Building Code (CBC)

Title 24, Part 3, California Electrical Code (CEC)

Title 24, Part 4, California Mechanical Code (CMC)

Title 24, Part 5, California Plumbing Code (CPC)

Title 24, Part 6, California Energy Code (CEnC)

Title 24, Part 9, California Fire Code (CFC)

Title 24, Part 11, California Green Building Standards Code (CALGreen)

Title 24, Part 12, California Referenced Standards Code

California Department of Health Services

California Disabled Accessibility Guidebook (CALDAG)

California Energy Commission

Nonresidential Alternative Calculation Method Reference Manual

California Rules of Court

Rule 5.215, Domestic Violence Protocol for Family Court Services

Rule 10.180, Court Facilities Standards

Rule 10.181, Court Facilities Policies, Procedures, and Standards

California Standards of Judicial Administration

Standard 10.24

Crime Prevention Through Environmental Design (CPTED)

Cast Iron Soil Pipe Institute (CISPI)
CISPI Standards

Center for Universal Design

Code of Federal Regulations (CFR)

Title 40, Part 761: Polychlorinated Biphenyls (PCBs) Manufacturing, Processing, Distribution in Commerce, and Use Prohibitions

Canadian Standards Association (CSA)

Compliance Services and Assessments, LLC (CSA)

Concrete Reinforcing Steel Institute (CRSI)

Consumer Electronics Association (CEA)

ANSI/CEA-709.1-B-2000 Control Network Protocol Standards

APPENDICES

CODES AND STANDARDS

List of Abbreviations
Index
Acknowledgments

D

Division of the State Architect (DSA)

- Access Checklist
- Interpretation of Regulations (IR) 25-2.13
- IR 25-3.13
- Structural Safety (SS)

E

Electronic Industries Alliance (EIA/ECA)
EIA/ECA-310-D: Cabinets, Racks, Panels and Associated Equipment

Energy Efficiency Policy

Energy Independence and Security Act of 2007 (EISA)

Energy Star Portfolio Manager Technical Reference: Source Energy

F

Family Code

- Division 8, Custody of Children, Section 3113
- Division 8, Custody of Children, Section 3180
- Division 10, Prevention of Domestic Violence, Section 6218

Factory Mutual Global Standards

Federal Communications Commission (FCC)

- CFR Title 47, Part 15: Radio Frequency Devices

Federal Emergency Management Agency (FEMA)

- FEMA 74: Reducing the Risks of Nonstructural Earthquake Damage: A Practical Guide
- FEMA 412: Installing Seismic Restraints for Mechanical Equipment
- FEMA 413: Installing Seismic Restraints for Electrical Equipment
- FEMA 460: Seismic Considerations for Steel Storage Racks Located in Areas Accessible to the Public

FEMA: HAZUS Program Software

Federal Energy Management Program (FEMP)

Fiber Optic Testing Procedures

G–H

Green Building Action Plan

Government Code

Section 70391

Guiding Principles for Sustainable Federal Buildings

I

Illuminating Engineering Society (IES)

ANSI/IES TM-30-18 IES: Method for Evaluating Light Source Color Rendition

Lighting Handbook

InfoComm International

ANSI/INFOCOMM 2M: Standard Guide for Audiovisual Systems Design and Coordination Processes

AV Design Reference Manual

AV Installation Handbook

Dashboard for Controls Design Reference

Institute of Electrical and Electronics Engineers (IEEE)

IEEE C2: National Electrical Safety Code

IEEE 241: IEEE Recommended Practice for Electric Power Systems in Commercial Buildings (IEEE Gray Book)

IEEE 493: IEEE Recommended Practice for Design of Reliable Industrial and Commercial Power Systems (IEEE Gold Book)

IEEE 802.3ae: 10Gb/s Ethernet Standard

IEEE 802.3af & at: Power over Ethernet Standards

IEEE 802.11: Wireless Ethernet Standards, including 802.11a, 802.11b, 802.11g and 802.11n

IEEE 1100: IEEE Recommended Practice for Powering and Grounding Electronic Equipment (IEEE Emerald Book)

Instrument Society of America (ISA)
Instrument Data Sheets

International Association of Plumbing and Mechanical Officials (IAPMO)

International Building Code (IBC)

International Electrotechnical Commission (IEC)
IEC 60297-3-100: Mechanical Structures for Electronic Equipment—Dimensions of Mechanical Structures of the 482,6 mm (19 in) Series—Part 3-100: Basic Dimensions of Front Panels, Subracks, Chassis, Racks and Cabinets

International Organization for Standardization (ISO)
ISO 14044: Environmental management—Life cycle assessment—Requirements and guidelines

International Risk Insurance (IRI)

J–K

Judicial Council of California
Courthouse Naming Policy
Project Procedure A-14: Quality Management Plan
Statewide Action Plan for Serving Self-Represented Litigants

Justice for All: Designing Accessible Courthouses

L

LEED (Leadership in Energy and Environmental Design) Green Building Rating System, U.S. Green Building Council (USGBC)

M

Montreal Protocol

Model Water Efficient Landscape

Ordinance (MWEL0)

N

National Design Specifications (NDS)
Manual for Engineered Wood Construction
NDS for Wood Construction
NDS Supplement: Design Values for Wood Construction
Special Design Provisions for Wind and Seismic

National Electrical Manufacturers Association (NEMA)

National Electrical Contractors Association (NECA)
NECA/FOA 301: Standard for Installing and Testing Fiber Optics
ANSI/NECA/BICSI-568: Standard for Installing Commercial Building Telecommunication Cabling

National Fire Protection Association (NFPA)
NFPA 10: Portable Fire Extinguishers
NFPA 13: Standard for the Installation of Sprinkler Systems
NFPA 14: Standard for the Installation of Standpipe and Hose Systems
NFPA 17: Standard for Dry Chemical Extinguishing Systems

NFPA 20: Standard for the Installation of Stationary Pumps for Fire Protection

NFPA 22: Standard for Water Tanks for Private Fire Protection

NFPA 24: Installation of Private Fire Service Mains and Their Appurtenances

NFPA 25: Water-Based Fire Protection Systems

NFPA 30: Flammable and Combustible Liquids Code

NFPA 37: Standard for the Installation and Use of Stationary Combustion Engines and Gas Turbines

NFPA 54/ANSI Z223.1: National Fuel Gas

APPENDICES

CODES AND STANDARDS

List of Abbreviations
Index
Acknowledgments

Code	Development (OSHPD)
NFPA 70: National Electrical Code (NEC)	OSHPD Preapproved Details (OPD)
NFPA 72: National Fire Alarm and Signaling Code	
NFPA 80: Standard for Fire Doors and Other Opening Protectives	
NFPA 90A: Standard for Installation of Air-Conditioning and Ventilation Systems	
NFPA 96: Standard for Ventilation Control and Fire Protection of Commercial Cooking Spaces	
NFPA 101: Life Safety Code	
NFPA 110: Standard for Emergency and Standby Power Systems	
NFPA 111: Stored Electrical Energy Emergency and Standby Power Systems	
NFPA 780: Standard for the Installation of Lightning Protection Systems, Annex L	
NFPA 2001: Clean Agent Fire Suppression System	
National Floor Safety Institute (NFSI)	
B101.1: Test Method for Measuring Wet SCOF of Common Hard-Surface Floor Materials	
B101.6: Standard Guide for Commercial Entrance Matting in Reducing Slips, Trips and Falls	
National Institute of Standards and Technology (NIST)	
Cybersecurity Framework	
National Institute for Occupational Safety and Health (NIOSH)	
Guidance for Protecting Building Environments from Airborne Chemical, Biological, or Radiological Attacks	
O	
Office of Statewide Health Planning and	
	Development (OSHPD)
	OSHPD Preapproved Details (OPD)
	P–Q
	Principles of Universal Design
	R
	Research Council on Structural Connections (RCSC)
	S
	Savings By Design
	Sheet Metal and Air Conditioning Contractors’ National Association, Inc. (SMACNA)
	SMACNA HVAC Duct Construction Standards: Metal and Flexible
	SMACNA HVAC Air Duct Leakage Test Manual
	SMACNA Fire, Smoke, and Radiation Damper Installation Guide for HVAC Systems
	State Administrative Manual (SAM)
	State Executive Order (EO)
	B-18-12
	B-30-15
	State of California Green Buildings website, www.green.ca.gov/Buildings/
	T
	Telecommunications Industry Association (TIA)
	ANSI/TIA-492.AAAD: Detail Specification for 850-nm Laser-Optimized, 50-µm Core Diameter/125-µm Cladding Diameter Class Ia Graded-Index Multimode Optical Fibers Suitable for Manufacturing OM4 Cabled Optical Fiber
	ANSI/TIA-492.CAAB: Detail Specification for Class IVa Dispersion-

Unshifted Single-Mode Optical Fibers with Low Water Peak

ANSI/TIA/EIA-526-7: Measurement of Optical Power Loss of Installed Single-Mode Fiber Cable Plant

ANSI/TIA/EIA-526-14A: Measurement of Optical Power Loss of Installed Multimode Fiber Cable Plant

ANSI/TIA/EIA-568-C.0: Generic Telecommunications Cabling for Customer Premises

ANSI/TIA/EIA-568-C.1: Commercial Building Telecommunications Cabling Standard Part 1: General Requirements

ANSI/TIA/EIA-568-C.2: Commercial Building Telecommunications Cabling Standard Part 2: Balanced Twisted-Pair Cabling Components

ANSI/TIA/EIA-568-C.3: Commercial Building Telecommunications Cabling Standard Part 3: Optical Fiber Cabling Components

ANSI/TIA/EIA-568-C.3-1: Addendum 1, Addition of OM4 Cabled Optical Fiber and Array Connectivity

ANSI/TIA-568.0-D: Generic Telecommunications Cabling for Customer Premises

ANSI/TIA/EIA-568.3-D: Optical Fiber Cabling Components

ANSI/TIA/EIA-569-D: Commercial Building Standard for Telecommunications Pathways and Spaces

ANSI/TIA/EIA-598-C: Optical Fiber

ANSI/TIA/EIA 606A/B/C: Administration Standard for Commercial Telecommunications Infrastructure

ANSI/TIA/EIA-607-C: Commercial Building Grounding (Earthing) and Bonding Requirements for Telecommunications

ANSI/TIA/EIA-758-B: Customer-owned Outside Plant Telecommunications

Infrastructure Standard

ANSI/TIA 862: Building Automation Systems Cabling Standards for Commercial Buildings

ANSI/TIA-942: Telecommunications Infrastructure for Data Centers

ANSI/TIA-1152: Requirements for Field Test Instruments and Measurements for Balanced Twisted-Pair Cabling

U-Z

U.S. Army Corps of Engineers

PDC-TR 06-02, Rev. 1, Protective Design Center Technical Report

PDC-TR 06-08, Rev. 1, Single Degree of Freedom Structural Response Limits for Antiterrorism Design

U.S. Court Design Guide

U.S. General Services Administration

Facilities Standards for the Public Buildings Service

U.S. Green Building Council (USGBC)

Underwriters Laboratories (UL)

UL 181: Standard for Factory-Made Air Ducts and Air Connectors

UL 300: Standard for Fire Testing of Fire Extinguishing Systems for Protection of Commercial Cooking Equipment

UL 464: Audible Signaling Devices for Fire Alarm and Signaling Systems, Including Accessories

UL 521: Standard for Heat Detectors for Fire Protective Signaling Systems

UL 752: Standard for Bullet-Resisting Equipment

UL 916: Standard for Energy Management Equipment

UL 924: Standard for Emergency Lighting and Power Equipment

UL 1449: Standard for Surge Protective Devices

UL 1971: Standard for Signaling Devices for the Hearing-Impaired Standards

APPENDICES

CODES AND STANDARDS

List of Abbreviations
Index
Acknowledgments

Unified Facilities Criteria (UFC)

UFC 4-023: Design of Buildings to Resist
Progressive Collapse

**Uniform Federal Accessibility Standards
(UFAS)**

Welfare and Institutions Code

Section 300 et seq.

Section 325 et seq.

DRAFT

APPENDIXES

LIST OF ABBREVIATIONS

DRAFT

°C degrees Celsius
°F degrees Fahrenheit
% percent
4W four wire

A

A or Amp ampere
ABB ASEA (Allmänna Svenska Elektriska Aktiebolaget) Brown Boveri
ACI American Concrete Institute
ACU Audio Coverage Uniformity
ADA Americans with Disabilities Act of 1990
ADAAG Americans with Disabilities Act Accessibility Guidelines or ADA Accessibility Guidelines
ADR alternative dispute resolution
AFF above finished floor
AHJ authority/authorities having jurisdiction
AHRI Air-Conditioning, Heating, and Refrigeration Institute
AHU air-handling unit
AISC American Institute of Steel Construction
AISI American Iron and Steel Institute
ALS assistive listening system
AMCA Air Movement and Control Association
ANSI American National Standards Institute
a_o acceleration
a_p peak acceleration
Arch. architecture
ARMM abrasion resistant millimeters
ASCE American Society of Civil Engineers
ASHRAE American Society of Heating, Refrigerating and Air-Conditioning Engineers
ASME American Society of Mechanical Engineers
ASPE American Society of Plumbing Engineers
ASTM American Society for Testing and Materials
ATC Applied Technology Council
ATTY attorney
AV audiovisual

AVIXA Audiovisual and Integrated Experience Association
AWG American Wire Gauge
AWI Architectural Woodwork Institute
AWS American Welding Society
AWWA American Water Works Association

B

BACnet Building Automation and Control Network
BAS building automation system
BECx Building Enclosure Commissioning
BGSF building gross square feet
BICSI Building Industry Consulting Services International
BMS building management system
BOMA Building Owners and Managers Association
BSCC Board of State and Community Corrections
BTL BACnet Testing Laboratories
Btu British thermal unit

C

CA California
CAC California Administrative Code
CAL California
Cal/OSHA California Occupational Safety and Health Administration
CALDAG California Disabled Accessibility Guidebook
CALGreen California Green Building Standards Code
CATV community antenna television (cable television)
CBC California Building Code
Cal. Code Regs. California Code of Regulations
CEA Consumer Electronics Association
CEC California Electrical Code
CEO court executive officer
CFAC Court Facilities Advisory Committee

CFC California Fire Code
CFCs chlorofluorocarbons
cfm cubic feet per minute
CFM customer flow management
CFR Code of Federal Regulations
CGSF component gross square feet
CISPI Cast Iron Soil Pipe Institute
CLG. MTD. ceiling mounted
CMC California Mechanical Code
CMU concrete masonry unit
CO₂ carbon dioxide
CONF conference
CPC California Plumbing Code
CPTED Crime Prevention Through Environmental Design
CPUC California Public Utilities Commission
CRI color rendering index
CRSI Concrete Reinforcing Steel Institute
CSA Canadian Standards Association
CSA Compliance Services and Assessments, LLC
CSO court security officer
CxA certified commissioning authority/agent or commissioning authority/agent

D

DAS distributed antenna system
dB decibels
dba decibels, A-weighted
DCR detention control room
DCS detention control system
DDC direct digital control
Delta T temperature difference
DEPS digital evidence presentation system
DLCS detention lock control system
DMZ demilitarized zone
DNA deoxyribonucleic acid
DPDT double pole, double throw
DSA Division of the State Architect
DSA-SS Division of the State Architect—Structural Safety

DVD digital versatile disc
DVI Digital Visual Interface
DX direct expansion

E

e.g. for example
EIA/ECA Electronic Industries Alliance standards
EISA Energy Independence and Security Act of 2007
EL elevation
ELEC electric/electrical
EMT electrical metallic tubing
EO executive order
EPDM ethylene propylene diene monomer
ERL electronic resettable link
et seq. et sequens
etc. etcetera
exp exponential

F

FAA Federal Aviation Administration
FAIA Fellow of the American Institute of Architects
FC foot-candle
FCC Federal Communications Commission
FCS Family Court Services
FDC fire department connections
FEMA Federal Emergency Management Agency
FEMP Federal Energy Management Program
f_n natural frequency
FOA Fiber Optic Association
fpm feet per minute
fps feet per second
ft. feet
FT² square foot/feet
FW firewall

APPENDICES

Codes and Standards

LIST OF ABBREVIATIONS

Index
 Acknowledgments

G

g gravity
Gb gigabyte
gpm gallons per minute
GSF gross square feet
GUI graphical user interface

H

h hour
HDMI High-Definition Multimedia Interface
Hg mercury
HP horsepower
hr hour
HTML hypertext markup language
HVAC heating, ventilation, and air-conditioning

I

I.D. identification
IAPMO International Association of Plumbing and Mechanical Officials
IBC International Building Code
ID inside diameter
IDF intermediate distribution frame
IEC International Electrotechnical Commission
IEEE Institute of Electrical and Electronics Engineers
IES Illuminating Engineering Society
IIC impact insulation class
incl. including
IP Internet Protocol
IPTV Internet Protocol Television
IR infrared; Interpretation of Regulations
IRI International Risk Insurance
IS Information Systems
ISA Instrument Society of America
ISO International Organization for Standardization
ISP inside plant
IT information technology
ITSIM Information Transport Systems Installation Manual

K

km kilometer
kVA kilovolt-amps
kVAR kilovolt-ampere reactive
kVARh kilovolt-ampere reactive hour
kW kilowatt
kWh kilowatt-hour

L

L10 measured noise level that is exceeded 10 percent of the measurement period
L70 70% of the Initial Lumens
LAN local area network
lb. pound/pounds
LC latched connector
LCC life cycle cost
LCCA life cycle cost analysis
LCD liquid crystal display
LED light-emitting diode
LEED Leadership in Energy and Environmental Design
LEP limited English proficient
LJS latex joint sealants
LOMMF laser-optimized multimode fiber

M

MAX maximum
MC metal clad
MDF main distribution frame
Mech. mechanical
MEP mechanical, electrical, and plumbing
MERV minimum efficiency reporting value
min. minimum
misc. miscellaneous
MPOE minimum point of entry
MRL machine room less
msec. millisecond
MSF modular systems furniture
MWELO Model Water Efficient Landscape Ordinance

N

N/A not applicable

NAS network-attached storage

NC Noise Criteria

NDS National Design Specifications

NEC National Electrical Code

NECA National Electrical Contractors Association

NEMA National Electrical Manufacturers Association

NFPA National Fire Protection Association

NFSI National Floor Safety Institute

NIC noise isolation class

NIOSH National Institute for Occupational Safety and Health

NIST National Institute of Standards and Technology

nm nanometer

NPLV nonstandard part load values

NRC noise reduction coefficient

NSC nonstructural seismic coordinator

NSF net square feet

O

OITC outdoor-indoor transmission class

OPEX operating/operations expense/ expenditure

OSHA Occupational Safety and Health Administration

OSHPD Office of Statewide Health Planning and Development

OSP outside plant

OSPDRM Outside Plant Design Reference Manual

P

PACT Performance Assessment Calculation Tool

PC personal computer

PDC Protective Design Center

PECI Portland Energy Conservation, Inc.

perm unit of permeation

PEX cross-linked polyethylene

PH phase

pH potential of hydrogen

PIN personal identification number

PIV post indicator valve

PLC programmable logic controller

P_o constant force representing the excitation, pounds

PoE Power over Ethernet

psf pounds per square foot

psi pounds per square inch

pt. part

PTZ pan-tilt-zoom

PV present value

PVB polyvinyl butyral

PVC polyvinyl chloride

R

R9 fidelity red

R_a average color rendering index value

RA risk assessment

RC Room Criteria

RCSC Research Council on Structural Connections

Regs. regulations

REX request-to-exit

RF radio frequency

R_f fidelity Index

R_g gamut Index

RH relative humidity

RHH rubber-insulated, high-heat resistant

rpm revolution/s per minute

RT reverberation time

S

SC Secure Connect

SDI serial digital interface

SEI Structural Engineering Institute

SF/ft² square foot/feet

SGF security epoxy resin gap filler

SJS security joint sealant

APPENDICES

Codes and Standards

LIST OF ABBREVIATIONS

Index

Acknowledgments

SMACNA Sheet Metal and Air Conditioning Contractors' National Association

SMF single-mode fiber

SMS security management system

SMS short message service

SOC security operations center

SR strongly recommended

SS Security System

SS Structural Safety

STC sound transmission class

Syslog system logging protocol

T

TARR Texture Appearance Retention Rating

TBD to be determined

TC Technical Committee

TCP temperature control panel/field panel

TCP Transmission Control Protocol

TDD telecommunications device for the deaf

TDM transportation demand management

TDMM *Telecommunications Distribution Methods Manual*

TEFC totally enclosed, fan cooled

THHN thermoplastic high-heat-resistant nylon-coated

THWN thermoplastic heat- and water-resistant nylon-coated

TIA Telecommunications Industry Association

tit. title

TM Technical Memorandum

TNT trinitrotoluene

TR Technical Report

TSS Total Security Solutions

TV television

TVSS transient voltage surge suppressor

U

UFAS Uniform Federal Accessibility Standards

UFC Unified Facilities Criteria

UL Underwriters Laboratories

UPS uninterruptible power supply/source

U.S. United States

USGBC U.S. Green Building Council

UTP unshielded twisted pair

V

V volt

VA volt-amps

VAC volts of alternating current

VAV variable air volume

VCT vinyl composition tile

VDC volts of direct current

VDT video/visual display terminal

VFD variable-frequency drive

VLAN virtual local area network

VOC volatile organic compound

VoIP Voice over Internet Protocol

VSD variable-speed drive

VSS video surveillance system

W

W Effective Weight

W wire

WC water column; wheelchair

WAN wide area network

WAP wireless access point

WDRM *Wireless Design Reference Manual*

WLAN wireless local area network

WRB weather-resistive barrier

X

XHHW cross-linked polyethylene, high-heat resistance, water-resistance

DRAFT

APPENDICES

Codes and Standards

**LIST OF
ABBREVIATIONS**

Index

Acknowledgments

DRAFT

APPENDIXES

INDEX

DRAFT

A

access control, 4.4–4.5, 4.19–4.20

accessibility
of courtrooms, 5.5–5.6
importance of, 1.3–1.4
parking and, 3.4
Universal Design principles and, 1.3–1.4

access panels, 8.20, 13.13

acoustical design
background noise levels, 19.2
best practices for, 19.8–19.11
criteria for, 19.2–19.8
environmental noise study, 19.7–19.8
impact insulation, 19.7
objectives of, 19.2
room acoustics, 19.2–19.4, 19.11
sound isolation, 13.10, 19.2, 19.4–19.5, 19.6, 19.10–19.11
speech privacy, 19.2, 19.4, 19.10–19.11

airflow measuring devices, 13.18

air-handling units, 13.3, 13.19–13.24

alarm systems
duress, 4.20, 6.5
fire protection, 20.8–20.10

alternative dispute resolution, 2.9, 4.31, 7.6–7.7

architectural elements. *See also individual elements*
exterior, 11.2–11.9
interior, 11.9–11.17
signage, 11.17–11.20

area and volume definitions, 2.6–2.7

armory, 8.12, 8.33

arraignment
courtrooms, 2.8, 5.3, 5.22–5.23
videoconferencing, 18.6

assistive listening systems, 18.3, 18.6, 18.9–18.13

attorney-client interview rooms. *See* interview rooms

attorney convenience centers, 4.31, 7.7

audiovisual systems
assistive listening, 18.3
cabinets for, 18.3
cabling infrastructure for, 18.3
control systems for, 18.6
criteria for, 18.2

digital evidence presentation, 18.6

digital signage/customer flow management, 18.8

integration of, 18.2

reliability of, 18.2

scalability of, 18.2

speech and audio reinforcement, 18.3

sustainability and, 18.2

video display, 18.6

videoconferencing/arraignment, 18.6

B

background noise levels, 19.2

barrier walls, 11.3–11.4

benches. *See* detention benches; judge's bench

bird roosting and nesting control, 11.9

blast
building envelope and, 4.11–4.12
evacuation after, 4.12–4.14
setback distance and, 4.5–4.8, 4.23

blood draw rooms, 7.8

break rooms, 6.11, 8.13, 11.16, 13.4

building automation system (BAS). *See* building management system

building directory, 11.19

building gross square feet (BGSF), 2.6–2.7

building management system (BMS)
components of, 14.2–14.4
energy conservation design and, 14.4–14.5
level of integration of, 14.4

building orientation, 1.4–1.5, 3.5

building support services
fire alarm and emergency communication system control room, 10.4
janitor closets, 10.2
lighting and, 16.9
loading dock, 10.2
mailroom, 10.3
maintenance shops, 10.3
news media functions, 10.3
security and, 4.32
space standards for, 2.9
storage, 10.3

bullet-resistant glazing, 4.21–4.22

C

- cabinets, 11.17, 18.3
- cabling
 - for audiovisual systems, 18.3
 - security and, 4.21, 8.32
 - for network and communication systems, 17.2, 17.3, 17.11–17.16
- calendar postings, 11.19
- California, state seal of, 11.15
- cameras, 8.32, 8.33. *See also* video
- card access control, 4.19
- carpets, 11.14
- casework, 11.17
- ceilings
 - finishes for, 11.16
 - heights of, 2.5
 - impact insulation and, 19.7
 - in in-custody areas, 8.15
 - planning and design of, 11.10
 - recommended reflectance for, 16.5
- cellular service, 17.25–17.26
- cement plaster cladding, 11.4–11.5
- children’s waiting rooms
 - finishes for, 11.16
 - planning and design of, 7.5, 7.6
 - security and, 4.17, 4.24, 4.31
- chilled water systems, 13.7–13.8
- circulation areas
 - lighting for, 16.3, 16.9
 - security and, 4.16, 4.29, 8.10
- circulation zones, 2.2–2.5
- clerk’s office
 - background noise criteria for, 19.2
 - ceiling height of, 2.5
 - room acoustics requirements for, 19.3
 - security and, 4.24
- clerk’s station
 - audiovisual system requirements for, 18.3, 18.4, 18.5
 - communications outlets for, 17.17
 - lighting for, 16.3
 - planning and design of, 5.5, 5.8–5.9
 - security and, 4.23, 4.29
- CO₂ demand control, 14.6
- collapse, resistance to, 4.12–4.13
- communications. *See* network and communication systems
- component gross square feet (CGSF), 2.4, 2.6, 2.7
- conductors, 15.5–15.6
- conduits, 15.6
- conference rooms
 - allocating space for, 6.10
 - audiovisual system requirements for, 18.13
 - background noise criteria for, 19.2
 - for Family Court Services, 7.4–7.5
 - finishes for, 11.16
 - lighting for, 16.3
 - occupant density of, 13.4
 - power requirements for, 13.4, 15.3
 - room acoustics requirements for, 19.3
 - size of, 2.8, 2.12, 6.10
 - temperature of, 13.4
- copy rooms, 2.8, 5.16, 11.16, 13.4, 13.13
- cornerstones, 11.7
- corridors
 - background noise criteria for, 19.2
 - ceiling height of, 2.5
 - finishes for, 11.16
 - floor vibration acceptance criteria for, 12.3
 - in in-custody areas, 8.33
 - as public waiting areas, 9.5
 - width of, 2.5–2.6
- counsel tables
 - audiovisual system requirements for, 18.10
 - communications outlets for, 17.17
 - lighting for, 16.3
 - planning and design of, 5.5, 5.12
- counters
 - finishes for, 11.16
 - lighting for, 16.9
 - planning and design of, 6.5–6.7
 - security and, 4.9, 4.17, 4.22, 4.24, 4.29, 4.30
- court administration spaces
 - conference and training rooms, 6.10
 - court executive officer’s area, 6.7–6.11
 - equipment storage, 6.11
 - human resources, 6.9
 - mail center, 6.10
 - offices and workstations, 6.8
 - other support areas, 6.11
 - public service counters, 6.5–6.7
 - purchasing, 6.8
 - records storage, 6.9
 - revenue and collections, 6.7
 - security and, 4.30, 6.5
 - size of, 2.8

APPENDIXES

Codes and Standards
List of Abbreviations

INDEX

Acknowledgments

- court executive officer's area, 6.7–6.11
 - courthouses. *See also individual spaces, systems, and services*
 - circulation zones for, 2.2–2.5
 - entrances to, 3.6, 9.2
 - landscape design and, 3.7–3.8
 - life cycle cost analysis for, 1.2–1.3, 1.4, 1.6
 - naming of, 11.20
 - orientation of, 1.4–1.5, 3.5
 - pedestrian access to, 1.4, 3.6
 - relative building volume ratio for, 2.7
 - signage for, 11.17–11.20
 - site design for, 3.2–3.8
 - size of, 2.5–2.8, 3.5–3.6
 - space standards for, 2.5, 2.8–2.12
 - court reporter's room
 - planning and design of, 5.16
 - security and, 4.30
 - court reporter's area/station
 - communications outlets for, 17.17
 - planning and design of, 5.5, 5.10, 5.16
 - size of, 2.8
 - courtroom holding, 8.11–8.12
 - courtrooms. *See also individual components*
 - accessibility and, 5.5–5.6
 - adjacencies for, 5.4
 - arraignment, 2.8, 5.3, 5.22–5.23
 - audiovisual system requirements for, 18.3–18.5, 18.8–18.11
 - background noise criteria for, 19.2
 - bench configuration for, 5.4–5.5
 - BGSF per, 2.6–2.7
 - ceiling height of, 2.5
 - components of, 5.5, 5.6–5.15
 - entries to, 2.8, 5.4, 5.15
 - finishes for, 11.15, 11.16, 11.17
 - floor organization of, 5.2
 - floor vibration acceptance criteria for, 12.3
 - large, 2.8
 - lighting for, 16.3, 16.8, 16.10
 - mockups of, 5.4, 5.6
 - multipurpose, 2.8, 5.3–5.4, 5.20–5.21, 17.18–17.19
 - occupant density of, 13.4
 - planning and design of, 5.2–5.3
 - platforms in, 11.14
 - power requirements for, 13.4, 15.3
 - room acoustics requirements for, 19.3
 - security and, 4.9, 4.16, 4.23, 4.29
 - signage for, 11.17–11.20
 - size of, 2.8
 - support spaces for, 5.15–5.19
 - temperature of, 13.4
 - types of, 5.3
 - court security officer (CSO) station, 5.5, 5.13
 - court set. *See also individual components*
 - definition of, 5.2
 - security and, 4.29
 - space standards for, 2.8
 - Crime Prevention Through Environmental Design (CPTED), 4.4–4.5
 - customer flow management (CFM), 18.8
- ## D
- damp proofing, 11.3
 - daylighting, 11.9, 16.10–16.11
 - dedication plaques, 11.7
 - defendants. *See in-custody areas*
 - demand base reset control, 14.6
 - design excellence principles, 1.5–1.6
 - detention benches, 8.16, 8.20
 - detention circulation system, 2.5, 8.10, 8.28
 - detention control rooms, 2.9, 8.7–8.8
 - detention control systems, 8.24–8.33
 - diffusers, 13.3
 - digital evidence presentation system (DEPS), 18.6
 - digital signage system, 18.8
 - dining areas, 15.3, 19.2
 - direct evaporative coolers, 13.10–13.11
 - direct expansion systems, 13.8
 - directories, 11.19
 - distributed antenna system (DAS), 17.25–17.26
 - DNA swab rooms, 7.8
 - door frames, 8.16, 8.19–8.20, 11.12–11.13
 - doors
 - exterior, 11.6
 - in in-custody areas, 8.16, 8.17–8.19, 8.21, 8.24, 8.26–8.27, 8.33
 - security and, 4.12, 4.25, 4.26, 4.28, 4.29
 - sound isolation requirements for, 19.4, 19.6
 - drainage plane walls, 11.3–11.4
 - drains, 13.15
 - driveways, 4.21, 4.28, 8.24–8.25, 8.33
 - drop boxes, 6.7

drug testing suites, 7.7

ductwork
 acoustical isolation and, 13.10
 insulation of, 13.17
 planning and design of, 13.5

duress alarm system, 4.20, 6.5

E

earthquakes, 12.4

electrical systems
 conductors, 15.5–15.6
 conduits, 15.6
 coordination of, 15.7
 criteria for, 15.2–15.8
 distribution studies for, 15.7
 emergency and standby power systems, 15.9–15.13
 equipment enclosures for, 10.4
 grounding, 15.8
 identification of, 15.7
 minimum load power requirements, 15.3
 planning and design of, 15.2
 power distribution, 15.7–15.8
 quality assurance of, 15.7
 security and, 4.14–4.15, 4.26, 4.32
 space for, 2.7
 spare capacity requirements, 15.3, 15.12

electronic security systems
 location of, 4.18–4.19
 planning, 4.19–4.21
 standards for, 4.28–4.32
 types of, 4.19–4.21

elevators
 detention circulation and, 8.10, 8.28, 8.33
 mechanical requirements for, 13.12
 noise reduction and, 19.10
 planning and design of, 11.11–11.12

emergency lighting, 16.7–16.8

emergency power systems, 15.9–15.13

energy conservation
 mechanical systems and, 13.2

entrances
 lighting for, 16.4
 orienting, 3.5
 primary building, 3.5, 9.2
 security and, 4.28
 separate, for judges and bench officers, 3.6
 service, 17.4–17.5, 17.12
 signage for, 11.18
 weather exposure and, 11.6

environmental noise study, 19.7–19.8

equipment insulation, 13.17

escalators
 noise reduction and, 19.10

evacuation, 4.12–4.13

evidence
 presentation system for, 18.6
 storage for, 2.8, 4.10, 4.17, 4.25, 4.30, 5.15

exhibits
 display area for, 5.12
 storage for, 2.8, 4.9, 4.17, 4.25, 4.30, 5.15

exit signs, 16.6

expansion joints, 11.5

exterior construction, 11.2–11.9

exterior lighting, 16.6–16.7

F

façade access equipment, 11.8–11.9

Family Court Services, 4.17, 7.3–7.6

family law facilitators, 2.9, 4.31, 7.2–7.3

fasteners, tamper-proof, 8.23

Federal Energy Management Program (FEMP), 1.3

files. *See also* records
 lighting for, 16.3, 16.9
 planning and design of, 11.15
 power requirements for, 15.3
 security and, 4.17, 4.25
 service loads for, 12.3

fingerprinting, 7.8

finishes, interior, 11.15, 11.16, 11.17, 20.2

fin-tube heating systems, 13.9

fire department connections (FDC), 20.6

fire protection systems
 alarm systems, 10.4, 20.8–20.10
 automatic sprinkler systems, 20.2–20.3
 cleaning, 20.7
 control room, 4.18, 10.4
 coordination, 20.7
 criteria for, 20.2–20.7
 fire department connections (FDC), 20.6
 fire pump requirements, 20.4
 guarantee, 20.7, 20.10
 hydrants, 20.3–20.4
 installation contractor certification, 20.7, 20.10

APPENDICES

Codes and Standards
 List of Abbreviations

INDEX

Acknowledgments

- interior finishes, 20.2
 - for MDF/server equipment room, 20.6–20.7
 - objectives for, 20.2
 - pipng requirements, 20.4–20.5
 - pipng specialties, 20.5–20.6
 - post indicator valve (PIV) assembly, 20.6
 - security and, 4.14–4.15, 4.26
 - sprinkler control valves, 20.6
 - valve requirements, 20.5
 - flagpoles, 3.6, 11.7, 11.15
 - flashing, 11.4–11.5
 - flexibility, planning for, 1.5
 - floods, 12.5
 - floor drains, 13.15
 - flooring materials, 11.14, 11.16
 - floors
 - impact insulation and, 19.7
 - in in-custody areas, 8.13–8.14
 - recommended reflectance for, 16.5
 - vibration of, 12.3
 - floor-to-floor heights, 11.9
 - fluorescent lamps, 16.2
 - flutter echo, 19.3, 19.4
 - footbridges, 12.3
 - footfall noise, 19.7
 - four-pair copper cable, 17.16
 - fuel pipng, 13.16
- G**
- generators, emergency, 4.8, 4.14, 13.12, 15.9–15.13
 - glare control, 11.6
 - glazing
 - blast load and, 4.12
 - bullet-resistant, 4.21–4.22
 - in in-custody areas, 8.16, 8.21
 - gravity loads, 12.2–2.3
 - grilles
 - mechanical, 8.22
 - walk-off, 11.6–11.7
 - grounding system, 15.8, 17.11
 - growth, planning for, 1.5
 - gun lockers, 8.16, 8.20
- H**
- heat gains, internal, 13.6
 - heating systems, 13.8–13.9. *See also* HVAC
 - holding areas
 - ceiling height of, 2.5
 - central, 8.8–8.10
 - courtroom, 8.11–8.12
 - electronic detention control requirements for, 8.33
 - lighting for, 16.3, 16.9
 - mechanical requirements for, 13.12
 - occupant density of, 13.4
 - power requirements for, 15.3
 - size of, 2.9
 - support areas for, 8.12–8.13
 - temperature of, 13.4
 - housekeeping pads, 13.13
 - human comfort performance levels, 12.3
 - human resources, 6.9
 - humidifiers, 13.10–13.11
 - HVAC
 - background noise from, 19.2, 19.8–19.9
 - criteria for, 13.3–13.10
 - equipment enclosures for, 10.4
 - planning and design of, 13.2
 - hydrants, 20.3
- I**
- illuminance levels, recommended, 16.3–16.4
 - impact insulation, 19.7
 - incandescent lamps, 16.2
 - in-custody areas. *See also individual components*
 - benches in, 8.16, 8.20
 - components of, 8.5–8.13
 - construction/finishes in, 8.13–8.15
 - detention equipment in, 8.16, 8.20
 - door signage in, 8.24
 - doors in, 8.16, 8.17–8.19, 8.21, 8.24, 8.26–8.27, 8.33
 - electronic detention control system in, 8.24–8.33
 - fasteners in, 8.23
 - frames in, 8.16, 8.19–8.20, 8.23
 - functional overview of, 8.3–8.5
 - glazing in, 8.16, 8.21
 - light fixtures in, 8.21
 - mechanical grilles in, 8.22
 - mechanical requirements for, 13.12

- planning and design of, 8.2–8.3
- plumbing fixtures in, 8.22
- sealants in, 8.23
- space standards for, 2.9
- sprinkler heads, 8.22
- technical criteria for, 8.13–8.24
- toilet accessories in, 8.24

information kiosks/counters, 2.9, 4.29, 9.4–9.5

information systems

- security and, 4.32
- space standards for, 2.8

inside plant (ISP) pathways, 17.12–17.14

insulation, 13.17

intercom system, 8.31–8.32, 17.17

interior construction

- fire protection and, 20.2
- planning and design of, 11.9–11.17

intermediate distribution frame (IDF) rooms

- definition of, 17.7
- electronic security systems and, 4.18–4.19
- occupant density of, 13.4
- planning and design of, 17.7–17.9
- power requirements for, 13.4, 15.3
- security and, 4.32
- space considerations for, 17.8
- temperature of, 13.4

interpreters

- communications outlets for, 17.17
- convenience centers for, 7.8

interview rooms, 2.8, 5.18, 8.10–8.11, 8.27

intrusion detection, 4.20

IP network, 17.21–17.24

J

janitor closets

- finishes for, 11.16
- in holding areas, 8.13
- lighting for, 16.9
- mechanical requirements for, 13.12
- occupant density of, 13.4
- planning and design of, 10.2
- size of, 2.9
- temperature of, 13.4

judge's bench

- communications outlets for, 17.17
- corner vs. center, 5.4–5.5
- lighting for, 16.3

- planning and design of, 5.4, 5.5, 5.6–5.7
- security and, 4.22, 4.29

judge's/judicial chambers

- background noise criteria for, 19.2
- ceiling height of, 2.5
- lighting for, 16.8
- occupant density of, 13.4
- planning and design of, 5.15–5.16
- power requirements for, 13.4, 15.3
- room acoustics requirements for, 19.3
- security and, 4.9, 4.16, 4.24, 4.30
- size of, 2.8
- temperature of, 13.4

jury assembly rooms

- audiovisual system requirements for, 18.12
- ceiling height of, 2.5
- finishes for, 11.16
- floor vibration acceptance criteria for, 12.3
- lighting for, 16.3, 16.10
- planning and design of, 6.3
- security and, 4.30
- size of, 2.8

jury boxes

- planning and design of, 5.10–5.12
- security and, 5.12

jury deliberation rooms

- background noise criteria for, 19.2
- ceiling height of, 2.5
- finishes for, 11.16
- occupant density of, 13.4
- planning and design of, 5.17
- power requirements for, 13.4, 15.3
- room acoustics requirements for, 19.3
- security and, 4.9, 4.17, 4.24, 4.30
- size of, 2.8
- temperature of, 13.4

jury support staff, 6.4

K

kitchens, 13.4, 15.3

L

lactation rooms, 2.8, 6.11

landscape design, 3.7–3.8

laser-optimized multimode (LOMMF) cable, 17.14–17.15

law enforcement waiting rooms, 2.8, 7.7–7.8

law library, 5.16

lecterns, 5.5, 5.12, 17.17

APPENDIXES

Codes and Standards
List of Abbreviations

INDEX

Acknowledgments

- LED, 16.2
 - LEED Silver rating, 1.6
 - life cycle cost analysis (LCCA), 1.2–1.3, 12.4, 12.6
 - lifts, 5.6
 - lighting. *See also* lighting fixtures
 - commissioning, 16.11
 - controls for, 16.10–16.11
 - criteria for, 16.2–16.6
 - day-, 11.9, 16.10–16.11
 - emergency, 16.7–16.8
 - energy efficiency and, 16.2, 16.6
 - exterior, 16.6–16.7
 - maintenance, 16.6
 - planning and design of, 16.2
 - recommended illuminance levels, 16.3–16.4
 - reflectance values, 16.2, 16.5
 - security, 16.7
 - strategies for, 16.6–16.10
 - lighting fixtures (luminaires)
 - energy efficiency of, 16.6
 - in in-custody areas, 8.21
 - selection of, 16.6
 - litigation area
 - components of, 5.12
 - separation of, from spectator area, 5.14
 - loading docks
 - finishes for, 11.16
 - mechanical requirements for, 13.12
 - planning and design of, 10.2
 - power requirements for, 15.3
 - security and, 4.7, 4.10, 4.18, 4.25, 4.28, 4.32
 - loading zones, 3.4
 - lobbies
 - background noise criteria for, 19.2
 - ceiling height of, 2.5
 - design of, 9.2–9.5
 - finishes for, 11.16
 - lighting for, 16.3, 16.9
 - occupant density of, 13.4
 - power requirements for, 13.4
 - room acoustics requirements for, 19.3
 - security and, 4.8, 4.9, 4.16, 4.21, 4.24–4.25, 9.3–9.4
 - temperature of, 13.4
 - local area network (LAN), 17.24
 - loudspeakers, 18.4–18.5, 18.6, 18.9, 18.11, 18.12, 18.13
- M**
- mail centers
 - for court administration, 6.10
 - for jury assembly, 6.4
 - mailroom
 - location of, 4.8
 - mechanical requirements for, 13.12
 - planning and design of, 10.3
 - security and, 4.18, 4.25, 4.32
 - size of, 2.9
 - main distribution frame (MDF)
 - definition of, 17.5
 - electronic security systems and, 4.18–4.19
 - fire protection systems for, 20.6–20.7
 - occupant density of, 13.4
 - planning and design of, 17.5–17.7
 - power requirements for, 13.4, 15.3, 17.7
 - security and, 4.32
 - space considerations for, 17.4
 - temperature of, 13.4
 - maintenance shops, 4.32, 10.3
 - massing, 3.5–3.6
 - mats, 11.6–11.7
 - mechanical systems
 - access to, 13.12
 - criteria for, 13.3–13.10
 - energy conservation and, 13.2
 - equipment enclosures for, 10.4
 - flexibility of, for change, 13.2
 - insulation, 13.17
 - isolation of, 13.10, 13.14
 - maintenance of, 13.2
 - performance of, 13.2
 - planning and design of, 13.2
 - reliability of, 13.2
 - requirements for specific spaces, 13.12–13.13
 - security and, 4.14–4.15, 4.26
 - space for, 2.7
 - standby capacity of, 13.2
 - sustainability and, 13.2
 - thermometers and gauges, 13.17–13.18
 - media area
 - exterior, 10.3
 - interior, 10.3
 - security and, 4.32
 - mediation rooms, 7.5
 - metal finishes, 11.16
 - microphones, 18.3, 18.7, 18.8–18.9, 18.11–18.13

mockups, 5.2, 5.4

multipair copper cable, 17.15

multipurpose rooms

- jury assembly rooms as, 6.3
- planning and design of, 7.7–7.8
- security and, 4.31
- uses for, 7.7–7.8

N

natural gas systems, 13.16

net square feet (NSF), 2.6

network and communication systems

- administration and verification, 17.20–17.21
- backbone connectivity, 17.14–17.15
- cabling, 17.2, 17.3
- definition of, 17.2
- distributed antenna systems, 17.25–17.26
- distribution pathways, 17.11–17.14
- horizontal connectivity, 17.15–17.19
- network architecture, 17.2–17.4, 17.21–17.24
- overview of, 17.2–17.4

network architecture, 17.2–17.4, 17.21–17.24

noise. *See also* acoustical design

- background, 19.2
- environmental, 19.7–19.8
- footfall, 19.7

noise isolation class (NIC), 19.4

nonstructural seismic coordinator (NSC), 12.4, 12.5

“No Smoking” signs, 11.20

notice boards, 11.19

O

occupant density, suggested, 13.4

offices

- background noise criteria for, 19.2
- ceiling height of, 2.5
- communications outlets for, 17.14
- for court administration, 6.8
- for court executive officer, 6.7–6.11
- finishes for, 11.16
- floor vibration acceptance criteria for, 12.3
- lighting for, 16.3, 16.8
- occupant density of, 13.4
- open, 19.2, 19.3
- power requirements for, 13.4, 15.3
- room acoustics requirements for, 19.3
- security and, 4.24, 4.31

- size of, 2.8, 2.11
- temperature of, 13.4

optical fiber, 17.14–17.15

outlets, 17.13, 17.16, 17.17

outside air control methods, 14.6

outdoor-indoor transmission class (OITC), 19.6, 19.8

outside plant (OSP) pathways, 17.12

P

paper pass, 8.16, 8.20

parking

- accessible, 3.4
- background noise criteria for, 19.2
- landscape design for, 3.7–3.8
- lighting for, 16.4, 16.10
- planning and design of, 3.2–3.4
- power requirements for, 15.3
- public, 3.2–3.3, 4.7
- secure, 3.3–3.4, 4.7, 4.15, 4.21
- security and, 4.7, 4.21, 4.23

partitions

- interior, 11.10
- operable, 19.7

pedestrian access, 1.4, 3.6

pedestrian pathways, 16.4

pedestrian sally ports, 8.6–8.7, 8.26

perimeter, secure, 8.5

pink noise, 18.3, 18.6, 18.9

piping

- fuel, 13.16
- hangers, 13.10
- identification of, 13.14
- insulation, 13.17
- isolation of, 13.10, 13.14
- planning and design of, 13.13–13.17

pistol lockers, 8.16, 8.20

platforms, 11.14

plenum spaces, 11.9–11.10, 13.5

plumbing systems

- criteria for, 13.13–13.16
- fixtures, 8.22, 13.15–13.16
- insulation, 13.17
- noise reduction and, 19.8–19.10

post indicator valve (PIV) assembly, 20.6

APPENDIXES

Codes and Standards
List of Abbreviations

INDEX

Acknowledgments

- power requirements
 - minimum load, 15.3
 - by room type, 13.4
 - spare capacity, 15.3
 - power systems
 - for detention control system, 8.33
 - emergency and standby, 15.9–15.13
 - new, 15.7–15.8
 - press access. *See* media area
 - pressure gauges, 13.17–13.18
 - pressurization, 13.6
 - programmable logic controllers (PLCs), 8.30
 - propane gas systems, 13.16
 - protection, concentric circles of, 4.5
 - public spaces
 - information kiosk or counter, 9.4–9.5
 - lobby, 9.2–9.5
 - planning and design of, 9.2
 - primary building entrance, 9.2
 - space standards for, 2.9
 - waiting areas, 9.5
 - pump systems, 13.13
 - purchasing, 6.8
- R**
- radiant heating systems, 13.9
 - rainwater drainage system, 13.15
 - ramps, 5.5–5.6, 11.6
 - rare loads, criteria for, 12.4–12.5
 - receiving, 4.18, 4.28
 - reception areas
 - for alternative dispute resolution, 7.7
 - background noise criteria for, 19.2
 - for courtroom support, 2.8, 5.16
 - for Family Court Services, 7.4–7.5
 - for jury assembly areas, 6.2
 - for self-help centers, 7.2–7.3
 - records. *See also* files
 - security and, 4.30
 - storage, 2.8, 4.30, 6.9–6.10
 - viewing, 4.30, 6.7
 - reflectance values, 16.2, 16.5
 - relative humidity, 13.11
 - research attorney work area, 2.8, 5.17
 - restroom facilities
 - for court administration staff, 6.11
 - finishes for, 11.16
 - in in-custody areas, 8.22, 8.24
 - for jury assembly rooms, 6.3
 - lighting for, 16.3, 16.9
 - mechanical requirements for, 13.12
 - occupant density of, 13.4
 - power requirements for, 13.4, 15.3
 - size of, 2.8, 2.9
 - temperature of, 13.4
 - revenue and collections office, 6.8
 - reverberation time, 19.2, 19.3
 - risk assessment procedures, 4.4
 - roofs, 11.7–11.8
 - room acoustics, 19.2–19.4, 19.11
- S**
- safety equipment storage, 8.12–8.13
 - sally ports
 - definition of, 8.4
 - electronic detention control requirements for, 8.33
 - mechanical requirements for, 13.12
 - pedestrian, 8.6–8.7, 8.26, 8.33
 - vehicle, 8.5–8.6, 8.25–8.26, 8.33
 - sanitary waste systems, 13.15–13.16
 - Savings By Design program, 1.8
 - screening stations, 2.9, 4.21, 4.29, 9.3–9.4
 - sealants, 8.23
 - seal of the State of California, 11.15
 - security. *See also individual areas*
 - building envelope and, 4.11–4.12, 4.25, 4.26
 - building layout and, 4.8–4.9, 4.23
 - cable routing, 4.21
 - capability for increasing, 4.4
 - card access control, 4.19
 - challenges to, 4.2
 - duress alarm, 4.20
 - electrical systems and, 4.14–4.15, 4.26
 - electronic security systems, 4.19–4.21, 4.27, 4.28–4.32
 - factors affecting levels of, 4.3–4.4
 - fire protection systems and, 4.14–4.15, 4.26
 - intrusion detection, 4.20
 - lighting, 16.7
 - mechanical systems and, 4.14–4.15, 4.26
 - physical planning criteria, 4.4–4.12
 - planning and design of, 4.2–4.3

protective structural design, 4.10, 4.12–4.13, 4.26

risk assessment procedures, 4.4

screening stations, 2.9, 4.21, 4.29, 9.3–9.4

site design and, 4.5–4.7, 4.23

standards for, 4.23–4.32

turnstiles, 4.21

video surveillance, 4.19–4.20

security operations center

- combined with detention control room, 8.6, 8.7
- lighting for, 16.7, 16.10
- location of, 4.10
- power requirements for, 15.3
- size of, 2.9
- standards for, 4.25, 4.32

self-help centers, 2.9, 4.31, 7.2–7.3, 11.16

self-represented litigants, 7.2–7.3

service entrance facilities, 17.4–17.5, 17.12

service loads, criteria for, 12.2–12.3

setback distance, 4.6–4.8

sewage ejectors, 13.15

shredding, 10.2

signage

- digital, 18.8
- exit, 16.6
- in in-custody areas, 8.24
- for jury assembly rooms, 6.2
- planning and design of, 11.17–11.20

single-mode fiber (SMF) cable, 17.14–17.15

site design

- security and, 4.5–4.7, 4.23

snow, 12.2, 12.5

sound isolation, 13.10, 19.2, 19.4–19.5, 19.6, 19.10–19.11

sound masking, 18.3, 18.6

sound transmission class (STC), 19.4–19.5

space standards, 2.5–2.6, 2.8–2.12

special services

- alternative dispute resolution, 7.6–7.7
- children’s waiting room, 7.6
- Family Court Services, 7.3–7.6
- family law facilitators, 7.2–7.3
- multipurpose rooms and offices, 7.7–7.8
- offices for related justice agencies, 7.7
- self-help centers, 7.2–7.3

spectator area

- lighting for, 16.3
- planning and design of, 5.14–5.15
- security and, 4.29
- separation of, from litigation area, 5.14

speech and reinforcement systems, 18.3, 18.6

speech privacy, 19.4, 19.10–19.11

sprinkler systems

- cleaning, 20.7
- coordination of, 20.7
- criteria for, 20.2–20.7
- in in-custody areas, 8.22
- for MDF/server equipment room, 20.6–20.7
- pipng requirements, 20.4–20.5
- sprinkler control valves, 20.6
- sprinkler head guards, 20.3
- sprinkler head requirements, 20.6
- valve requirements, 20.5

stairs

- exterior, 11.6
- finishes for, 11.16
- floor vibration acceptance criteria for, 12.3
- for in-custody areas, 8.33
- lighting for, 16.4, 16.8
- planning and design of, 11.12
- for private circulation system, 2.4–2.5

standby power systems, 15.9–15.13

state seal, 11.15

storage

- for building support services, 10.3
- for court administration, 6.9–6.10, 6.11
- for evidence and exhibits, 2.8, 4.10, 4.17, 4.25, 4.30, 5.15
- for Family Court Services, 7.4, 7.6
- finishes for, 11.16
- in holding areas, 8.12–8.13
- occupant density of, 13.4
- power requirements for, 15.3
- for records, 2.8, 4.17, 4.25, 4.30, 6.9–6.10
- for safety equipment, 8.12–8.13
- security and, 4.32
- size of, 2.8, 2.9

striplights, 16.9

structural design

- adaptability and, 12.2
- criteria for, 12.2–12.5
- goals for, 12.2
- life cycle cost analysis and, 12.4, 12.6
- rare events and, 12.2
- serviceability and, 12.2

APPENDICES

Codes and Standards
List of Abbreviations

INDEX

Acknowledgments

surge protective devices, 15.8

surveillance
 natural, 4.4, 4.5, 4.8
 video, 4.19–4.20, 8.31

sustainability
 audiovisual systems and, 18.2
 design criteria and performance goals for, 1.6–1.8
 energy savings programs, 1.8
 landscape design and, 3.7–3.8
 life cycle cost analysis and, 1.6
 mechanical systems and, 13.2
 objectives for, 1.6

T

telecommunications
 finishes for, 11.16
 security and, 4.32
 space standards for, 2.9

temperature control, 13.3

territoriality, 4.4, 4.5

thermometers, 13.17–13.18

toilets. *See* restroom facilities

training rooms
 allocating space for, 6.10
 audiovisual system requirements for, 18.12–18.13
 background noise criteria for, 19.2
 for Family Court Services, 7.5
 jury assembly rooms as, 6.3
 lighting for, 16.10
 room acoustics requirements for, 19.3
 security and, 4.30
 size of, 2.8, 6.10
 standards for, 6.10

transcription, real-time, 18.10

transient voltage surge suppressor (TVSS) units, 15.8

trash and recycling area, 2.9, 4.32

turnstiles, 4.21

TV, 18.7. *See also* media area

U

Universal Design principles, 1.3–1.4

UPS (uninterruptible power supply), 15.12–15.13, 17.4

utilities
 location and visibility of, 3.6–3.7
 security and, 4.14

V

vehicle sally ports, 8.5–8.6, 8.25–8.26, 8.33

veneer panels, 11.17

ventilation, 13.3, 13.6. *See also* HVAC

vibration, 13.10

victim waiting areas, 7.8

video
 display systems, 18.6
 surveillance, 4.19–4.20, 8.31

volunteer convenience centers, 7.7

W

waiting areas/rooms
 for alternative dispute resolution, 7.7
 children's, 4.17, 4.24, 4.31, 7.6, 11.16
 for interpreters, 7.8
 for law enforcement, 2.8, 7.7–7.8
 lighting for, 16.3
 occupant density of, 13.4
 power requirements for, 13.4
 public, 9.5
 security and, 4.9–4.10, 4.16, 4.24–4.25, 4.29–4.31
 for self-help centers, 7.2–7.3
 size of, 2.8, 2.9
 temperature of, 13.4
 for victims, 7.8
 for witnesses, 5.18

walk-off mats and grilles, 11.6–11.7

wall coverings, 11.16

walls
 barrier, 11.3–11.4
 drainage plane, 11.3–11.4
 exterior, 11.3–11.7
 in in-custody areas, 8.14–8.15
 recommended reflectance for, 16.5
 security and, 4.12

waste systems, 13.15–13.16

water
 cold, 13.14
 conservation, 1.7
 flow measuring devices, 13.18
 hammer arrestors, 13.14
 hot, 13.9, 13.14
 treatment, 13.10–13.11

wayfinding, 1.4–1.5, 18.8

weapons
lockers for, 8.16, 8.20
screening for, 4.21, 4.29

wide area network (WAN), 17.24

wind, 11.2–11.3, 12.5

window coverings, 11.14

windows
planning and design of, 11.5–11.6
security and, 4.11, 4.12, 4.21, 4.28
washing, 11.8–11.9

wireless access point (WAP), 17.16

wireless local area network (WLAN), 17.16

witness boxes
communications outlets for, 17.17
lighting for, 16.3
planning and design of, 5.9–5.10

witness waiting areas, 5.18

workplace environment, enhancing, 11.9

workshop rooms, 7.3

workstations
DCS, 8.28
design and planning of, 6.5–6.7
size of, 2.8–2.10

DRAFT

APPENDICES

Codes and Standards
List of Abbreviations

INDEX

Acknowledgments

DRAFT

APPENDIXES

ACKNOWLEDGMENTS

DRAFT

JUDICIAL COUNCIL OF CALIFORNIA

Hon. Patricia Guerrero

Chief Justice of California and Chair of the Judicial Council of California

Hon. Carol A. Corrigan

Associate Justice of the Supreme Court of California

Hon. Brad R. Hill

Administrative Presiding Justice of the Court of Appeal, Fifth Appellate District

Hon. Carin T. Fujisaki

Associate Justice of the Court of Appeal, First Appellate District, Division Three

Hon. Marla O. Anderson

Judge of the Superior Court of California, County of Monterey

Hon. Maria Lucy Armendariz

Judge of the Superior Court of California, County of Los Angeles

Hon. C. Todd Bottke

Judge of the Superior Court of California, County of Tehama

Hon. Kyle S. Brodie

Judge of the Superior Court of California, County of San Bernardino

Hon. Jonathan B. Conklin

Judge of the Superior Court of California, County of Fresno

Hon. Michelle Williams Court

Judge of the Superior Court of California, County of Los Angeles

Hon. Charles S. Crompton

Judge of the Superior Court of California, County of San Francisco

Hon. Samuel K. Feng

Judge of the Superior Court of California, County of San Francisco

Hon. Maureen F. Hallahan

Assistant Presiding Judge of the Superior Court of California, County of San Diego

Hon. Ann C. Moorman

Judge of the Superior Court of California, County of Mendocino

Legislature

Hon. Brian Maienschein

Member of the California State Assembly

Hon. Thomas J. Umberg

Member of the California State Senate

State Bar

Mr. David D. Fu

Attorney at Law

Ms. Rachel W. Hill

Attorney at Law

Ms. Gretchen Nelson

Attorney at Law

Mr. Maxwell V. Pritt

Attorney at Law

Advisory Members

Ms. Kate Bieker
Court Executive Officer, Superior Court of California, County of Contra Costa

Hon. Judith K. Dulcich
Judge of the Superior Court of California, County of Kern

Hon. Maria D. Hernandez
Presiding Judge of the Superior Court of California, County of Orange

Mr. Charles Johnson
Clerk/Executive Officer, Court of Appeal, First Appellate District

Mr. Darrel E. Parker
Court Executive Officer, Superior Court of California, County of Santa Barbara

Mr. David H. Yamasaki
Court Executive Officer, Superior Court of California, County of Orange

Hon. Erica R. Yew
Judge of the Superior Court of California, County of Santa Clara

Secretary

Ms. Millicent Tidwell
Acting Administrative Director

COURT FACILITIES ADVISORY COMMITTEE (CFAC)

Hon. Brad R. Hill, Chair
Administrative Presiding Justice of the Court of Appeal, Fifth Appellate District

Hon. Patricia M. Lucas (Ret.), Vice-Chair
Judge of the Superior Court of California, County of Santa Clara

Hon. Donald Cole Byrd
Presiding Judge of the Superior Court of California, County of Glenn

Hon. JoAnn M. Bicego
Presiding Judge of the Superior Court of California, County of Siskiyou

Mr. Anthony P. Capozzi
Attorney at Law

Hon. Robert D. Foiles
Judge of the Superior Court of California, County of San Mateo

Ms. Melissa Fowler-Bradley
Court Executive Officer, Superior Court of California, County of Shasta

Hon. William F. Highberger
Judge of the Superior Court of California, County of Los Angeles

Hon. Steven E. Jahr (Ret.)
Judge of the Superior Court of California, County of Shasta

Hon. Patricia L. Kelly
Assistant Presiding Judge of the Superior Court of California, County of Santa Barbara

Ms. Krista LeVier
Court Executive Officer, Superior Court of California, County of Lake

Hon. Gary R. Orozco
Judge of the Superior Court of California, County of Fresno

APPENDICES

Codes and Standards
List of Abbreviations
Index

ACKNOWLEDGMENTS

Hon. David Edwin Power (Ret.)
Judge of the Superior Court of California, County of Solano

Mr. Lee Seale
Court Executive Officer, Superior Court of California, County of Sacramento

Mr. Larry Spikes
Former County Administrative Officer, County of Kings

Hon. Robert J. Trentacosta
Judge of the Superior Court of California, County of San Diego

Mr. Thomas J. Warwick, Jr.
Attorney at Law

The Judicial Council acknowledges the contributions of the following committee members, staff, and consultant firms for their input and guidance during the creation of the 2023 edition of the *California Trial Court Facilities Standards*.

CFAC STANDARDS WORK GROUP

Hon. Patricia M. Lucas (Ret.), Chair
Judge of the Superior Court of California, County of Santa Clara

Ms. Melissa Fowler-Bradley
Court Executive Officer, Superior Court of California, County of Shasta

Hon. William F. Highberger
Judge of the Superior Court of California, County of Los Angeles

Hon. Steven E. Jahr (Ret.)
Judge of the Superior Court of California, County of Shasta

JUDICIAL COUNCIL STAFF

Ms. Pella McCormick
Director, Facilities Services

Mr. Tamer Ahmed
Deputy Director, Facilities Services

Ms. Deepika Padam
Manager, Quality Compliance, Facilities Services

Ms. Maggie W. Stern
Attorney, Real Estate, Legal Services

Ms. Karen Gernand
Communications Editor, Editing and Graphics, Leadership Support Services

Ms. Patricia Valentine
Communications Editor, Editing and Graphics, Leadership Support Services

Facilities Services staff at large

CONSULTANT FIRMS

BPR Consulting Group
Architecture, Fire Protection, and Structural Engineering

Frank M. Booth, Inc.
Mechanical Engineering

Gensler
Graphic Design

Nacht & Lewis
Occupancy and Exiting Study

The Engineering Enterprise
Electrical Engineering

Vanir Construction Management, Inc.
Engineering and Knowledge Sharing

DRAFT

APPENDICES

Codes and Standards
List of Abbreviations
Index

ACKNOWLEDGMENTS